

FM 3-39.40

INTERNMENT AND RESETTLEMENT OPERATIONS

February 2010

DISTRIBUTION RESTRICTION: Distribution authorized to the DOD and DOD contractors only to protect technical or operational information from automatic dissemination under the International Exchange Program or by other means. This determination was made on 8 December 2008. Other requests for this document must be referred to the Commandant, U.S. Army Military Police School, ATTN: ATZT-TDD-M, 320 MANSCEN Loop, Suite 270, Fort Leonard Wood, Missouri 65473-8929.

DESTRUCTION NOTICE: Destroy by any method that will prevent disclosure of contents or reconstruction of the document.

HEADQUARTERS, DEPARTMENT OF THE ARMY

This publication is available at
Army Knowledge Online (www.us.army.mil) and
General Dennis J. Reimer Training and Doctrine
Digital Library at (www.train.army.mil).

Internment and Resettlement Operations

Contents

		Page
	PREFACE	viii
	INTRODUCTION	xi
Chapter 1	INTERNMENT AND RESETTLEMENT AND THE OPERATIONAL ENVIRONMENT	1-1
	Conduct	1-1
	Principles	1-3
	Personnel Categories	1-5
	Status Determination	1-7
	Article 5 Tribunals	1-8
	Appeals and Periodic Reviews of Civilian Internees	1-9
	General Protection and Care of Detainees, U.S. Military Prisoners, and Dislocated Civilians	1-10
	Agencies Concerned With Internment and Resettlement	1-12
	Protecting Power	1-13
	Planning Considerations for Internment and Resettlement Operations	1-14
	Military Police Capabilities	1-16
Chapter 2	INTERNMENT AND RESETTLEMENT IN SUPPORT OF THE SPECTRUM OF OPERATIONS	2-1
	Support to Combat Operations	2-1
	Support to Stability Operations	2-3
	Support to Civil Support Operations	2-8
	Army Command and Support Relationships	2-8
	Considerations Within the Operational Area and the Area of Operations	2-9
Chapter 3	COMMAND AND STAFF ROLES AND RESPONSIBILITIES	3-1
	National and Theater Reporting Agencies	3-1
	Roles and Responsibilities	3-2

DISTRIBUTION RESTRICTION: Distribution authorized to the DOD and DOD contractors only to protect technical or operational information from automatic dissemination under the International Exchange Program or by other means. This determination was made on 8 December 2008. Other requests for this document must be referred to the Commandant, U.S. Army Military Police School, ATTN: ATZT-TDD-M, 320 MANSCEN Loop, Suite 270, Fort Leonard Wood, Missouri 65473-8929.

*This publication supersedes FM 3-19.40, 4 September 2007.

	Joint Interrogation and Debriefing Center Commander/Military Intelligence Battalion	3-7
	Intelligence Analysts	3-8
	Human Intelligence Collectors	3-8
	Interpreters and Translators.....	3-9
	Military Police Organizations in Support of Internment and Resettlement	
	Operations.....	3-10
	Staff Duties and Responsibilities in Support of Internment and Resettlement	3-12
	Guard Force	3-18
Chapter 4	CAPTURE, INITIAL DETENTION, AND SCREENING	4-1
	Detainee Flow	4-1
	Detainee Processing	4-5
	Custody and Accountability of Property, Evidence, and Intelligence	
	Information	4-12
	Detainee Movement.....	4-15
	Methods of Transportation	4-16
	Detainee Release.....	4-19
Chapter 5	DETAINEE OPERATIONS	5-1
	Command and Control.....	5-1
	Planning Considerations	5-2
	Intelligence and Interrogation.....	5-3
	Medical Support	5-6
	Dental Support	5-8
	Specific Detainee Support Requirements	5-9
	Detainee Deaths	5-13
	Legal Considerations	5-14
Chapter 6	DETAINEE FACILITIES	6-1
	General Considerations	6-1
	Detainee Collection Point.....	6-4
	Detainee Holding Area.....	6-10
	Fixed Detainee Internment Facilities.....	6-14
	Theater Internment Facility	6-17
	Strategic Internment Facility	6-37
	Transfers or Releases.....	6-38
Chapter 7	CONFINEMENT OF U.S. MILITARY PRISONERS	7-1
	U.S. Battlefield Confinement Operations Principles	7-1
	Planning Process for U.S. Military Prisoners	7-1
	Battlefield Facilities	7-2
	Processing, Classification, and Identification Requirements	7-3
	Clothing, Meals, and Dining Facilities	7-4
	Medical Care and Sanitation.....	7-5
	Discipline, Control, and Administration	7-6
	Emergency Planning and Investigations.....	7-11
	Rules of Interaction	7-12
	Use of Force.....	7-12
	Escape	7-12

	Transportation	7-13
	Transfer and Disposition of U.S. Military Prisoners	7-13
Chapter 8	REHABILITATION OF U.S. MILITARY PRISONERS AND DETAINEES	8-1
	Rehabilitation.....	8-1
	Section I – U.S. Military Prisoners	8-2
	Programs.....	8-2
	Disposition Boards	8-2
	Section II – Detainees	8-7
	Programs.....	8-7
	Rehabilitation Programs.....	8-10
Chapter 9	PAROLE, TRANSFER, OR RELEASE OF U.S. MILITARY PRISONERS AND DETAINEES	9-1
	Release of U.S. Military Prisoners	9-1
	Release or Transfer of Detainees	9-5
	Transition of Detainee Operations to Civil Authority Penal Systems	9-9
Chapter 10	RESETTLEMENT OPERATIONS	10-1
	Introduction.....	10-1
	Objectives and Considerations	10-1
	Civil-Military and Resettlement Operations.....	10-2
	Responsibilities for Civil Affairs Activities.....	10-2
	Supporting Organizations.....	10-6
	Planning Considerations	10-6
	Military Police Support to Resettlement Operations	10-9
	Dislocated Civilian Operations	10-11
Appendix A	METRIC CONVERSION CHART.....	A-1
Appendix B	PRIMARY MILITARY POLICE UNITS INVOLVED WITH INTERNMENT AND RESETTLEMENT	B-1
Appendix C	CONTRACTOR SUPPORT	C-1
Appendix D	THE APPLICATION OF THE GENEVA CONVENTIONS TO INTERNMENT AND RESETTLEMENT OPERATIONS.....	D-1
Appendix E	AGENCIES CONCERNED WITH INTERNMENT AND RESETTLEMENT OPERATIONS.....	E-1
Appendix F	SAMPLE FACILITY INSPECTION CHECKLIST	F-1
Appendix G	INTERNMENT AND RESETTLEMENT FORMS.....	G-1
Appendix H	USE OF FORCE AND RIOT CONTROL MEASURES	H-1
Appendix I	MEDICAL SUPPORT TO DETAINEE OPERATIONS	I-1
Appendix J	FACILITY DESIGNS AND SUSTAINMENT CONSIDERATIONS	J-1
Appendix K	PSYCHOLOGICAL OPERATIONS SUPPORT TO INTERNMENT AND RESETTLEMENT OPERATIONS	K-1
Appendix L	GUIDELINES FOR HANDLING EVIDENCE	L-1
Appendix M	BIOMETRICS.....	M-1
Appendix N	FOREIGN CONFINEMENT OFFICER TRAINING PROGRAM	N-1

GLOSSARY **Glossary-1**
REFERENCES..... **References-1**
INDEX **Index-1**

Figures

Figure 1-1. I/R populations..... 1-2
Figure 4-1. Detainee flow 4-2
Figure 4-2. POC to TIF detainee flow 4-3
Figure 4-4. Movement by bus 4-16
Figure 4-5. Movement by cargo truck 4-16
Figure 4-6. Movement by rail 4-17
Figure 4-7. Movement by CH-47 and UH-60 4-17
Figure 4-8. Movement by C-130 aircraft 4-18
Figure 6-1. Bed-down and basing continuum 6-2
Figure 6-2. Example of a DCP layout 6-5
Figure 6-3. C2 within the BCT and the DCP 6-6
Figure 6-4. Example of a DHA 6-10
Figure 6-5. C2 within the division and DHA 6-11
Figure 6-6. ISN 6-16
Figure 6-7. Sample TIF C2 in the theater with single or multiple small TIFs 6-18
Figure 6-8. Sample TIF C2 in the theater with an MPC and multiple TIF 6-19
Figure 9-1. Detainee reintegration considerations 9-9
Figure 10-1. Sample facility rules 10-14
Figure D-1. Common Article 3 to the Geneva Conventions D-2
Figure F-1. Sample internment facility inspection checklist F-1
Figure F-1. Sample internment facility inspection checklist (continued) F-3
Figure H-1. Use-of-force continuum H-2
Figure J-1. 4,000-capacity I/R facility for compliant detainees J-2
Figure J-2. 8,000-capacity I/R facility for DCs J-3
Figure J-3. 300-capacity I/R facility for U.S. military prisoners or noncompliant detainees J-4
Figure J-4. 500-person compound J-7
Figure J-5. Detainee receiving and processing operation J-10
Figure J-6. Clothing markings J-16

Tables

Table 4-1. Detainee operations functional overview	4-6
Table 4-2. POC processing standards	4-9
Table 5-1. Military police versus HUMINT responsibilities	5-4
Table 6-1. Nine-station internment process	6-22
Table 6-2. Detainee transfer or release process from a TIF/SIF	6-39
Table 6-2. Detainee transfer or release process from a TIF/SIF (continued)	6-40
Table 7-1. Facility guards' duties and actions	7-9
Table 7-2. Good conduct time	7-10
Table 9-1. The detainee release process from long-term detention	9-7
Table 10-1. Actions during inprocessing	10-10
Table A-1. Metric conversion chart	A-1
Table G-1. I/R forms	G-1
Table J-1. Sample individual equipment	J-17

Preface

Field manual (FM) 3-39.40 is aligned with FM 3-39, the military police keystone FM. FM 3-39.40 provides guidance for commanders and staffs on internment and resettlement (I/R) operations. This manual addresses I/R operations across the spectrum of conflict, specifically the doctrinal paradigm shift from traditional enemy prisoner of war (EPW) operations to the broader and more inclusive requirements of detainee operations.

Additionally, FM 3-39.40 discusses the critical issue of detainee rehabilitation. It describes the doctrinal foundation, principles, and processes that military police and other elements will employ when dealing with I/R populations. As part of internment, these populations include U.S. military prisoners, and multiple categories of detainees (civilian internees [CIs], retained personnel [RP], and enemy combatants), while resettlement operations are focused on multiple categories of dislocated civilians (DCs).

Military police conduct I/R operations during offensive, defensive, stability, or civil support operations. I/R operations include military police support to U.S. military prisoner and detainee operations within operational environments (OEs), ranging from major combat operations to humanitarian-assistance missions in support of a host nation (HN) or civil agency. I/R operations are a major subordinate Army tactical task under the sustainment warfighting function. (See FM 7-15.) Placement under the sustainment warfighting function does not mean that I/R operations do not have relevance in the other warfighting functions. While I/R is listed under the sustainment warfighting function, it should be noted this is not a specified or implied mission of all sustainment units or commands. Most sustainment units provide logistics, personnel services, and health service support to I/R operations.

Military police are uniquely qualified to perform the full range of I/R operations. They have the requisite skill sets provided through specific training and operational experience. The skills necessary for performing confinement operations for U.S. military prisoners in permanent facilities are directly transferable and adaptable for tactical confinement of U.S. military prisoners and detention of detainees. All military police units are specifically manned, equipped, and trained to perform I/R operations across the spectrum and those identified as I/R units are the specialists within the Army for this role.

FM 3-39.40 depicts the changes in terminology from the focus on the contiguous battlefield to reflect the types of operations being conducted in today's OEs. These changes address the modifications made to previous EPW processing operations. The terms *division forward*, *central collection point*, and *corps holding area* no longer apply. They have been replaced with the terms *detainee collection point (DCP)* (brigade level), *detainee holding area (DHA)* (division level), *theater internment facility (TIF)*, and *strategic internment facility (SIF)*. This manual recognizes the role of police intelligence operations in I/R operations and enhances the critical importance of military police and military intelligence interaction at all echelons. It further highlights the long-standing requirement to treat all individuals humanely according to applicable U.S. laws and regulations, international laws, execution orders, fragmentary orders (FRAGOs), and other operationally specific guidelines such as Department of Defense (DOD) policies. Moreover, it stipulates that ill treatment of U.S. military prisoners, detainees (EPWs, CIs, and RP), and DCs is strictly prohibited, regardless of any circumstances or the chaos of major operations.

FM 3-39.40 aligns with FM 3-0, FM 3-39, FM 7-15, and other Army and joint doctrine, to include Joint Publication (JP) 3-63. This manual is organized into 10 chapters with 14 appendixes to provide additional details on I/R topics. Chapters 1 through 3 follow the flow of FM 3-39, and describe the military police function of I/R operations. Chapters 4 through 6 focus primarily on detainee operations, to include planning, preparing, executing, and sustaining all I/R operations. Chapters 7 through 10 focus on the confinement of U.S. military prisoners, rehabilitative programs for U.S. military prisoners and detainees, parole and release or transfer programs, and resettlement operations for DCs. A brief description of each chapter and appendix follows:

- Chapter 1 defines the objectives and principles of I/R operations and describes U.S. policies on the protection and care of all detainees, U.S. military prisoners, and DCs. It also emphasizes the fundamental requirement for the humane treatment of all persons captured, held, assisted, or otherwise under the control of DOD personnel, regardless of their individual status.

- Chapter 2 provides a description of I/R in support of operations across the spectrum of conflict. It examines the OE and the significant importance of I/R to tactical, operational, and strategic operations. Additionally, it discusses the importance of integrating detainee operations within the overarching efforts in major engagements.
- Chapter 3 discusses command and staff roles and their respective responsibilities in resourcing and synchronizing the efforts of multidisciplined functions and personnel. Clear command and control (C2) is essential for seamless operations to ensure that the principles of I/R operations are realized.
- Chapter 4 focuses on detainee operations planning and considerations. It includes a discussion on integrating intelligence and interrogation operations. Emphasis is placed on the treatment and protection of detainees, use of force, and training for detainee operations.
- Chapter 5 provides information on the capture and initial detention and screening of detainees.
- Chapter 6 discusses facility infrastructure considerations at all levels. Successful operations include the effective incorporation of sustainment support. This chapter describes the integrated sustainment effort required to support I/R operations.
- Chapter 7 discusses the confinement of U.S. military prisoners, to include battlefield and nonbattlefield confinement.
- Chapter 8 provides a discussion of the rehabilitative processes for confined U.S. military prisoners and detainees, to include effective measures that ensure a successful return to society.
- Chapter 9 addresses the processes of paroling, transferring, or releasing U.S. military prisoners and detainees.
- Chapter 10 provides an overview of resettlement operations for DCs. It describes the objectives and principles, supporting organizations, and military police support of resettlement operations.
- Appendix A is a metric conversion chart that is included according to Army Regulation (AR) 25-30.
- Appendix B identifies military police units with I/R capabilities that may be assigned to the theater of operations.
- Appendix C describes requirements and activities associated with the employment of contractors during support to detainee operations.
- Appendix D describes the intent of the protections given by each of the four Geneva Conventions, the different categories of individuals under these treaties as required by international humanitarian law, and the requirement to establish a tribunal to determine the status of an individual in question.
- Appendix E provides background information and considerations for operating with the various agencies typically concerned with I/R operations.
- Appendix F provides a sample facility checklist for planning considerations when conducting detainee operations at the TIF or SIF.
- Appendix G consists of forms used when processing and maintaining I/R populations.
- Appendix H provides guidance for applying the rules for use of force (RUF) and implementing nonlethal weapons (NLWs) and riot control measures.
- Appendix I outlines health support to be provided during I/R operations.
- Appendix J provides guidance for the design and construction of I/R facilities and the associated sustainment requirements for establishing I/R facilities.
- Appendix K describes the psychological operations (PSYOP), practices, and procedures to support I/R operations.
- Appendix L provides general guidelines for the handling of captured material and documents that could be used as evidence in legal proceedings against captured persons suspected of crimes against humanity, terrorism, war crimes, and other crimes.
- Appendix M addresses biometrics and military police considerations for their use in I/R operations and facility management.

Preface

- Appendix N provides tactics, techniques, and procedures for establishing and maintaining a foreign confinement officer training program.

Definitions for which FM 3-39.40 is the proponent publication (the authority) are in boldfaced text and have an asterisk in the glossary. These terms and their definitions will be incorporated into the next revision of FM 1-02. For other definitions in the text, the term is italicized and the number of the proponent publication follows the definition.

This publication applies to the Active Army, the Army National Guard/the Army National Guard of the United States, and the U.S. Army Reserve unless otherwise stated.

The proponent for this publication is the U.S. Army Training and Doctrine Command. Send comments and recommendations on Department of the Army (DA) Form 2028 (*Recommended Changes to Publications and Blank Forms*) directly to Commandant, U.S. Army Military Police School, ATTN: ATZT-TDD-M, 320 MANSCEN Loop, Suite 270, Fort Leonard Wood, Missouri 65473-8929. Submit an electronic DA Form 2028 or comments and recommendations in the DA Form 2028 format by e-mail to <leon.mdottddmpdoc@conus.army.mil>.

Introduction

I/R operations facilitate the ability to conduct rapid and decisive combat operations; deter, mitigate, and defeat threats to populations that may result in conflict; reverse conditions of human suffering; and build the capacity of a foreign government to effectively care for and govern its population. This includes capabilities to conduct shaping operations across the spectrum of military operations to mitigate and defeat the underlying conditions for conflict and counter the core motivations that result in support to criminal, terrorist, insurgent, and other destabilizing groups. I/R operations also include the daily incarceration of U.S. military prisoners at facilities throughout the world.

This manual continues the evolution of the I/R function to support the changing nature of OEs. In light of persistent armed conflict and social turmoil throughout the world, the effects on populations remain a compelling issue. The world population will increase from 6 billion to 9 billion in the next two decades, with 95 percent of the growth occurring in the developing world. By 2030, 60 percent of the world's population will live in urban areas. Coexisting demographically and ethnically, diverse societies will aggressively compete for limited resources.

Typically, overpopulated third world societies suffer from a lack of legitimate and effective enforcement mechanisms, which is generally accepted as one of the cornerstones of a stable society. Stability within a population may eliminate the need for direct military intervention. The goal of military police conducting detainee operations is to provide stability within the population, its institutions, and its infrastructure. In this rapidly changing and dynamic strategic environment, U.S. forces will compete with local populations for the same space, routes, and resources. The modular force's ability to positively influence and shape the opinions, attitudes, and behaviors of select populations is critical to tactical, operational, and strategic success.

An adaptive enemy will manipulate populations that are hostile to U.S. intent by instigating mass civil disobedience, directing criminal activity, masking their operations in urban and other complex terrain, maintaining an indistinguishable presence through cultural anonymity, and actively seeking the traditional sanctuary of protected areas as defined by the rules of land warfare. Such actions will facilitate the dispersal of threat forces, negate technological overmatches, and degrade targeting opportunities. Commanders will use technology and conduct police intelligence operations to influence and control populations, evacuate detainees and, conclusively, transition rehabilitative and reconciliation operations to other functional agencies. The combat identification of friend, foe, or neutral is used to differentiate combatants from noncombatants and friendly forces from threat forces.

FM 3-39.40 is written with the acknowledgement that today's OEs are much more variable than the environments addressed in previous doctrine. Military police must be prepared to deploy into any OE and conduct I/R operations in support of the commander while dealing with a wide range of threats and other influences. This manual builds on the collective knowledge and wisdom gained through recent operations, numerous lessons learned, doctrine revisions, and the deliberate process of informed reasoning throughout the Army. It is rooted in time-tested principles and fundamentals, while accommodating new technologies and organizational changes.

This iteration of FM 3-39.40 has been driven by a lack of existing doctrine for the rehabilitation and reconciliation of detainees and changes in OEs, the Army structure, and Army and joint doctrine. Changes not already mentioned above that have directly affected this manual include the—

- Integration of I/R operations within the overarching counterinsurgency or irregular warfare efforts of current operations.
- Development of terms of reference for detainee typology and standardization of procedures for detainee assessment.

Note. Recent decisions by the Executive Branch have adjusted the typology in JP 3-63.

Introduction

- Implementation of standardized programs and methods for rehabilitation, reconciliation, and repatriation of detainees.
- Planning, employment, and sustainment of military police capabilities in support of all echelons while conducting I/R operations.
- Alignment of I/R operations with the sustainment warfighting function.
- Technological and doctrinal updates to material in other publications.

The foundations of military police operations provided in this manual, together with related military police doctrine, will support the actions and decisions of commanders at all levels. Like FM 3-39, this manual is not meant to be a substitute for thought and initiative among military police leaders and Soldiers. No matter how robust the doctrine or advanced the military police capabilities and systems, it is the military police Soldier who must understand the OE, recognize shortfalls, and adapt to the situation on the ground. It is the adaptable and professional military police Soldiers of the Military Police Corps Regiment who are most important to the future and must successfully perform their basic skills to accomplish the mission, with or without technology assistance.

Chapter 1

Internment and Resettlement Operations and the Operational Environment

I/R operations include a complex set of activities with diverse requirements that require clear and concise guidelines, policies, and procedures to ensure success. They are present to one degree or another in every OE. (For a greater understanding of the OE, its variables, and the effect of I/R operations on the OE see FM 3-0 and FM 3-39.) Military police leaders and Soldiers conducting I/R operations must maintain task proficiency for every category of detainee, U.S. military prisoner, and DC to ensure adherence to relevant standards for each. The expanding complexity and challenging nature of I/R operations must be appreciated and understood. This chapter defines the objectives and principles of I/R operations and describes U.S. policies on the protection and care of all detainees, U.S. military prisoners, and DCs. It emphasizes the fundamental requirement for the humane treatment of all persons captured, held, assisted, or otherwise under the control of DOD personnel (military, civilian, or contractor), regardless of their individual status. This chapter provides key definitions set forth by Geneva Convention I for the Amelioration of the Condition of the Wounded and Sick in Armed Forces in the Field (GWS), Geneva Convention II for the Amelioration of the Condition of Wounded, Sick and Shipwrecked Members of Armed Forces at Sea (GWS SEA), Geneva Convention III Relative to the Treatment of Prisoners of War (GPW), and Geneva Convention IV Relative to the Protection of Civilian Persons in Time of War (GC); the Hague Conventions; Department of Defense directives (DODDs), Department of Defense instructions (DODI), and policies; Army regulations (ARs); and the Uniform Code of Military Justice (UCMJ). It also explains the diverse nature of I/R populations that military police will encounter and specific requirements for various I/R operations. AR 190-47 stipulates that U.S. military prisoners have additional standards of care given their specific rights as U.S. citizens and will be confined separately from detainees. Specific detainee classifications do not preclude protections granted according to AR 190-8, DODD 2310.01E, DODD 2311.01E, DODD 3115.09, and the Geneva Conventions. (See JP 3-63 for more information on detainee operations.)

CONDUCT

1-1. I/R operations include the two major categories of internment operations and resettlement operations. They are further refined to focus on specific types of detainees and U.S. military prisoners while discriminating between CIs included as part of internment operations and those DCs that may be retained as part of resettlement operations. (See chapter 10.) Figure 1-1, page 1-2, highlights the different categories of I/R populations.

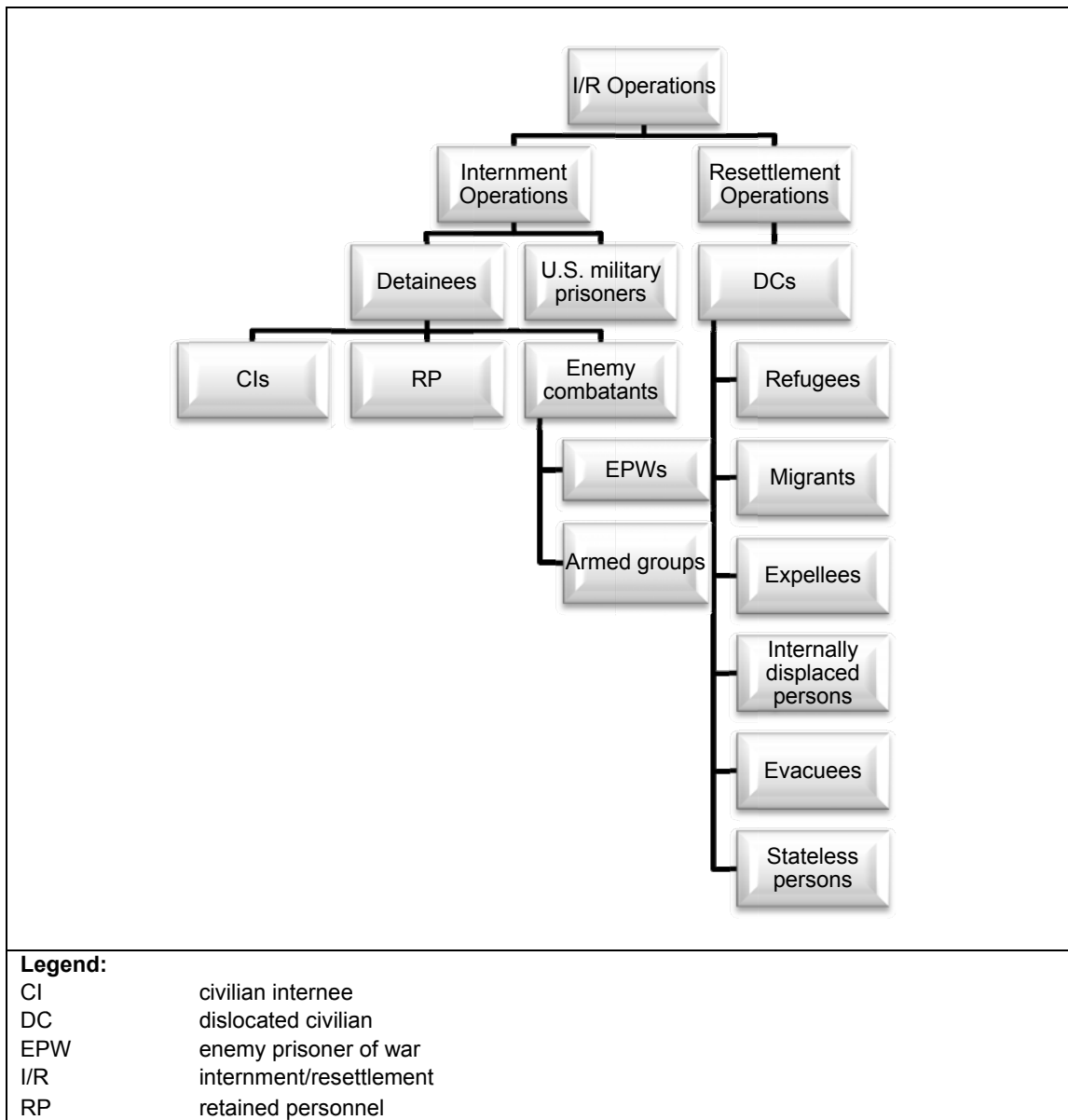

Figure 1-1. I/R populations

1-2. Internment operations focus on all types of detainees and U.S. military prisoners. Although a part of internment operations, we use the term *confinement* rather than internment when referring to U.S. military prisoners. Resettlement operations are focused on DCs (those civilians that are not part of the population of detainees).

1-3. *Internment and resettlement operations* are conducted by military police to shelter, sustain, guard, protect, and account for populations (detainees, U.S. military prisoners, or dislocated civilians) as a result of military or civil conflict, natural or man-made disaster, or to facilitate criminal prosecution. Internment involves the detainment of a population or group that pose some level of threat to military operations. Resettlement involves the quartering of a population or group for their protection. These operations inherently control the movement and activities of their specific population for imperative reasons of security, safety, or intelligence gathering. I/R operations require detailed advanced planning to provide a safe and secure environment. U.S. policies mandate that in addition to U.S. military prisoners, all individuals captured, interned, evacuated, or held by U.S. armed

policy applies from the moment they are under the control of U.S. armed forces until they are released, repatriated, or resettled. U.S. military prisoners will be released via one of following three methods:

- Prisoners without discharges will be returned to their units for duty or administrative discharge proceedings after they have completed their sentence to confinement.
- Prisoner may be paroled (early release with conditions).
- Prisoners may be under mandatory, supervised release (release at the end of confinement, but with conditions tantamount to parole).

1-4. AR 190-8 and DODD 2310.01E articulate policy for I/R operations. AR 190-8 embodies U.S. military obligations drawn from, in part, the Geneva Conventions, Hague Conventions, Convention Relating to the Status of Refugees, Geneva Protocol I Relating to the Protection of Victims of International Armed Conflicts, and current North Atlantic Treaty Organization (NATO) standardization agreements. Guidance for U.S. military prisoners is presented in AR 190-47 and DODD 1325.04.

Note. The United States has signed, but not ratified, Geneva Protocol I and Protocol II relating to the Protection of Victims of Non-International Armed Conflicts to the Geneva Conventions and, therefore, is not explicitly bound by their terms. U.S. laws and policies will apply while the U.S. continues to meet the obligations and intent of the Geneva Conventions.

1-5. Allied joint publication (AJP)-2.5 prescribes concepts and procedures for the control and administration of I/R populations by U.S. armed forces operating in Europe under NATO guidelines and outside the European theater in coordination with one or more of the NATO allies. The information in FM 3-39.40 supports AJP-2.5. AJP-2.5 provides—

- Standardized terms and definitions relating to I/R populations.
- Procedures for using DA Form 4237-R (*Detainee Personnel Record*).
- Procedures for handling I/R populations, their personal property, and their money.

1-6. The following objectives of I/R operations pertain to I/R populations:

- Providing humane treatment.
- Evacuating promptly to a safe area.
- Providing opportunities for intelligence exploitation.
- Integrating evacuation, control, and administration procedures.
- Improving subsequent intelligence, evidentiary, and judicial processes.
- Providing critical information to determine each individual's status.
- Increasing accuracy in property accountability to reduce claims against the United States.
- Facilitating final disposition.
- Providing secure detention and efficient care.

PRINCIPLES

1-7. Military police units are specifically organized and trained to perform a variety of missions across the range of I/R operations. While all military police units have an ability to perform I/R operations, those identified as I/R organizations are specifically focused and trained to perform all missions associated with this military police function. Military police are uniquely suited to perform I/R operations because of skills developed via their specific technical training and experience gained through the execution of day-to-day law enforcement missions and the execution of confinement duties at U.S. military corrections facilities. The fundamental principles of these military police missions are directly applicable to the I/R mission. These principles include the following:

- **Humane treatment.** Military police are well trained in the law of land warfare, applicable U.S. laws and regulations, and DOD/Army policies. All detainees (to include U.S. military prisoners) must be protected from unlawful acts of violence and deprivation of basic human necessities must be detained in a safe and secure environment. Humane treatment is consistent with Army and Soldier values and ensures an operational climate that is conducive to population control.

While military police must be fair and firm, humane treatment is essential to establish goodwill among I/R populations and to prevent adversarial relationships between guard forces and I/R populations. (See paragraph 1-29 and appendix D more complete definition of standards for humane treatment.) Standards for humane treatment in this FM are derived from the substantive provisions of the Geneva Conventions that provide for the protection of noncombatants, who deserve to be respected, and deserve to be protected at all times.

- **Close contact.** The very nature of I/R operations places Soldiers in close contact with I/R populations. In one scenario, Soldiers may be in continuous contact or near large displaced populations that contain persons who are tired and hungry, may have lost their families or possessions, and/or are facing an uncertain future. In another scenario, I/R operations may place Soldiers in continuous contact with or near insurgents, terrorists, or criminals who will exploit every opportunity to escape and kill or injure U.S. personnel or multinational partners.
- **Care, custody, and control.** I/R operations require detailed, advanced planning and execution to provide responsive and thorough care, custody, and control of large I/R populations. Military police and other U.S. armed forces must plan, procure, and provide the necessary resources to care for I/R populations, to include subsistence, clothing, hygiene, shelter, and transport to appropriate locations. Military police provide direct supervision and/or control of assisted, detained, or interned persons to ensure their control, health, welfare, and safety. They use their experience and exercise appropriate authority and measured force (using necessary lawful restrictive measures) to mitigate unlawful or inappropriate actions of others, prevent self-harm, and protect persons under their control.
- **Accountability.** U.S. armed forces are accountable for I/R populations, property, evidence, and related documents from the moment of capture until they are released, resettled, repatriated, or transferred to another authority. During I/R operations, Department of Defense (DD) Form 2745 (*Enemy Prisoner of War Capture Tag*) or the subsequent issuance of an internment serial number (ISN) provides the only authorized serial number to be used to track detainees and their property, evidence, and related documents. Accountability must be maintained throughout all activities required for custody; property and evidence control; records management; database management; investigations through legal disposition; and reporting to theater, national, and international organizations (IOs) according to international and U.S. laws, regulations, and policies.
- **Segregation.** I/R populations include numerous types or groups of individuals that must be segregated for a variety of reasons. I/R populations are segregated based on their legal status (according to DOD and Army policies) and their gender. Juveniles within the I/R population are typically segregated from the general population. Detainees may also be segregated by ethnic and family groups and further segregated to protect vulnerable individuals. Additionally, detainees may be categorized by behavior (cooperative, neutral, or combative) to accurately resource guards and facilities. Individuals within the I/R population may also be segregated to prevent self-harm. Although segregation may not be requested or conducted for the purpose of facilitating interrogation, interrogators may interrogate detainees who have been properly segregated. (See DODD 3115.09.)
- **Minimum force.** Military police, guards, and security personnel must use the minimum level of force necessary to protect themselves and others, prevent escapes, or prevent persons from self-harm. I/R facility commanders carefully balance using applied force when an unlawful activity or civil disturbance occurs, violence escalates, or an escape attempt occurs. Military police, guards, and security personnel must apply a measured response when confronting violent and/or noncompliant I/R populations. Minimum force also applies when using restraints. Individuals who pose an imminent escape risk or are identified as a potential threat to themselves or others may need to be restrained to prevent them from escaping or committing acts of violence. The level of restraint required varies with each situation. In the most severe circumstances, restraining individuals may involve applying restraints to fully immobilize them. In less severe circumstances, restraining an individual may involve using verbal commands, such as "Halt." Restraints should only be applied to mitigate actual risks. Restraining for any other

purpose may be counterproductive to effective I/R operations and may not be in compliance with international laws.

WARNING

At no time should restraints be used as punishment.

PERSONNEL CATEGORIES

1-8. Key personnel category terms are defined in the following paragraphs. These terms include detainees and their subcategories, U.S. military prisoners, and DCs and their subcategories. For the purposes of this manual, I/R populations refer to detainees, U.S. military prisoners, and DCs.

DETAINEES

1-9. *Detainee* is a term used to refer to any person captured or otherwise detained by an armed force. (JP 3-63) Detainees may also include enemy combatants (EPWs and members of armed groups), RP, and CIs. (See DODD 2310.01E.) Detainees do not include personnel being held for law enforcement purposes, except where the U.S. is the occupying power.

Civilian Internees

1-10. A *CI* is a civilian who is interned during armed conflict, occupation, or other military operation for security reasons, for protection, or because he or she committed an offense against the detaining power. (JP 3-63) CIs, unless they have committed acts for which they are considered unlawful combatants, generally qualify for protected status according to the GC, which also establishes procedures that must be observed when depriving such civilians of their liberty. CIs are to be accommodated separately from EPWs and persons deprived of liberty for any other reason.

1-11. *Protected persons* are persons protected by the Geneva Convention who find themselves, in case of a conflict or occupation, in the hands of a party to the conflict or occupying power of which they are not nationals. (AR 190-8). Protected persons who are interned for imperative reasons of security are also known as CIs. Protected persons under the Geneva Conventions include—

- Hors de combat (refers to the prohibition of attacking enemy personnel who are “out of combat”).
- Detainees (combatants and CIs).
- Wounded and sick in the field and at sea.
- Civilians.

Note. If protected persons are detained as spies or saboteurs or are suspected of or engaged in activities hostile to the security of the state or occupying power, they may be interned or imprisoned. In such cases, they retain their status as a protected person and are granted the full rights and privileges of protected persons.

Retained Personnel

1-12. *RP* are enemy medical personnel and medical staff administrators who are engaged in the search for, collection, transport, or treatment of the wounded or sick, or the prevention of disease; chaplains attached to enemy armed forces; and staff of National Red Cross Societies and that of other volunteer aid societies, duly recognized and authorized by their governments to assist medical service personnel of their own armed forces, provided they are exclusively engaged in the search for, or the collection, transport or treatment of wounded or sick, or in the prevention of disease, and provided that the staff of such societies are subject to military laws and regulations. (JP 3-63)

1-13. RP is a special category for medical personnel and chaplains because of their special skills and training. These individuals may be retained by the detaining power to aid other detainees, preferably those of the armed forces to which they belong. (See FM 27-10.) The Geneva Conventions require that RP receive, at a minimum, the benefits and protection given to those with EPW status. The Geneva Conventions require that they be granted the facilities necessary to provide medical care and religious ministry services to the I/R population. (For a complete discussion on RP, see AR 190-8.)

1-14. Privileges and considerations extended to RP because of their profession include—

- Additional correspondence privileges for chaplains and senior retained medical personnel.
- All facilities necessary to provide detainees with medical care, spiritual assistance, and welfare services.
- Authority and means of transportation for periodic visits to other I/R facilities and to hospitals outside the RP I/R facility to carry out their medical, spiritual, or welfare duties.
- Restriction of work assignments to only those medical or religious duties that they are qualified to perform.
- Assignment to quarters separate from those of other detainees when possible.

Enemy Combatants

1-15. An *enemy combatant* is, in general, a person engaged in hostilities against the United States or its coalition partners during an armed conflict. (JP 3-63) Enemy combatant includes EPWs and members of armed groups.

1-16. Enemy combatants are divided as follows:

- **An *enemy prisoner of war* is a detained person who, while engaged in combat under orders of his or her government, was captured by the armed forces of the enemy.**
- **Member of an armed group is a person who engages in or supports acts against the United States or its multinational partners in violation of the laws and customs of war during an armed conflict that do not meet the criteria of a prisoner of war as defined within the Geneva Convention Relative to the Treatment of Prisoners of War.** Members of armed groups are not entitled to combatant immunity and will be treated as CIs until, or unless, otherwise directed by competent authorities.

1-17. EPWs are persons defined in the GPW as—

- Members of the armed forces of a party to the conflict and members of militias or volunteer corps forming part of such armed forces.
- Members of other militias and members of other volunteer corps, including those of organized resistance movements, belonging to a party to the conflict and operating in or outside their own territory, even if this territory is occupied, provided that such militias or volunteer corps, including such organized resistance movements, fulfill the following conditions:
 - That of being commanded by a person responsible for his or her subordinates.
 - That of having a fixed distinctive sign recognizable at a distance.
 - That of carrying arms openly.
 - That of conducting their operations according to the laws and customs of war.
- Members of regular armed forces who profess allegiance to a government or an authority not recognized by the detaining power.
- Persons who accompany the armed forces without actually being members thereof, such as civilian members of military aircraft crews, war correspondents, supply contractors, members of labor units or of services responsible for the welfare of the armed forces, provided that they have received authorization from the armed forces which they accompany, who will provide them for that purpose with an identity card similar to the annexed model.
- Members of crews, including masters, pilots and apprentices, of the merchant marine and the crews of civil aircraft of the parties to the conflict, who do not benefit by more favorable treatment under any other provisions of international laws.

- Inhabitants of a unoccupied territory, who on the approach of the enemy spontaneously take up arms to resist the invading forces, without having had time to form themselves into regular armed units, provided they carry arms openly and respect the laws and customs of war.

Note. EPW status is the default status for detainees. All detainees will be treated according to the GPW until their status is determined by a military tribunal or other competent authority. The United States uses the term *EPW* to identify an individual under the custody and/or control of the DOD according to Articles 4 and 5 of the GPW. (See JP 3-63.) The United States reserves the GPW term *prisoner of war* to identify its own or multinational armed forces that have been taken captive.

U.S. MILITARY PRISONERS

1-18. A *U.S. military prisoner* is a person sentenced to confinement or death during a court-martial and ordered into confinement by a competent authority, whether or not the convening authority has approved the sentence. A U.S. military prisoner who is pending trial by court-martial and is placed into confinement by a competent authority is a pretrial prisoner. (See chapter 7.)

DISLOCATED CIVILIANS

1-19. The term *dislocated civilian* is a broad term that includes a displaced person, an evacuee, an expellee, an internally displaced person, a migrant, a refugee, or a stateless person. (JP 3-57) DCs are individuals who leave their homes for various reasons, such as an armed conflict or a natural disaster, and whose movement and physical presence can hinder military operations. They most likely require some degree of aid, such as medicine, food, shelter, or clothing. DCs may not be native to the area or to the country in which they reside. (See chapter 10.) The following DC subcategories are also defined in JP 3-57:

- **Displaced person.** A *displaced person* is a civilian who is involuntarily outside the national boundaries of his or her country. (JP 1-02) Displaced persons may have been dislocated because of a political, geographical, environmental, or threat situation.
- **Evacuee.** An *evacuee* is a civilian removed from a place of residence by military direction for reasons of personal security or the requirements of the military situation. (JP 3-57)
- **Expellee.** An *expellee* is a civilian outside the boundaries of the country of his or her nationality or ethnic origin who is being forcibly repatriated to that country or to a third country for political or other purposes. (JP 3-57)
- **Internally displaced person.** An *internally displaced person* is any person who has left their residence by reason of real or imagined danger but has not left the territory of their own country. Internally displaced persons may have been forced to flee their homes for the same reasons as refugees, but have not crossed an internationally recognized border.
- **Migrant.** A *migrant* is a person who (1) belongs to a normally migratory culture who may cross national boundaries, or (2) has fled his or her native country for economic reasons rather than fear of political or ethnic persecution. (JP 3-57)
- **Refugee.** A *refugee* is a person, who by reason of real or imagined danger, has left their home country or country of their nationality and is unwilling or unable to return.
- **Stateless person.** A *stateless person* is a civilian who has been denationalized or whose country of origin cannot be determined or who cannot establish a right to the nationality claimed.

STATUS DETERMINATION

1-20. If there is any doubt whether personnel captured or detained by the U.S. armed forces belong to any of the detainee categories previously described in paragraph 1-17, and Article 4, GPW, such personnel receive the same treatment to which EPWs are entitled until their status has been determined by a competent military tribunal or some other competent authority. (See AR 190-8.) Captured or detained personnel are presumed to be EPWs immediately upon capture if their status is unmistakable (such as an

armed, uniformed enemy). The final status of a CI may not be determined until they arrive at a TIF. Until such time, treat all CIs as EPWs.

Note. It is essential to understand the distinction between the terms *treatment* and *status*. To treat a detainee as an EPW does not mean that the detainee has the actual status of an EPW as set forth in the Geneva Conventions.

ARTICLE 5 TRIBUNALS

1-21. Article 5 tribunals are conducted according to Article 5, GPW. An Article 5 tribunal is an administrative hearing that is controlled by a board of officers and determines the actual status of a detainee. This tribunal can take place anywhere, but it most commonly takes place echelons above the brigade combat team (BCT), most generally at the TIF or SIF. The tribunal determines the status of individuals who do not appear to be entitled to prisoner of war status, but have committed a belligerent act or have engaged in hostile activity to aid enemy forces and/or assert that they are entitled to treatment as an EPW.

Note. Sample procedures with additional (optional) procedures for conducting an Article 5 tribunal are included in appendix D. Optional procedures are intended to add appropriate due process measures that are not required by laws or regulations, but improve the transparency and overall fairness of the tribunal as time and additional resources are available to the convening authority. The tribunal is an administrative board process and is not intended to become an adversarial process.

1-22. EPWs have GPW protections from the time they are under the control of U.S. armed forces until their release or repatriation. Any detainee subject to an Article 5 tribunal will be provided and entitled to a—

- Notice of the tribunal (in a language he or she understands).
- Opportunity to present evidence at the tribunal.
- Three-person administrative tribunal.
- Preponderance of the evidence standard.
- Written appeal to the convening authority upon request.

1-23. The convening authority of the Article 5 tribunal will be a commander exercising general court-martial convening authority, unless such authority has been properly delegated. According to AR 190-8 and DOD policies, a competent tribunal will—

- Convene within a reasonable time after doubt arises regarding EPW status, normally within 15 days. Processing time for the tribunal procedures should not normally exceed 30 days. Shorter processing times are encouraged, particularly when there is a potential for a status change from EPW to CI or a members of an armed group.
- Determine the status of any individual who does not appear to be entitled to EPW status, but has committed a belligerent act or has engaged in hostile activities to aid enemy armed forces and asserts that he or she is entitled to treatment as an EPW.
- Be composed of three commissioned officers (one a field grade). The senior officer will serve as president of the tribunal and another nonvoting officer (preferably a judge advocate) will serve as the recorder.

Note. A separate system of combatant status review boards have been adopted by laws and regulations to review the status of members of armed groups designated under approved DOD procedures. Recent executive decisions may provide further directives regarding the processing and disposition of this category of personnel. Detainees who have been determined by a competent tribunal not to be entitled to EPW status will not be executed, imprisoned, or otherwise penalized without further proceedings to determine what acts they have committed and what penalty should be imposed. Commanders should notify the combatant command if a U.S. citizen or resident alien has been captured or has requested a tribunal.

APPEALS AND PERIODIC REVIEWS OF CIVILIAN INTERNEES

1-24. CIs may be interned or placed in assigned residences only when the security of the detaining power makes it absolutely necessary or there are imperative reasons of security of the occupying power. (See GC, Articles 27, 42, and 78.) The internment of civilians is a serious deprivation of liberty for the civilian population. Accordingly, each CI—

- Is released by the detaining power as soon as the reasons which necessitated his internment no longer exist (Article 132, GC).
- Receives an order of internment (in a language the CI understands) as directed in AR 190-8. This order must be provided without delay, usually within 72 hours of capture/internment.
- Receives notice (in a language the CI understands) of the right to appeal the internment or placement in an assigned residence.
- Has the right to appeal the internment or placement in an assigned residence. This appeal should receive proper consideration and a decision should be rendered as soon as possible by an appropriate administrative tribunal.

1-25. The convening authority of the administrative tribunal will be a commander exercising general court-martial convening authority, unless such authority has been properly delegated. A competent CI review tribunal will—

- Convene within a reasonable time after the appeal is requested (normally within 72 hours). Processing time for the tribunal procedures will not normally exceed 14 days. Shorter processing times are encouraged, particularly when there is a potential for a status change from CI to member of an armed group or common criminal.
- Is composed of three commissioned officers (a field grade). The senior officer will serve as president of the tribunal. Another nonvoting officer (preferably a judge advocate) will serve as the recorder.

1-26. Any detainee being subject to a CI review tribunal will be provided and entitled to a—

- Notice of the tribunal (in a language he or she understands).
- Opportunity to present evidence at the tribunal.
- Three-person administrative tribunal.
- Preponderance of the evidence standard.
- Written appeal to the convening authority upon request.

1-27. In the event that the decision of internment or placement is upheld, the tribunal has an affirmative duty (at least every 6 months) to periodically review the lawfulness of the internment or placement. Recognizing the gravity of continued internment as a deprivation of liberty of the civilian population, convening authorities are encouraged to incorporate more due process into the procedures for all periodic review proceedings. Detainees who have been determined by a CI review tribunal not to be entitled to release from internment or placement in an assigned residence will not be executed, imprisoned, or otherwise penalized without further judicial proceedings to determine what acts they have committed and what penalty should be imposed.

Note. The preceding procedures are the minimum standards for conducting a CI review tribunal as resources and time permit. For subsequent reviews, the convening authority may adopt additional procedures for these tribunals.

GENERAL PROTECTION AND CARE OF DETAINEES, U.S. MILITARY PRISONERS, AND DISLOCATED CIVILIANS

1-28. DOD personnel conducting I/R operations will always treat detainees, U.S. military prisoners, and DCs under their custody or care humanely, no matter what their individual status is under U.S. or international laws and no matter how the conflict or crisis is characterized. The Geneva Conventions provide internationally recognized humanitarian standards for the treatment of detainees. (See appendix D.) U.S. military prisoners confined in a battlefield environment are also entitled to the constitutional protections afforded to every citizen of the United States. Some DCs may be refugees covered by the Convention Relating to the Status of Refugees, which establishes minimum standards for the treatment of refugees and specifies the obligations of the HN and the refugees.

HUMANE TREATMENT POLICIES

1-29. DODD 2310.01E establishes overarching DOD detainee policies, including detainee treatment policies. DODD 2310.01E applies to all detainee operations conducted during armed conflicts, however such conflicts are characterized in all other military operations. The policies are applicable to—

- DOD personnel (civilian and military).
- DOD contractors assigned to or supporting the DOD components engaging in, conducting, participating in, or supporting detainee operations.
- Non-DOD personnel as a condition of permitting access to internment facilities or to detainees under DOD control.

1-30. The humane treatment of detainees by U.S. personnel is paramount to successful operations and an absolute moral and legal requirement. All DOD personnel will comply with the law of war at all times. Personnel conducting detainee operations will apply at a minimum and without regard to a detainee's legal status, the standards articulated in Common Article 3 to the Geneva Conventions. Any persons detained will be afforded the protections of Common Article 3 to the Geneva Conventions from the moment they are under the control of DOD personnel until their release, transfer, or repatriation.

Note. Certain categories of detainees, such as EPWs, enjoy protections under the law of war in addition to the minimum standards prescribed in Common Article 3 to the Geneva Conventions.

DETAINEE TREATMENT POLICIES

1-31. In addition to the standards required under the Geneva Conventions and the law of war, the following minimum standards for detainee treatment are required by DODD 2310.01E:

- Detainees will be provided adequate food, drinking water, shelter, clothing, and medical treatment. Detainees will be provided the same standard of health care as U.S. forces in the geographical area.
- Detainees will be granted free exercise of religion that is consistent with the requirements of detention.
- Detainees will be respected as human beings. They will be protected against threats or acts of violence, including rape, forced prostitution, assault, theft, public curiosity, bodily injury, and reprisals. They will not be subjected to medical or scientific experiments. Detainees will not be subjected to sensory deprivation. This list is not all-inclusive.

- The punishment of detainees known to have, or suspected of having, committed serious offenses will be administered according to due process of law and under legally constituted authority.
- The inhumane treatment of detainees is prohibited and is not justified by the stress of combat or deep provocation.

U.S. MILITARY PRISONER POLICIES

1-32. The same standards of humane treatment apply to the battlefield confinement of U.S. military prisoners as apply to other I/R operations. In addition, U.S. military prisoners have specific constitutional rights and protections afforded by their status as U.S. persons. As Soldiers, they enjoy rights and protections under the UCMJ and the Manual for Courts-Martial (MCM). U.S. military prisoners will not be interned with detainees or DCs. (See chapter 7 and AR 190-47.)

DISLOCATED CIVILIAN POLICIES

1-33. DCs who have moved in response to a natural or man-made disaster have the following in common:

- They are unable or unwilling to stay in their homes.
- Their physical presence can affect military operations.
- They require some degree of aid, to include many of the basic human necessities.

1-34. DCs are to be provided humane care and treatment consistent with the Geneva Conventions and international laws, regardless of the categorization given to them by higher authority.

1-35. Some DCs may be refugees covered by the Convention Relating to the Status of Refugees and Article 73, Geneva Protocol I (wherein stateless persons or refugees are protected persons within the meaning of Part I and Part III, GC). The Convention Relating to the Status of Refugees provides a general and universally applicable definition of the term *refugee* and establishes minimum standards for the treatment and protection of refugees, specifying the obligations of the HN and the refugees to one another. Among the important provisions of this convention is the principle of nonrefoulement (Article 33), which prohibits the return or expulsion of a refugee to the territory of a state where his life, freedom, or personal security would be in jeopardy. I/R personnel conducting DC operations that involve refugees will not repatriate refugees until directed by applicable governmental organizations through the chain of command.

1-36. Refugees have the right to safe asylum and basic civil, economic, and social rights. For example, adult refugees should have the right to work and refugee children should be able to attend school. In certain circumstances (such as large-scale inflows of refugees), asylum states may feel obliged to restrict certain rights. The UN High Commissioner for Refugees assists to fill gaps when no resources are available from the government of the country of asylum or other agencies. (See the UN High Commissioner for Refugees Handbook for the Military on Humanitarian Operations.) When possible, units conducting I/R operations involving refugees should establish provisions for the protection of these rights that are consistent with military necessity and available resources.

ABUSE OR MISTREATMENT

1-37. All DOD personnel (military, civilian, and contractor) must correct, report, and document any incident or situation that might constitute the mistreatment or abuse of detainees, U.S. military prisoners, or DCs. Acts and omissions that constitute inhumane treatment may be violations of U.S. laws, U.S. policies, and the law of war. These violations require immediate action to correct. If a violation is ongoing, Soldiers have an obligation to take action to stop the violation and report it to their chain of command.

1-38. All personnel who observe or have knowledge of possible abuse or mistreatment will immediately report the incident through their chain of command or supervision. Reports may also be submitted to the military police, a judge advocate, a chaplain, or an inspector general, who will then forward the report through the recipient's chain of command or supervision. Reports made to other officials will be accepted and immediately forwarded through the recipient's chain of command or supervision, and an information copy will be provided to the appropriate combatant commander.

1-39. Any commander or supervisor who obtains credible information about actual or possible abuse or mistreatment involving personnel who are not assigned to a combatant commander will immediately report the incident through command or supervisory channels to the responsible combatant commander or to another appropriate authority (criminal investigation division [CID], inspector general) for allegations. In the latter instance, an information report is sent to the combatant commander with responsibility for the geographic area where the alleged incident occurred.

AGENCIES CONCERNED WITH INTERNMENT AND RESETTLEMENT

1-40. External involvement in I/R missions is a fact of life for military police organizations. Some government and government-sponsored entities that may be involved in I/R missions include—

- International agencies.
 - UN.
 - International Committee of the Red Cross (ICRC).
 - International Organization of Migration.
- U.S. agencies.
 - Local U.S. embassy.
 - Department of Homeland Security.
 - U.S. Immigration and Customs Enforcement (ICE).
 - Federal Emergency Management Agency.

1-41. The U.S. Army National Detainee Reporting Center (NDRC), supported by theater detainee reporting centers (TDRCs), detainee accountability, including reporting to the ICRC central tracing agency.

1-42. There are also numerous private relief organizations, foreign and domestic, that will likely be involved in the humanitarian aspects of I/R operations. Likewise, the news media normally provides extensive coverage of I/R operations. Adding to the complexity of these operations is the fact that DOD is often not the lead agency. For instance, the DOD could be tasked in a supporting role, with the Department of State or some other agency in the lead. (See appendix E.)

CIVILIAN ORGANIZATIONS

1-43. The most effective way for U.S. armed forces to understand the skills, knowledge, and capabilities of nonmilitary organizations is through the Military Education System and through the establishment and/or maintenance of a liaison once deployed to the operational area. In addition, having those organizations provide briefings on their capabilities and limitations to each other and to the military is an effective method to gain understanding on both sides to support the mission.

1-44. Civilian organizations are responsible for a wide range of activities encompassing humanitarian aid; human rights; the protection of minorities, refugees, and displaced persons; legal assistance; medical care; reconstruction of the local infrastructure; agriculture; education; and general project funding. It is critical importance that commanders and their staffs understand the mandate, role, structure, method, and principles of these organizations. It is impossible to establish an effective relationship with them without this understanding.

1-45. Civilian organizations may already be providing humanitarian-assistance or some type of relief in the operational area when I/R operations are planned and implemented. (See appendix E.) The principal coordinating federal agency is the U.S. Agency for International Development. Civilian organizations are required to register with the U.S. Agency for International Development to operate under the auspices of the United States.

1-46. A detailed description of nonmilitary U.S. government agencies typically involved in I/R operations is contained in appendix E. The non-U.S. government organizations most likely to be encountered during I/R operations are international humanitarian organizations. These are impartial, neutral, and independent

organizations whose mission is to assist and protect victims of conflict. This group includes organizations such as the ICRC, the International Federation of the Red Cross (IFRC), and the Red Crescent Societies. They carefully guard their neutrality and do not desire to be associated with or dependent on the military for fear of losing their special status in the international community that allows them to fulfill their mission. The two principal types of non-U.S. government civilian organizations are—

- **IOs.** IOs are established by international agreements and operate at the nation-to-nation level. IOs include the UN, the UN Development Program, the UN Office for the Coordination of Humanitarian Affairs, the UN World Food Program, and the International Medical Corps. The UN High Commissioner for Refugees is a key player in international detainee operations.
- **Nongovernmental organizations (NGOs).** NGOs are voluntary organizations that are not normally funded by governments. They are primarily nonprofit organizations that self-define their missions and philosophies. This independence from political interests is the key attribute of NGOs and can be a great benefit in rebuilding relations when political dialog has failed or is not practicable. They are often highly professional in their field, extremely well motivated, and prepared to take physical risks in appalling conditions. Examples of NGOs include Save the Children, Medecins Sans Frontières (Doctors without Borders), Catholic Relief Services, and Catholic Bishops Council. NGOs are classified as mandated or nonmandated as described below:
 - A mandated NGO has been officially recognized by the lead IO in a crisis and is authorized to work in the affected area. The ICRC is an example of a mandated NGO.
 - A nonmandated NGO has no official recognition or authorization and, therefore, works as a private concern. These organizations may be subcontracted by an IO or mandated NGO. In other cases, they obtain funds from private enterprises and donors. Catholic Relief Services is an example of a nonmandated NGO.

UNITED NATIONS

1-47. The UN is involved in the entire spectrum of humanitarian-assistance operations, from suffering prevention to relief operations. Typically, UN relief agencies establish independent networks to execute their humanitarian-relief operations. The UN system delegates as much as possible to the agency's elements located in the field; supervisory and support networks are traced from those field officers back to UN headquarters. Military planners must familiarize themselves with UN objectives so that these objectives are considered in planning and executing military operations. (See appendix E.)

PROTECTING POWER

1-48. The primary power duty of the protecting power is to monitor whether detainees are receiving humane treatment as required by international laws. A neutral state or a humanitarian organization, such as the ICRC, is usually designated as a protecting power. Representatives or delegates of a protecting power are authorized to visit detainees and interview them regarding the conditions of their detention, their welfare, and their rights. Depending on the circumstances, they may conduct interviews without witnesses. Such visits may not be prohibited except for reasons of imperative military necessity.

INTERNATIONAL RED CROSS AND RED CRESCENT MOVEMENT

1-49. The ICRC, IFRC, and individual national Red Cross and Red Crescent organizations make up the International Red Cross and Red Crescent Movement. These groups are distinctly different and have separate mandates and staff organizations. They should not be considered to be one organization. Although the ICRC was founded in Switzerland, it has a long and distinguished history of worldwide operation as a neutral intermediary in armed conflicts. The mission of the ICRC is to ensure that victims of conflict receive appropriate protection and assistance within the scope of the Geneva Conventions and Geneva Protocol II.

Note. The Red Crescent Movement is found in predominately Muslim countries and has the same goals and mission as the Red Cross Movement.

CIVILIAN LEAD AGENCIES

1-50. A civilian lead agency is an agency that has been designated by the appropriate IO to coordinate the activities of the civilian organizations that participate in an operation. It is normally a major UN agency such as the UN Office for the Coordination of Humanitarian Affairs. Specific responsibilities of the lead agency include acting as a point of contact for other agencies and coordinating field activities to avoid duplication of effort.

PLANNING CONSIDERATIONS FOR INTERNMENT AND RESETTLEMENT OPERATIONS

1-51. Proper planning before operations commence is vital. It is also essential that commanders recognize that conditions for the proper conduct of I/R operations are historically set in the planning phase of operations. Commanders should establish planning mechanisms that ensure effective consideration of potential detainee, U.S. military prisoner, or DC issues and the development of plans and procedures to respond to these issues as early in the planning process as feasible. Commanders should, address at a minimum—

- **Infrastructure requirements.** The commander should analyze the wide array of sustainment and operational requirements to conduct I/R operations. These requirements begin with the correct number and type of personnel on the ground to conduct the operation and the identification, collection, and the management of a sustainment plan to support I/R operations throughout the joint operations area.
- **Security requirements.** To the maximum extent possible, I/R facilities will be protected from the hazards of the battlefield. To protect the I/R population, commanders—
 - Manage the control of captured protective equipment that could be used to meet requirements.
 - Ensure that when planning for individual protective measures and facility protection, the potential presence of detainees is considered. As a general rule, detainees should derive the same benefit from protection measures as do members of the detaining force.
- **Use-of-force training.** Planning and preparing for the use of force is a necessary element in maintaining order. Personnel assigned the mission of providing for the control of detainees, U.S. military prisoners, and DCs and the security of I/R facilities should be issued and trained on RUF that are specific to that mission. Theater rules of engagement (ROE) remain in effect for defending an I/R facility from an external threat.
- **Safety and evacuation plans.** When controlling large I/R populations, commanders must develop thorough safety and evacuation plans to evacuate, shelter, protect, and guard (as appropriate) U.S. armed forces personnel and I/R populations from fire, combat hazards, natural elements, and nonbattle injuries. Safety plans must be incorporated into I/R facility standing operating procedures (SOPs) and refined through continuous risk assessments and mitigation. Commanders must ensure that safety and evacuation plans are routinely trained and rehearsed.
- **Medical and dental care.** I/R facility commanders must consider a wide range of topics when planning for medical support, to include a credentialed health care provider to monitor the general health, nutrition, and cleanliness of detainees, U.S. military prisoners, and DCs (appendix I). The medical facility must provide isolation wards for persons with communicable diseases and for immunizations. Special consideration may be necessary for behavioral and dental health support. The Geneva Conventions provide extensive guidance on medical and dental standards of care for wounded and sick EPWs and CIs.
- **Sanitation requirements.** Certain sanitation standards must be met to protect the health of all detainees, U.S. military prisoners, DCs, and U.S. armed forces associated with the facility (such as disease prevention and facility cleanliness). (See appendix J.) These standards include providing adequate space within housing units to prevent overcrowding, enforcing food sanitation procedures, properly disposing of human waste, and conducting pest control activities as required. The Geneva Conventions provide extensive guidance on sanitation requirements for EPWs and CIs.

- **Intelligence and interrogation operations.** The U.S. armed forces operating the I/R facility need to plan for human intelligence (HUMINT) collection operations, which require close cooperation with HUMINT collectors and counterintelligence agents. Further consideration must be given to ensure that interrogation operations in the facility are conducted according to applicable U.S. laws and regulations, international laws, operation orders, FRAGOs, and other operationally specific guidelines (DOD policies). The internment facility commander is responsible for ensuring proper care and treatment for detainees. (For a detailed discussion of responsibilities and support relationships dictated by DOD policies and for more information on HUMINT operations see FM 2-22.3.)
- **Strategic reporting.** Strategic reporting of detainees and DCs requires adherence to the Detainee Reporting System (formerly known as the Branch Prisoner of War Information System) procedures. The timely and accurate reporting of data is critical to ensuring detainee and DC accountability and compliance with U.S. and international laws. I/R operations are monitored at the strategic level. Overwatch and strategic accountability of detainees and DCs are exercised by the Office of the Provost Marshal General (OPMG), NDRC Branch. The basic element of detainee and DC accountability is the ISN, which is used as the primary means of identification. ISNs are issued at the TIF. They are also used to link detainees and DCs to biometric data, deoxyribonucleic acid (DNA) data, personal property, medical information, and issued equipment. Military police commanders conducting detainee operations must plan for the acquisition and issuance of ISNs and maintenance of the Detainee Reporting System, to include training military police personnel.
- **Legal support.** I/R operations must comply with the law of war during armed conflicts. Proper legal support must be considered to ensure that U.S. policies, U.S. laws, and international laws are observed. Actively involving judge advocate general personnel and expertise at all stages and in all types of I/R operations is essential. All personnel, regardless of military occupational specialty (MOS) or branch specialty, must receive I/R training and instruction, relevant to their role in advance of participating in or supporting detainee operations; I/R-specific training should be conducted annually thereafter. Training requirements and completion is documented according to applicable laws and policies. Personnel must receive instruction and complete training commensurate with their duties, regarding the—
 - Geneva Conventions and laws, regulations, policies, and other issuances applicable to detainee operations.
 - Identification and prevention of violations of the Geneva Conventions.
 - Requirement to report alleged or suspected violations that arise in the course of detainee operations.
- **Liaison with external agencies.** During the course of I/R operations, it is likely that U.S. commanders will encounter representatives of various government agencies, IOs, NGOs, and international humanitarian organizations attempting to assert a role in protecting the interests of detainees, U.S. military prisoners, or DCs. Commanders must anticipate that these organizations will request access to I/R populations and will continue to do so throughout the operation. The ICRC will be given the opportunity to provide its services to detainees (to include detainees at TIFs). The servicing staff judge advocate is generally the designated command liaison to the ICRC. (See FM 27-10.) ICRC reports provided to U.S. commanders will be forwarded through combatant commander channels.
- **Transportation requirements.** The modes of transportation for movement of detainees, U.S. military prisoners, and DCs are by foot, wheeled vehicle (preferably bus or truck), rail, air, inland waterways and sea. Each operation requires unique security and accountability planning which must closely adhered to and carefully planned. The flow of personnel must be coordinated with movement control personnel as appropriate. (The movement of detainees is discussed in chapter 4.)
- **Public affairs.** Public affairs planning requires an understanding of the information needs of Soldiers, the Army community, and the public in matters relating to I/R operations. In the interest of national security and the protection of I/R populations from public curiosity, I/R populations will not be photographed or interviewed by the news media. The public affairs

officer also facilitates media efforts to cover operations by expediting the flow of complete, accurate, and timely information.

- **Transfers and transitions.** The successful end state of I/R operations is the final disposition of detainees, U.S. military prisoners, and DCs. This may include their transfer, release, resettlement, or continued detention. The permanent transfer or release of detainees from the custody of U.S. armed forces to the HN, other multinational forces, or any non-DOD U.S. government entity requires the approval of the Secretary of Defense or a specified designee. The permanent transfer of a detainee or DC to a foreign nation may be governed by bilateral agreements or based on ad hoc arrangements. Any transfer to the HN or a foreign nation will include assurances that the receiving nation is willing and able to provide adequate care and treatment that is required by the Geneva Conventions.

1-52. The preceding planning considerations are not all-inclusive. Thorough mission analysis is critical to determine requirements and establish adequate training plans to ensure success. I/R planning factors are covered in depth in chapter 5.

MILITARY POLICE CAPABILITIES

1-53. Military police personnel (MOSs 31B and 31E) provide indispensable capabilities required for conducting of I/R operations. Military police Soldiers hone their skills through I/R-specific training and complementary training and experience gained in performance of the other four military police functions. Of the four remaining military police functions, police intelligence operations and law and order operations provide the greatest complementary technical and tactical capabilities to enhance I/R operations. All military police personnel receive I/R-specific training and instruction in advance of participating in or supporting detainee operations and received annually thereafter. Training requirements and completion are documented according to applicable laws and policies. All military police personnel receive instruction and complete training equal to their duties regarding the—

- Geneva Conventions and all laws, regulations, policies, and other issuances applicable to detainee operations.
- Identification and prevention of violations of the Geneva Conventions.
- Requirement to report alleged or suspected violations that arise in the course of detainee operations.

1-54. When performing I/R operations, 31B personnel bring a variety of skill sets, inculcated through their training. These skills include—

- Interpersonal communications.
- Use-of-force guidelines and standards.
- Civil disturbance operations.
- Use of NLWs in any environment.
- Custody, control, and audit maintenance requirements for I/R operations.
- Police investigations.
- Cultural awareness.

1-55. Military police personnel within the 31E MOS are specifically trained to conduct I/R operations across the full range of potential environments. They provide technical capabilities specific to I/R, making them the subject matter experts in full-scale I/R operations. These skills include—

- Interaction and use of U.S., third world country, and local national interpreters during I/R operations.
- I/R facility operations (cell blocks, recreation areas, shower areas, latrines, mess areas).
- Safe and proper take-down techniques to ensure the well-being of all personnel involved.
- Proper and effective movement techniques when moving an individual from one location to another.
- Use of NLWs in any environment.
- Cultural awareness.

Internment and Resettlement Operations and the Operational Environment

- Riot control measures, to include the use of riot control agents and dispersers.
- Quick-reaction force actions inside and outside the facility.
- Search techniques, to include the use of electronic detection devices.
- Detainee treatment standards and applicable provisions of the law of war.
- Current, approved interrogation techniques.

This page intentionally left blank.

Chapter 2

Internment and Resettlement in Support of the Spectrum of Operations

I/R operations are of significant importance at all levels of war and across the spectrum of conflict. They are typically tactical operations that may have strategic impact. Soldiers conducting I/R operations must be professional and compassionate. The failure to maintain professional and humane behavior will have far-reaching impacts. Although military police units (to include military police platoons within a BCT) are typically the first military police elements performing I/R operations, modular I/R battalions with assigned I/R detachments, I/R companies, guard companies, and supporting military working dog (MWD) teams are equipped and trained to handle long-term I/R operations.

Note. While many Soldiers come in contact with detainees, only those trained and certified to handle detainees (according to Army policies) should be placed in positions where detainees are in their custodial care.

2-1. The I/R function includes missions involving the movement and protection of DCs and operations to secure and protect detainees from the POC through the TIF or SIF. These operations may be within a contiguous or noncontiguous AO. In either framework, military police take control of detainees, typically at the DCP and expedite movement from the POC through the DHA to the TIF or SIF to ensure the freedom of maneuver for maneuver units and the safe and humane treatment of detainees under U.S. control. During combat operations involving DCs, military police control movement to avoid the disruption of combat forces and to protect DCs from avoidable hazards. In all environments involving DCs, military police may be required to support the movement of personnel and temporary resettlement facilities to ensure the safety and security of persons displaced due to natural or man-made disasters or conditions. Additionally, I/R units may be conducting day-to-day custody and control operations simultaneously for the confinement of U.S. military prisoners at permanent sites around the world and tactical I/R operations in support of a DHA, TIF, or SIF.

SUPPORT TO COMBAT OPERATIONS

2-2. The Army is the DOD executive agent for detainee operations. Additionally, the Army is the DOD executive agent for the long-term confinement of U.S. military prisoners. Within the Army and through the geographic combatant commander, military police units are tasked with coordinating shelter, protection, accountability, and sustainment for detainees; that role is primarily being performed by I/R units, but is supported by other military police units as necessary.

2-3. The I/R function serves a significant humane and tactical importance. In any conflict involving U.S. forces, the safe and humane treatment of detainees is required by international laws. Military actions across the spectrum of operations will likely result in detainees. In major combat operations, entire units of enemy forces, separated and disorganized by the shock of intensive combat, may be captured. The magnitude of such numbers places a tremendous burden on operational forces as they divert tactical units to handle these detainees. Similarly, large numbers of CIs may also be interned during long-term stability operations, and DCs may place an additional load on the operational commander. Military police units performing the I/R function can preserve the capturing combat effectiveness of the unit by removing these detainees or DCs as rapidly and safely as possible in conjunction with initial interrogation requirements and other operational considerations. Military police units support the force by relieving tactical commanders of the requirement

to divert large numbers of combat forces to handle detainees and removing DCs from routes and locations that would have an adverse effect on operations. Military police units perform the I/R functions of collecting, evacuating, and securing detainees and DCs throughout the AO. In this process, military police and military intelligence (MI) units coordinate closely. It is essential that military police and MI Soldiers have a high level of situational awareness and share information with each other.

2-4. The organic military police platoon in the BCT is ideally positioned to take control of detainees from the combat force in the BCT AO. Although the BCT military police platoon initially handles detainees, modular I/R battalions with assigned guard companies and supporting MWD teams are equipped and trained to handle this mission for the long term. An I/R battalion is typically organized to support, safeguard, account for, guard, and provide humane treatment for up to 4,000 EPWs/CIs, 8,000 DCs, or 1,500 U.S. military prisoners; however, certain missions may require additional resources and manning (for example, long-term counterinsurgency internment).

2-5. The commander, detainee operations (CDO), is typically responsible for detention facility and interrogation operations in the joint operations area. The CDO should have detainee operations experience and will normally be the senior military police commander. If the size and scope of the detainee operation warrants, the joint force commander may consider designating a general or flag officer as the CDO. (See JP 3-63.) In major combat operations, during deployment a military police commander may serve as the CDO for a theater operation.

2-6. When a corps or division serves as the higher headquarters without an AO, a military police command may not be required. When this occurs, a military police brigade may be deployed to provide C2 for detainee operations and its commander designated as the CDO.

2-7. I/R operations require robust and focused sustainment support. The presence of hundreds or thousands of detainees or refugees may challenge sustainment operations to meet the requirements to house, feed, clothe, and protect those individuals. While the sustainment of refugee populations is primarily a HN responsibility, U.S. forces must plan for, and be prepared to conduct the long-term sustainment of refugee populations, especially if the security environment is unstable, until these responsibilities can be transferred to HN organizations or the UN with support from nongovernmental organizations such as the Red Cross. (A broader discussion of I/R sustainment requirements and considerations is included in appendix J.)

DETAINEE HANDLING

2-8. Military police units are typically tasked with collecting detainees from combat units at DCPs positioned as far forward as possible. The BCT military police platoon or military police units assigned to a BCT typically operate collection points or holding areas to temporarily secure detainees until they can be evacuated to the next higher echelon's holding area. This is most critical during major combat operations, when combat units can be seriously degraded by the buildup of large numbers of detainees in the forward combat areas. During stability operations, military police unit missions may be prioritized such that the capability of limited military police assets to take control of detainees at detainee collection points limited. In these cases, non-military police units may operate collection points under the supervision of the echelon provost marshal (PM). Guard companies assigned to the military police brigade or the I/R battalion evacuate detainees from division or corps DHAs to theater internment facilities. Some detainees will be evacuated from the theater to Army level internment facilities. Military police units conducting I/R operations safeguard and maintain accountability and protect and provide humane treatment for all personnel under their care.

2-9. In a mature theater, I/R units provide C2 administration and logistical services for assigned personnel and prisoner population, or provide custody and control for the operation of a U.S. military prisoner confinement facility or a high-risk detainee internment facility. Guard companies provide guards for detainees or U.S. military prisoners, installations, and facilities.

DISPLACED CIVILIAN HANDLING

2-10. Military police units may be required to support the collection and control of DCs. In offensive, defensive, and stability operations many of the fundamentals are similar to that of handling detainees, but the focus is typically different. The handling of DCs is also a mission that may be performed in support of disaster relief or other emergencies within the United States or U.S. territories during civil support operations. As such, local, state and federal agencies are primarily responsible for handling DCs with the U.S. military in a support role. When a state of emergency is declared, the state's national guard may be called to assist with DCs under the control of the state governor or they may be federalized and conduct operations as federal U.S. military forces. (See Titles 10 and 32, U.S. Code [USC].)

2-11. Military police units performing this mission will likely have a smaller percentage of I/R units, but the expertise of I/R trained personnel will still be critical to mission success. Meeting the personal needs of DCs will typically require extensive sustainment support. The basic sustainment requirements, unique needs of DCs impacted by mission variables, and the sheer numbers of DCs may initially overwhelm relief units and organizations. Military police forces may be critical enablers in providing essential services until the HN government or other agencies can do so. The effort is typically conducted in conjunction with civilian agencies and in addition to other military police support to U.S. forces. (See chapter 10 for more information on handling DCs.)

SUPPORT TO STABILITY OPERATIONS

2-12. Stability operations are designed to establish a safe and secure environment and to facilitate reconciliation among local or regional adversaries. Stability operations can also establish political, legal, social, and economic institutions and support the transition to legitimate local government. It is essential that stability operations maintain the initiative by pursuing objectives that resolve the causes of instability. The combination of tasks conducted during stability operations depends on the situation. Stability operations consist of five primary tasks—

- Maintain civil security.
- Maintain civil control.
- Restore essential services.
- Provide support to governance.
- Provide support to economic and infrastructure development.

2-13. The primary tasks are discussed in detail in FM 3-07. Various stability operations may require focused internment operations, resettlement operations, or both; but one or the other will typically be predominant.

2-14. I/R operations in support of stability operations may become enduring and assume many of the characteristics of large-scale, maximum security prison operations that are typically found in the international civilian sector. Long-term custody and control requirements are often augmented with structured rehabilitative and reconciliation programs, increased access to medical treatment, and visitation opportunities concluding with some form of guarantor or sponsor-based release or supervised system. These operations are resource-intensive and should receive a priority commensurate with their strategic significance.

2-15. I/R operations, especially within the context of long-term stability operations, require a robust and focused sustainment effort to provide security and order while meeting basic health and sanitary needs. Too often, the scope of the detention or resettlement facility sustainment effort is not realized until health or security requirements overwhelm the logistical system. The maintenance and development of large-scale facilities is a continuous sustainment effort and often involves contractors, HN personnel, or third country nationals. The synchronization of sustainment, security, and operational requirements and efforts necessary to operate a detention or resettlement facility are complex tasks that require sufficient authority to achieve the unity of effort and security.

2-16. The military police I/R support to stability operations is central to transitioning the strategic risk of interning large numbers of combatants and civilian detainees to a strategic advantage gained from the

reintegration of informed and productive citizens at peace with their community and government. Military police may be tasked with detaining, interning, and confining enemy combatants, members of the armed forces, or civilians anywhere along the spectrum of conflict. Although military police formations have been typically organized and staffed for conducting detainee operations in high-intensity conflict, the reality is that military operations at the general war end of the spectrum of conflict are commonly of short duration compared to operations conducted at levels of violence less than general war, such as insurgency or unstable peace.

2-17. An increase in the frequency of stability operations requires more complex and sustainable systems, solutions, and facilities in support of I/R operations. Even during major combat operations, enemy forces often blend into the civilian population and criminals frequently escape or are released from jails and prisons, while government records are removed or destroyed. Criminal, terrorist, and other opportunists cross poorly secured borders and take personal or political advantage of the initial chaos that typically accompanies general warfare. Major belligerents may or may not join these or other elements (tribes, third-country nationals, or factions) to conduct insurgent activities.

2-18. During stability, the nature of the threat can often inhibit the ability of friendly forces to differentiate between a hostile act and hostile intent or between insurgents and innocents within the civilian community. For this reason, military commanders and forces must have the authority to detain civilians and an acceptable framework to confine, intern, and eventually release them back into the OE. This authority has the most legitimacy when sanctioned by international mandate or when it is bestowed or conveyed from the local or regional governmental power. The initial or baseline authority granted to military forces to use force and detain civilians will ultimately determine the status of the persons they detain. The status of detainees will further determine the manner in which they are processed, the degree of due process they are afforded, and whether their offense is military or criminal in nature. Detainee status and identification will also help develop and determine eventual rehabilitative, reconciliatory, and release strategies.

2-19. During conflict with a conventional force, the segregation of officers, enlisted personnel, civilians, and females is required when conducting internment operations and is relatively clear in its application. In contrast, due to the unconventional nature of the enemy, stability operations may be more likely to require segregation (or typology) by ethnic, tribal, or religious affiliation; human behaviors, traits, and characteristics; age groups; and other categories, to include those typically applied in combat operations. The facts and circumstances resulting in an apprehension may also determine detainee custody and control status. The goal is to isolate insurgents, criminals, and extremists from moderate and circumstantial detainees. Inaccurate assessments can have immediate and significant effects within the TIF that can result in injury or death to detainees; contribute to insurgent recruitment; or cause custody and control problems for the guard force. (See FM 3-07 and FM 3-24 for more information on stability and counterinsurgency operations.)

2-20. The theater of operations must have an effective framework to detain, assess, reconcile, transition, and eventually release detainees in a manner that is integrated with, and responsive to, the overall counterinsurgency effort. TIF commanders often support larger coordinated approaches to deliberately shape the information environment and reconciliatory efforts involving detainees. This includes various rehabilitation programs that support the overall reconciliatory efforts. The capture, detention, rehabilitation/reconciliation, and repatriation of detainees must be conducted in a manner that is consistent with the strategic end state, operational goals, and tactical realities, and also fully in compliant with the rule of law to ensure legitimacy with the population. Nowhere is this more evident than in the counterinsurgency fight.

2-21. *Counterinsurgency* is those military, paramilitary, political, economic, psychological, and civic actions taken by a government to defeat insurgency. (JP 1-02) In counterinsurgency, HN forces and their partners operate to defeat armed resistance, reduce passive opposition, and establish or reestablish the HN government's legitimacy. Military police units and Soldiers play a key role in counterinsurgency through I/R operations. (See FM 3-24.)

COUNTERINSURGENCY EFFECTS ON INTERNMENT OPERATIONS

2-22. Demanding and complex, counterinsurgency draws heavily on a broad range of capabilities and requires a different mix of offensive, defensive, and stability operations from that typically expected in major combat operations. The balance between them depends on the local situation. A successful counterinsurgency effort establishes HN institutions that can sustain government legitimacy.

2-23. The need for information is so crucial in counterinsurgency operations that it typically leads to an increased number of detainees. The time-sensitive nature of information and intelligence in counterinsurgency often leads to detentions based on incomplete or inaccurate information that makes determining detainee status and identification difficult and complex. The process of detainee identification and assessment is continuous and begins at the POC; is actively monitored during the period of detainee internment; and significantly impacts custody, control, and release decisions and strategies.

2-24. Detainee operations play a significant role in counterinsurgency efforts because large detainee populations can become fertile ground for insurgent, extremist, and criminal recruitment, development, and growth if they are not processed quickly and effectively. The development and growth of insurgent and/or criminal networks, if not identified and mitigated, can pose significant threats to I/R cadre and the detainee/DC population.

2-25. Detainee populations grow incrementally as counterinsurgency operations endure, or they can increase very rapidly during surge operations, reflecting the episodic nature of counterinsurgency. Captured insurgents display a propensity to continue recruitment, assassination, and intimidation inside TIFs, making it incumbent upon forces supporting detainee operations to focus their efforts on countering that portion of the insurgency within the facility, while synchronizing their efforts with military operations outside the detention facility.

COUNTERING THREATS WITHIN THE FACILITY

2-26. Prisons can provide insurgents with a large pool of discontented persons that may facilitate recruitment efforts by insurgent, criminal, or other irregular actors. These threats are not confined to internment operations; they are just as likely to propagate within resettlement or conventional prison operations. These irregular threat actors may also attempt to infiltrate detention or resettlement facilities to intimidate or assassinate political opponents or their supporters. The facility commander develops procedures designed to identify and defeat insurgent efforts to organize escape, harm the guard force and other detainees, or degrade the effectiveness of the facility threat operation in general. These efforts may be linked to an overarching counterinsurgency effort in the theater or may be locally initiated efforts to gain control within the facility population. The identification of a linkage to an external effort may be accomplished through and coordinating and sharing police information with an external multifunctional headquarters such as the military police command or a joint detainee task force. The military police command or joint detainee task force coordinates and synchronizes support with MI, civil affairs (CA), PSYOP and linguists; medical, legal, HN, and interagency personnel; and local leaders in an effort to defeat insurgency within the facility. Procedures or tactics, techniques, and procedures to defeat the internal threat networks and efforts within the facility may include—

- Developing deliberate procedures for detainee identification, categorization, and continual assessment.
- Using multifunctional boards to assess detainees and develop reconciliation plans.
- Identifying and designating dedicated teams with specific skill sets through mission analysis for each major compound. (The teams are organized to identify and mitigate threats within the facility and will likely include bilingual bicultural advisors; intelligence officers; counterintelligence agents; and others as required.)
- Allowing detainee participation in their own adjudication and rehabilitation destiny.
- Empowering detainee leaders to leverage their support through incentives.
- Ensuring that the informational needs of detainees are met and that rules and/or disciplinary actions are understood.

Note. Many of the techniques for identifying, segregating, and controlling personnel during resettlement operations can be similarly applied, although the level of overall control is significantly less than in an internment operation.

RELEASE OR TRANSITION

2-27. Generally, the military does not lead the planning and execution of detainee release type programs, but may establish and operate TIF reconciliation centers to ensure the continuity of detainee programs established in detention centers and reintegration efforts that conclude at the points of release back into society. The individual or large-scale release or reintegration of detainees back into the civilian community is a significant event that occurs during stability operations and can have a powerful effect in reducing the issues that created the counterinsurgency conditions. Reintegration efforts must be widely understood and visible. This is generally achieved by a deliberate information and public affairs effort. Former combatants may participate in the process when offered some level of due process involvement linked to corrective behavior modification. Commanders must seek legal assistance as they balance regulatory operations security and detainee privacy entitlements with the transparency necessary for supporting democratic institutions and national values. Military police may provide the security, custody, and control of detainees at TIF reconciliation centers and may actively conduct rehabilitative and reconciliatory programs in a command or support relationship with the headquarters responsible for an AO containing a TIF reconciliation center. (See chapter 9 for more information on detainee release or transition.)

HOST NATION TRAINING

2-28. Military police or corrections personnel may be required to provide training and advice to HN personnel for HN detention and corrections operations. Likewise, MI personnel may be required to provide training and advice to HN personnel for proper interrogation procedures. HN personnel should be trained on corrections skill level tasks to handle detainees according to internationally recognized standards for the care and treatment of prisoners or other detainees. Management procedures should provide for the security and fair and efficient processing of those detained. Effective HN internment operations that replace the need for U.S. facilities is a necessary goal of HN training.

RESETTLEMENT OPERATIONS

2-29. Resettlement operations may occur across the spectrum of operations. (See chapter 10.) Events under the category of resettlement operations include relief; chemical, biological, radiological, nuclear, and high-yield explosives (CBRNE); civil laws; and community assistance operations. Military police provide support to resettlement operations, which includes establishing and operating facilities and supporting CA efforts to ensure that supply routes remain open and clear to the maneuver commander. Additional tasks include enforcing curfews, restricting movement, checking travel permits and registration cards, operating checkpoints, instituting amnesty programs, and conducting inspections. The level of control is drastically different from that used during detainee operations. During resettlement operations, DCs are allowed the freedom of movement as long as such movement does not impede operations.

2-30. DC is a special category associated with resettlement operations. CA personnel perform the basic collective tasks during DC operations. DC operations minimize civilian interference with military operations, protect civilians from combat operations, and are normally performed with minimal military resources. Nonmilitary international aid organizations, and other NGOs are the primary resources used to assist CA forces. However, CA forces may depend on other military units, such as military police I/R units, to assist with a particular category of DCs.

2-31. Controlling DCs is essential during military operations because uncontrolled masses of people can seriously impair the military mission. Commanders plan measures to protect DCs in the AO and to prevent their interference with the mission. Military police commanders and staffs must have a clear understanding of the OE, ROE, and legal considerations before setting up a resettlement facility.

2-32. DCs are provided aid, shelter, and protection. The emphasis is on protecting them from hazardous environments or hostile actions. A special category of personnel arises when I/R operations require the housing of DCs that are detained against their will. Such is the case of mass migrants who flee their countries and find themselves under U.S. custody while policies for formal proceedings are being developed. In the case of mass migrants, I/R operations must be sensitive to the situation and attempt to strike a balance between security, shelter, protection, and detention procedures.

2-33. In an OE where hostile groups are engaged against one another, a TIF or SIF may be set up to protect one group from another. In this case, the purpose of the TIF or SIF is to shelter, sustain, account for, and protect DCs from violence. Designated units concentrate on providing area security to protect the I/R facility from direct fire. Other military police or combat forces provide protection beyond the direct-fire zone. The accountability for DCs is coordinated with the SJA and CA. Military police focus on maintaining a record of the people in the I/R facility and their physical conditions. In a semi-permissive environment, the UN mandate or ROE may include the authority to detain civilians that are a threat to a secure and stable environment. Military police units may be required to establish CI detention facilities for this purpose. In operations where no hostile groups are engaged (such as natural disasters), the I/R facility may be set up to provide shelter, food, and water and to account for personnel. There may not be a need for external security personnel.

2-34. The C2 structure of I/R and other military police units for stability or civil support operations is based on the mission variables. The nature and complexity of the mission, number and type of detainees and/or DCs, and operational duration should be considered. For example, smaller operations may require a single I/R battalion while larger operations may require I/R battalions within a military police brigade to meet operational requirements.

Note. Resettlement conducted as a part of civil support operations will always be conducted in support of another lead agency (Federal Emergency Management Agency, Department of Homeland Security).

U.S. MILITARY PRISONERS

2-35. Military police units detain, sustain, protect, and evacuate U.S. military prisoners. When possible, Soldiers awaiting trial remain in their units. Commanders may request a judge to impose pretrial confinement when reasonable grounds exist to believe that the Soldier will not appear at the trial, the pretrial hearing, or the investigation or that they will engage in serious criminal misconduct. Under these pretrial confinement instances, the commander must also reasonably believe that a less severe form of restraint (such as conditions of liberty, restriction in lieu of apprehension, or apprehension) is inadequate. When these circumstances exist and other legal requirements are met, U.S. military personnel may be placed in pretrial confinement under the direct control of military police. Convicted military prisoners are moved as soon as possible to confinement facilities outside the operational area.

2-36. U.S. military prisoner confinement operations parallel, but are separate from, the other types of I/R operations. No member of the U.S. armed forces may be placed in confinement in immediate association with a detainee who is not a member of the U.S. armed forces. A temporary confinement facility for U.S. military prisoners may be maintained in an operational area only if distance or the lack of transportation to a higher facility requires this. When U.S. military prisoners are retained in the theater, temporary field detention facilities may be established. (See AR 190-47.)

RESETTLEMENT OPERATIONS RESULTING FROM POPULATION AND RESOURCE CONTROL

2-37. Population and resource control denies adversaries or insurgents access to the general population and resources and prevents incidental civilian activity from interfering with military operations. Military police units support local commanders and often assist CA personnel in planning and conducting population and resource control programs employed during all military operations. This assistance may consist of training HN police and penal agencies and staffs, conducting law and order operations, enforcing curfews and movement restrictions, resettling DCs, conducting licensing operations, controlling rations, enforcing

regulations, implementing amnesty programs, inspecting facilities, and guarding humanitarian-assistance distributions.

2-38. Military police units also assist, direct, or deny DCs the use of main supply routes as they move to resettlement camps where they are cared for and while NGOs often work to coordinate their relocation. Military police I/R units are specifically trained to provide care and shelter for DCs.

SUPPORT TO CIVIL SUPPORT OPERATIONS

2-39. *Civil support* is the DOD support to U.S. civil authorities for domestic emergencies, and for designated law enforcement and other activities. (JP 3-28) Civil support includes operations that address the consequences of natural or man-made disasters, accidents, terrorist attacks and incidents in the U.S. and its territories.

2-40. The I/R tasks performed in support of civil support operations are similar to those during combat operations, but the techniques and procedures are modified based on the special OE associated with operating within U.S. territory and according to the categories of individuals (primarily DCs) to be housed in I/R facilities. During long-term I/R operations, state and federal agencies will operate within and around I/R facilities within the scope of their capabilities and identified role. Military police commanders must closely coordinate and synchronize their efforts with them especially in cases where civil authority and capabilities have broken down or been destroyed.

ARMY COMMAND AND SUPPORT RELATIONSHIPS

2-41. Most military police units are typically assigned, attached, or placed under the operational control of military police brigades or military police commands when one or more is committed to an operation. The senior military police commander will normally be designated as the CDO for all detainee operations in the AO. This includes organizing and employing commands and units, assigning tasks, designing objectives, and giving directions to accomplish the mission. Military police C2 relationships may be changed briefly to provide better support for a specific operation or to meet the needs of the supported commander. Support relationships define the purpose, scope, and effect desired when one capability supports another. (See FM 3-0 for more information on command and support relationships.)

2-42. Within the military police structure, attached units that participate in I/R operations are under the command of the senior military police officer present at each echelon. Units and personnel (such as HUMINT, counterintelligence, medical, and SJA) that support or are associated with I/R operations are normally placed in a tactical control relationship to the military police commander or the platoon leader at the BCT level when they are operating inside the DCP, DHA, or fixed I/R facility. MI and medical units/personnel continue to operate within the guidance and direction of their technical channels to ensure that the technical aspects of their activities are not impeded.

2-43. *Technical channels* are the transmission paths between two technically similar units or offices within a command that perform a technical function require used to control performance of technical functions. They are not used for conducting operations or supporting another unit mission. (FM 6-0) It is critical to the overall success of operations that elements have unfettered access to their parent organizations or technical staff channels. Technical channels apply exclusively to certain specialized functions as follows:

- MI personnel will remain under the direction of their MI technical channels for interrogation activities and intelligence reporting. These channels remain intact as a procedural control measure for interrogation operations to provide technical guidance, allow proper technical management, ensure adherence to applicable laws and policies, and guide the proper use of doctrinal approaches and techniques during the conduct of interrogation operations.
- Medical personnel operate within similar technical channels. These technical channels should never be circumvented or disrupted by personnel outside the medical chain. All medical personnel and assets are under the technical supervision of the detainee operations medical director.
- All HUMINT units are under the direction of the facility commander for the humane treatment, evacuation, and custody and control (reception, processing, administration, internment, and

safety) of detainees; protection measures; and internment facility operation. The MI unit commander is responsible for the conduct of interrogation operations, to include prioritizing effort and controlling the technical aspects of interrogation or other intelligence operations. The intelligence staff maintains control over interrogation operations through technical channels according to the commander's intent and plans, orders, and established unit SOPs to ensure adherence to applicable laws and policies. Applicable laws and policies include U.S. laws, the law of war, relevant international laws, relevant directives (including DODD 3115.09 and DODD 2310.01E), DODIs, execution orders, and FRAGOs. The assistant chief of staff, HUMINT and counterintelligence (G-2X) or joint force HUMINT and counterintelligence staff element (J-2X) controls all HUMINT and/or counterintelligence units through technical channels.

- The joint interrogation and debriefing center (JIDC) or MI battalion must receive intelligence collection priorities from the G-2X or J-2X elements and have some degree of autonomy to complete its vital intelligence mission for the commander. Military police should not establish intelligence priorities for the JIDC.
- Military police use technical channels to ensure that I/R and law and order functions are conducted according to applicable regulations and U.S. and international laws. Within I/R operations, technical channels are especially critical at DCPs and DHAs where military police conducting operations may require advice and guidance from senior military police staff. Technical staff assistance may also flow through the BCT PM to advise BCT commanders and staffs regarding DCP operations when military police are not available to take control of detainees.

CONSIDERATIONS WITHIN THE OPERATIONAL AREA AND THE AREA OF OPERATIONS

2-44. Each combatant commander is assigned a geographic area of responsibility. Within the area of responsibility, the combatant commander has the authority to plan and conduct operations. Joint force commanders at all levels may establish subordinate operational areas within the area of responsibility, such as AOs, joint operations areas, joint special operations areas, and joint security areas. The joint security areas facilitate the protection and operation of bases, installations, and the U.S. armed forces that support combat operations.

2-45. During major combat operations, the POC for most detainees will typically be in a BCT AO. A DCP will normally be located within the brigade area. The military police platoon organic or assigned to the BCT typically establishes the DCP as close to the POC as possible, many times within a battalion AO, to temporarily secure detainees until they can be moved to the next higher echelons DHA. The DCP is an austere site established as a temporary holding area within the BCT AO to provide security and ensure the humane treatment of detainees pending movement to a DHA or TIF. The DHA and TIF are typically outside a BCT AO. (See paragraph 6-13.) The DHA is a temporary holding area normally established within the division area (typically outside the maneuver BCTs AO, but potentially in the AO of a maneuver enhancement brigade [MEB]) to receive detainees from the DCPs, provide security, and ensure humane treatment of detainees pending movement to a facility outside the division area. (See paragraph 6-25.) Detainees are held at the DCP or DHA until transportation is available and time-sensitive exploitation by MI personnel has been completed.

2-46. During stability operations, many more DCPs and DHAs may be required, based on mission variables and detainee flow. In these instances, locations for DCPs and DHAs typically may be established at an echelon lower than in major combat operations. For example, DCPs may be established within battalion AOs and DHAs established within BCT AOs. Additionally, the high demand for military police technical capabilities within TIF and in support of HN policing operations may create a shortage of military police available to support the BCT, establishing a requirement for BCTs to operate DCPs and DHAs with nonmilitary police personnel. In these instances, it is critical that the echelon PMs are heavily involved to ensure that detainees are cared for and processed according to ARs and U.S. and international laws. The military police technical channels are available to the echelon PM and BCT commanders to provide technical advice and guidance regarding detainee operations.

2-47. Typically, a TIF or SIF is established at the theater level. (See paragraph 6-59.) A TIF or SIF is a permanent or semipermanent facility that is normally within the regional area of combat operations and designed to hold large numbers of detainees for extended time periods. All TIFs and SIFs are operated under military police C2, with augmentation and support of many of the military disciplines. The decision may be made to establish a TIF or SIF outside the theater of operations that is not under the authority of a theater commander.

Chapter 3

Command and Staff Roles and Responsibilities

I/R operations consist of complex measures that are necessary to guard, protect, assist, and account for individuals who are captured, detained, confined, or evacuated from their homes. C2 of I/R operations involves the resources and synchronized efforts of multidisciplinary functions and personnel. Clear C2 is essential for seamless operations to ensure that the principles of I/R operations are obtained. These operations must not distract from simultaneous military operations, which are essential to mission success. Each distinct I/R operation—whether focused on detainee operations, DC operations, or battlefield confinement of U.S. military prisoners—requires a somewhat different C2 structure to handle the diverse categories of individuals under U.S. protection and control. Within the Army and through the combatant commander, military police are tasked with coordinating for shelter, protection, and sustainment, while ensuring accountability procedures for detainees and U.S. military prisoners. They will also perform some or all of these when dealing with DCs, depending on the specific nature of the situation (to include whether they are U.S. citizens).

NATIONAL AND THEATER REPORTING AGENCIES

- 3-1. The NDRC (a Headquarters, DA organization assigned to the OPMG) is responsible for—
- Assigning and forwarding blocks of ISNs to the designated theater and the continental United States (CONUS) as required.
 - Obtaining and storing information concerning detainees and their confiscated personal property.
 - Preparing reports for the protecting power.
 - Providing accountability information to the ICRC central tracing agency.
 - Acting as the proponent office for the Detainee Reporting System and detainee management software.
- 3-2. The TDRC is a modular organization that is comprised of 32 personnel who are capable of deploying as a full organization in major combat operations as a team or a combination of up to 4 teams to support small-scale operations. It functions as the field operations agency for the CONUS-based NDRC. It is the central agency responsible for maintaining information on detainees and their personal property within an assigned theater of operations or in CONUS. The TDRC is a theater asset that provides detainee data management. The TDRC normally colocalizes with the CDO staff, but may be located at the TIF in small-scale operations.
- 3-3. The TDRC serves as the theater or area of responsibility repository for information pertaining to detainees. The TDRC is responsible for—
- Accounting for I/R populations and ensuring the implementation of DOD policies.
 - Providing initial blocks of ISNs to the area processing organization and requesting ISNs from the NDRC as required.
 - Obtaining and storing accountability information concerning I/R populations originating within the theater or area of responsibility.
 - Establishing and enforcing the accountability information requirements that the U.S. armed forces collect. (The TDRC receives these requirements from the NDRC.)
 - Ensuring detainee property accountability within detention facilities.

3-4. The CDO is responsible for ensuring that information regarding I/R populations is transmitted to the NDRC and/or civilian organizations. In the absence of a TDRC, the CDO must coordinate through the NDRC to ensure that reporting requirements are met.

ROLES AND RESPONSIBILITIES

3-5. A clear understanding of the roles and responsibilities of each organization, agency, and corresponding primary positions of responsibility is essential to effective mission execution. The following are categories of I/R populations and the various commanders and staffs or multifunctional agencies that are involved in the support of I/R operations:

- **Detainees.** The Army is the DOD executive agent for detainee operations. The Secretary of Defense, Provost Marshal General (PMG), combatant commander, joint task force commander, theater PM, and ICRC, along with their respective support staffs, are involved in internment operations involving detainees. (Detailed guidance for detainee operations that incorporate lessons learned from recent operations in the war on terrorism are presented in chapter 5).
- **U.S. military prisoners.** The Army is the DOD executive agent for long-term confinement of U.S. military prisoners. U.S. military prisoners must be guarded to prevent escape and cannot be confined in immediate association with detainees, DCs, or other foreign nationals who are not members of the U.S. armed forces. The PMG; commander, U.S. Army Corrections Command; theater PM and the chain of command, along with their respective support staffs, are all involved in the confinement process for U.S. military prisoners. (Detailed guidance for battlefield confinement of U.S. military prisoners is presented in chapter 7.)
- **DCs.** DCs are kept separate from detainees and U.S. military prisoners. DCs are controlled to prevent interference with military operations and to protect them from combat. DCs may also require assistance during natural or man-made disasters and subsequent humanitarian-assistance missions. The Department of Homeland Security, Secretary of Defense, Secretary of the Army, and UN High Commissioner for Refugees, along with their respective support staffs, are involved in resettlement operations to support and protect DCs. (Detailed guidance for military police support to humanitarian-assistance operations and emergency services is presented in chapter 10.)

SECRETARY OF DEFENSE

3-6. The Secretary of Defense has overall responsibility for matters relating to detainees or DCs. Within the DOD, the Under Secretary of Defense for Policy provides for the overall development, coordination, approval, and implementation of major DOD policies and plans relating to I/R operations, including the final coordination of proposed plans, policies, and new courses of action with DOD components and other federal departments and agencies as necessary. The specific division responsible for I/R policy issues within the office of the Under Secretary of Defense for Policy is the Deputy Assistant Secretary of Defense for Detainee Affairs. The DOD general counsel provides legal advice to the Secretary of Defense and DOD on detainee matters.

SECRETARY OF THE ARMY

3-7. The Secretary of the Army is designated as the DOD executive agent for the DOD detainee program (DODD 2310.01E) and in that role—

- Ensures that responsibilities and functions of the DOD detainee program according to DODD 2310.01E are assigned and executed.
- Develops and promulgates program guidance, regulations, and instructions necessary for the DOD-wide implementation of DODD 2310.01E.
- Communicates directly with the heads of DOD components, as necessary, to carry out assigned functions.
- Designates a single point of contact (within the DA) who will also provide advice and assistance to the Office of the Deputy Secretary of Defense for Detainee Affairs and the Undersecretary of Defense for Policy for detainee operations.

- Plans for and operates the NDRC and its elements to account for detainees. The Secretary of the Army coordinates with the Undersecretary of Defense for Policy to provide reports on detainee operations to the Secretary of Defense and others as appropriate.
- Recommends DOD-wide detainee affairs related planning and programming guidance to the—
 - Undersecretary of Defense for Policy.
 - Under Secretary of Defense for Acquisition, Technology, and Logistics; Intelligence; Personnel and Readiness; and Comptroller.
 - Assistant Secretary of Defense for Networks and Information Integration.
 - Director of Program Analysis & Evaluation.
 - Chairman of the Joint Chiefs of Staff (CJCS).

Note. Provide copies of such guidance to the secretaries of military departments.

- Establishes detainee operations training and certification standards in coordination with the secretaries of the military departments and the joint staff.
- Develops programs to ensure that all DOD detainee operations policies; doctrine; tactics, techniques, and procedures; and regulations or other issuances are periodically reviewed and evaluated for effectiveness and compliance with DOD policies.

PROVOST MARSHAL GENERAL

3-8. The Secretary of the Army further designates the PMG as the Secretary of the Army action agent to exercise the executive agent role for detainee operations and long-term confinement of U.S. military prisoners. The PMG develops and disseminates policy guidance for the treatment, care, accountability, legal status, and processing of detainees. The PMG provides Headquarters, DA, staff supervision for the DOD and ensures that plans are developed for providing ISNs to the TDRC and replenishing ISNs.

- 3-9. The PMG provides staff assistance and technical advice to various agencies, including—
- Office of the Secretary of Defense.
 - Joint Chiefs of Staff.
 - Military departments.
 - Combatant commands.
 - Department of State and other federal agencies.
 - NGOs.

COMMANDER, U.S. ARMY CORRECTIONS COMMAND

3-10. The U.S. Army Corrections Command mission is to exercise C2 and operational oversight for policy, programming, resourcing, and support of Army Corrections System facilities and table of distribution and allowances elements worldwide. On order, the U.S. Army Corrections Command coordinates the execution of condemned military prisoners. Strategic objectives include—

- Providing a safe environment for the retributive incarceration of prisoners.
- Protecting communities by incarcerating prisoners.
- Deterring those who might fail to adhere to discipline laws and rules.
- Providing rehabilitation services to prepare prisoners for release as civilians or for return to duty with the prospect of being productive Soldiers/citizens.
- Supporting commanders worldwide by developing detainee experts through experiential learning in a prison environment.

COMBATANT, TASK FORCE, AND JOINT TASK FORCE COMMANDERS

3-11. Combatant, task force, and joint task force commanders have the overall responsibility for I/R operations and contingency plans in their area of responsibility. They ensure compliance with the law of

war and applicable U.S. policies and directives and receive guidance from the Secretary of Defense. They—

- Issue and review appropriate plans, policies, and directives as necessary.
- Plan, execute, and oversee detainee operations according to DODD 2310.01E.
- Ensure that all members of DOD components, contract employees, and others assigned to or accompanying DOD components are properly trained and certified and are maintaining records of training and certification.
- Provide for the proper treatment, classification, administrative processing, and custody of those persons captured or detained by military services under their C2.
- Ensure that detainee and DC accountability is maintained using the Detainee Reporting System (the official NDRC Data Collection System for processing detainees and issuing ISNs).
- Ensure that suspected or alleged violations of the law of war are promptly reported to the appropriate authorities and investigated.
- Ensure that personnel deployed in operations across the spectrum of conflict are cognizant of their obligations under the law of war.
- Designate a CDO. (The CDO is responsible for all detainee operations and has command over all detention and interrogation facilities within an AO. The CDO will typically be the senior military police commander in a theater.)
- Are responsible for all facets of the operation of internment facilities (theater and strategic) and all facility-related administrative matters.
- Ensure that detention operations comply with the principles of the Geneva Conventions and the intent of the commander in chief.
- Support and improve the intelligence-gathering process with everyone who has contact with detainees.

COMMANDER, DETAINEE OPERATIONS

3-12. The CDO is typically responsible for all detention facility and interrogation operations in the joint operations area. The CDO should have detainee operations experience and will normally be the senior military police commander. If the size and scope of the detainee operation warrants, the joint force commander may consider designating a general or flag officer as the CDO. (See JP 3-63.) The CDO does not normally perform duties as the operating commander of an I/R facility. MI and medical units or personnel will retain control of their respective activities through technical channels. For example, the CDO—

- Reports directly to higher headquarters on detainee matters.
- Establishes a technical chain of command with medical and MI assets operating within the facility.
- Exercises control over assets performing detainee interrogation operations at the theater level; however, the JIDC retains technical authority for interrogation functions and intelligence reporting.
- Ensures effective communication between JIDC personnel and detention facility commanders.
- Reviews interrogation plans. (The CDO does not establish interrogation priorities, but will work with the detainee operations staff and higher headquarters to resolve any issues with implementing the interrogation plan according to the approved Army forces standards for interrogations. The CDO does not approve or disapprove interrogation plans.)
- Provides policies and operational oversight, to include developing and disseminating detainee policies, directives, and operation orders.
- Ensures that U.S. armed forces who are conducting detainee operations comply with the law of war and U.S. laws, regulations, and policies.
- Ensures that other government agencies adhere to DOD policies and procedures while performing detainee interrogation operations at DOD facilities.

Note. The CDO and his/her designated representatives will have unfettered access to all areas and operations.

- Ensures that allegations of mistreatment are immediately reported through the chain of command and investigated by the Military Criminal Investigation Organization according to U.S. policies.
 - Ensures that ISNs are issued according to current policies and procedures (normally conducted at the TIF level).
 - Ensures that detainee accountability and reporting are done properly through the TDRC to the NDRC.
 - Ensures that detainee board processes are supervised.
 - Coordinates visits from representatives of the ICRC and/or protecting powers.
 - Coordinates external visits to detainees.
 - Coordinates sustainment requirements across the spectrum of detainee operations.
-

Note. Sustainment requirements normally range from the establishment of internment facilities through sustained operations to the final transition and disposition of internment facilities and detainees.

- Plans the transition of detainee operations from U.S. armed forces to the HN, to include—
 - Planning and building long-term internment facilities for transitioning detainees to HN prisons.
 - Coordinating with the appropriate DOD authorities, HN government authorities, HN penal authorities, and protecting powers for planning and implementing the transition and transfer of internment facilities and detainees.
 - Coordinating with other government agencies to support HN corrections and guard force training programs.
 - Coordinating with the HN judicial system for disposition of criminal cases.
 - Coordinating with HN authorities for the release or repatriation of detainees.
 - Accounting for and transferring detainee records (including photographs), personal property, and evidence to the HN penal/judicial authorities.

DETENTION FACILITY COMMANDER

3-13. The detention facility commander is the commander for an individual detention facility. The detention facility commander normally does not serve as a CDO when also functioning as a TIF commander. In internment facilities, the detention facility commander ensures, at a minimum, that—

- Internment operations are conducted according to applicable laws and policies.
- Members of the staff and command are thoroughly familiar with applicable ARs, SOPs, directives, international laws, and administrative procedures.
- Facility personnel are trained on facility SOPs, applicable ARs, directives, international laws, and administrative procedures.
- The safety and well-being of all personnel operating and housed within the internment facility are maintained.
- All personnel are properly trained on the RUF and are familiar with the law of land warfare and other applicable laws and policies.
- Standards, policies, and SOPs (for detainee operations) are developed and implemented to ensure compliance with AR 190-8 and that all personnel have an effective knowledge of the internment facility SOP.
- Suitable interrogation space and resources, to include provisions for live monitoring, are provided within the internment facility to facilitate the intelligence collection mission. Provisions may also include medical, security, and administrative support.

- Coordination is made with the base commander, JIDC commander, and medical and other assets regarding facility protection.

3-14. When operating in detention facilities, HUMINT collectors and medical personnel are under the direction of the detention facility commander for actions involving the humane treatment, custody, and evacuation of detainees and for facility protection. Tactical control does not include the prioritization of interrogations by HUMINT personnel or intelligence and medical operations within the facility. MI and medical units or personnel will retain technical authority for their activities from the MI and medical higher headquarters, respectively. For instance, MI personnel will receive operational guidance through the MI technical chain of command for interrogation activities and intelligence reporting. Guidance obtained through technical channels for intelligence and medical personnel may include—

- Ensuring that applicable U.S. laws and regulations, international laws, execution orders, FRAGOs, and other operationally specific guidelines (for example, DOD policies) are followed.
- Ensuring that approved doctrinal approaches and techniques are used properly.
- Providing technical guidance for interrogation activities.

3-15. The detention facility commander coordinates closely with MI personnel to permit the effective accomplishment of military police and MI missions at the facility by—

- Conducting regular coordination meetings with the interrogation element.
- Developing an SOP (in conjunction with the JIDC commander and/or senior interrogator) to deconflict the internment and interrogation missions. Considerations include—
 - The need for military police and MI personnel to use incentives for different purposes and at different times. The proper coordination between military police and MI personnel is necessary so that, when interrogators promise an approved incentive to a detainee, the military police ensure that the detainee receives the incentive and is allowed to retain it. The use of incentives must be coordinated with, and approved by, the detention facility commander. The provision and withdrawal of incentives may not affect the baseline standards of humane treatment. For example, military police may provide incentives such as special food items. When those incentives are withdrawn, however, military police must still provide the normal rations. Failure to cooperate in an intelligence interrogation cannot result in disadvantageous treatment. The withdrawal of incentives provided to similarly situated detainees must be based on disciplinary reasons or reasons of security, not failure to cooperate with HUMINT interrogations.
 - A system of information exchange between the military police and interrogators about the actions and behaviors of detainees and other significant events associated with detainees.
 - The interrogation chain of command's coordination on the interrogation plan with the CDO. The CDO (in conjunction with the MI commander) may convene a multidiscipline custody and control oversight team including, but not limited to, military police personnel, MI personnel, a behavioral science consultant (if available), and legal representatives. The team can advise and provide measures to ensure that effective custody and control is used and compliant with the requirements of applicable U.S. laws and regulations, international laws, execution orders, FRAGOs, and other operationally specific guidelines. Guards do not conduct intelligence interrogations and will not set the conditions for interrogations. Guards may support interrogators as additional security (for example, for combative detainees) according to JP 3-63, FM 2-22.3, and the approved interrogation plan.
 - The maintenance of an effective, two-way communications system between military police and MI elements.
- Training personnel at the internment facility for the mutual understanding of military police and MI missions. Interrogation operations familiarization training for military police.
- Providing suitable interrogation space and resources within the internment facility to facilitate the intelligence collection mission.
- Authorizing outside access to MI-held detainees only when coordinated with the interrogation element and G-2X and/or J-2X.

3-16. With specific regard to detainees, the detention facility commander—

- Is responsible for the administrative processing of each detainee. (When processing is complete, DA Form 2674-R [*Enemy Prisoner of War/Civilian Internee Strength Report*] is transmitted to the TDRC.)
- Ensures that detainees are treated humanely. (The detention facility commander will have unfettered access to all areas and operations.)
- Immediately reports allegations of detainee mistreatment immediately through the appropriate chain of command.
- Ensures that cadre and support personnel understand the different rules and procedures applicable to each category of detainee. (Military police leaders and Soldiers must be constantly aware of the category of personnel they are handling and enforce the applicable rules and regulations.)
- Ensures that the following items are posted in each facility in English and the language of the detainees housed there, and makes them available to those without access to the posted copies:
 - Geneva Conventions.
 - Facility regulations, orders, and notices (printed in the languages of detainees and/or depicted in such a manner as to ensure understanding by all detainees in the facility) relating to the conduct and activities of detainees.

3-17. The detention facility commander maintains a copy of, and strictly accounts for, all documents (including photographs) on file as designated by the SOP or by command policies. Commanders provide copies to all DOD and Army assessment or investigative authorities as requested, ensure safe and proper storage, and account for records in archives.

3-18. Regulations and other guidance relative to the administration, employment, and compensation of detainees are prescribed in detail in AR 190-8, Department of Finance and Accounting Service–Indianapolis (DFAS-IN) 37-1, FM 1-06, FM 4-02, and FM 27-10.

JOINT INTERROGATION AND DEBRIEFING CENTER COMMANDER/MILITARY INTELLIGENCE BATTALION

3-19. The JIDC commander is responsible for matters relating to interrogations, intelligence collection and reporting, and interaction with other agencies involved in the intelligence and/or evidence-gathering process. The JIDC is normally commanded by an MI officer, who is operational control to the CDO and tactical control to the TIF commander for humane treatment, evacuation, and custody and control (reception, processing, administration, internment, and safety) of detainees; protection measures; and operation of the internment facility. The JIDC commander is responsible for the conduct of interrogation operations, to include the prioritization of effort and control of interrogation or other intelligence operations. The JIDC maintains a technical direction relationship through MI channels for interrogation functions and intelligence reporting. Other responsibilities may include, but are not limited to, the following:

- Developing and implementing synchronized tactics, techniques, and procedures that comply with applicable U.S. laws and regulations, international laws, execution orders, FRAGOs, and other operationally specific guidelines (DOD policies).
- Coordinating with the detention facility commander to ensure that the roles and responsibilities of HUMINT collectors and military police are understood and applied throughout all phases of detainee operations.
- Coordinating with the detention facility commander for MI personnel participation in base operations support, to include tenant unit security, interpreter support, sustainment support, and processing-line screening.
- Keeping the CDO informed of interrogation operations.
- Establishing and maintaining technical guidance channels to G-2X and/or J-2X assets.

- Executing interrogation and debriefing operations according to the priorities and guidance outlined by the G-2X and/or J-2X (as the asset manager for interrogation operations at the JIDC).
- Coordinating with the military criminal investigative organization and legal agencies for evidentiary measures and resolutions as required.

3-20. The JIDC normally operates within a permanent or semipermanent facility, is administratively and operationally self-sufficient, and develops a logistical relationship with the parent unit manning the internment facility. The JIDC—

- Normally consists of a facility headquarters and operations, analysis, interrogation, and screening sections.
- Is located within the TIF.
- Is structured to meet mission variable requirements within the theater.
- Includes HUMINT collectors who are trained in interrogation operations; counterintelligence personnel; personnel for captured enemy documents; and intelligence analysts (as applicable) from the Army, Air Force, Marine Corps, Navy, and other government agencies.
- Maintains the capability to deploy HUMINT collection teams forward as needed to conduct interrogations or debriefings to sources of interest that cannot be readily evacuated to the JIDC.
- Often establishes a combined interrogation facility with multinational HUMINT collectors or interrogators if operating as part of a multinational operation.

INTELLIGENCE ANALYSTS

3-21. Research analysts perform the following duties:

- Research the background of detainees utilizing the source analysis of available data to place the detainee into context for collectors.
- Analyze, combine, and report intelligence information collected through the interrogation and/or debriefing process for the purpose of validating collected information and identifying related intelligence gaps.
- Develop indicators for each intelligence requirement to support screening operations; develop detainee-specific collection requirements for collectors.
- Develop and maintain the database and organize collected information for local and customer use.
- Make recommendations to the detention facility commander for release/transfer of detainees.

HUMAN INTELLIGENCE COLLECTORS

3-22. HUMINT collectors perform the following duties:

- Develop indicators for each intelligence requirement to support screening operations.
- Make recommendations to the detention facility commander for the release/transfer of detainees.
- Provide recommendations to the detention facility commander concerning the segregation of detainees. (See FM 2-22.3.) (HUMINT collectors must request approval to employ the restricted interrogation technique of separation. The combatant commander must approve the use of separation. The first general/flag officer in their chain of command must approve each interrogation plan that uses separation. FM 2-22.3, appendix M, must be followed.
- Report information collected through the interrogation process.
- Conduct intelligence interrogations, debriefings, or tactical questioning to gain intelligence from captured or detained personnel humanely, according to applicable law and policies.
- Ensure that interrogation techniques are implemented according to applicable laws and policies.
- Develop interrogation plans according to the unit SOP before conducting an interrogation.
- Disseminate screening reports to potential users on a timely basis.

INTERPRETERS AND TRANSLATORS

3-23. Unless otherwise authorized by the joint force commander, only individuals with the proper training and appropriate security level are allowed within the confines of the facility to perform interpreter/translator duties (for example, multinational members). Categories of contract interpreters include—

- **Category I linguists.** Category I linguists are locally hired personnel who have an understanding of the English language. They undergo a limited screening and are hired in the theater. They do not possess a security clearance and are used for unclassified work. During most operations, Category I linguists require rescreening on a scheduled basis. Category I linguists should not be used for HUMINT collection operations.
- **Category II linguists.** Category II linguists are U.S. citizens who have a native command of the target language and a near-native command of the English language. They undergo a screening process, which includes a national agency check. Upon favorable findings, they are granted an equivalent of a Secret collateral clearance. This is the category of linguist most used by HUMINT collectors.
- **Category III linguists.** Category III linguists are U.S. citizens who have native command of the target language and native command of the English language. These personnel undergo a screening process, which includes a special background investigation. Upon favorable findings, they are granted an equivalent of a top secret clearance. Category III linguists are normally used for high-ranking official meetings and strategic collectors.

DETAINEE OPERATIONS MEDICAL DIRECTOR

3-24. The theater Army Surgeon for the Army Service component command designates a detainee operations medical director to oversee the aspects of medical care provided to detainees. This director establishes and maintains technical guidance and supervision over medical personnel who are engaged in providing health care to detainees, regardless of unit assignment. The detainee operations medical director—

- Advises the CDO and theater commander on the health of detainees.
- Provides guidance, in conjunction with the command judge advocate, on the ethical and legal aspects of providing medical care to detainees.
- Recommends the task organization of medical resources to satisfy mission requirements.
- Recommends policies concerning the medical support for detainee operations.
- Develops, coordinates, and synchronizes health consultation services for detainees.
- Evaluates and interprets medical statistical data.
- Recommends policies and determines requirements and priorities for medical logistics operations in support of detainee health care, to include blood and blood products, medical supply and resupply, medical equipment, medical equipment maintenance and repair services, formulary development, optometric support, single vision and multivision optical lens fabrication, and spectacle repair.
- Strictly accounts for and maintains medical records (to include photographs) on detainees according to AR 40-66 and AR 40-400.
- Recommends medical evacuation policies and procedures and monitors medical evacuation support to detainees.
- Recommends policies, protocols, and procedures pertaining to the medical and dental treatment of detainees. (These policies, protocols, and procedures provide the same standard of care provided to U.S. armed forces in the same area.)
- Ensures that monthly weigh-ins are conducted and reported for detainees who are held in medical facilities as required by regulations.
- Plans and implements preventive medicine operations and facilitates health risk communications, to include implementing preventive medicine programs and initiating preventive medicine measures to counter the medical threat.

- Ensures that medical personnel are trained in the medical aspects of the Geneva Conventions.
- Ensures that health care providers are appropriately credentialed and that their scope of practice is defined.
- Ensures that detainee medical history is recorded in the Detainee Reporting System per AR 190-8. The minimum required data is—
 - Monthly height/weight.
 - Immunizations.
 - Initial medical assessment.
 - Prerelease/repatriation medical assessment.
- Upon the death of a detainee, coordinates with the Armed Forces Medical Examiner who will determine if an autopsy is required. (The remains are not released from U.S. custody without authorization from the Armed Forces Medical Examiner and the responsible commander except by waiver from the Deputy Assistant Secretary of Defense for Detainee Affairs or his designated representative.)

MILITARY POLICE ORGANIZATIONS IN SUPPORT OF INTERNMENT AND RESETTLEMENT OPERATIONS

3-25. The type and quantity of units conducting I/R operations vary from echelon to echelon based on mission variables, higher directives, and the scope and nature of the mission. The types of military police units that may be involved in I/R operations are discussed in the following paragraphs. (See appendix B and FM 3-39.)

MILITARY POLICE COMMAND

3-26. The MPC is a theater level organization that is responsible for military police functions performed at echelons above corps. Military police organizations performing military police functions at echelons above corps will typically be task-organized under the MPC. The MPC commander (usually a general officer) is normally designated as the CDO for the entire theater of operations and reports directly to the theater commander or a designated representative. The MPC is responsible for implementing theater-wide standards and ensuring compliance with established DOD and DA detainee policies. In addition, the MPC provides policy oversight to ensure compliance with theater-specific I/R policies and procedures. As required, exercises tactical/operational control of tactical combat forces that are conducting theater level response force operations.

MILITARY POLICE BRIGADE

3-27. Military police brigades are task-organized under an MPC or under a division or corps headquarters. Military police brigades provide C2 to two to five military police battalions that are performing military police functions, to include I/R operations. With organic or appropriate organizational augmentation, military police brigades can provide C2 for long-term detention operations at theater, corps, or division levels. In the absence of an MPC, a military police brigade commander may serve as the CDO for a theater or specific AO.

MILITARY POLICE BATTALIONS

3-28. There are three categories of battalions within the Military Police Corps Regiment that are involved with I/R operations—military police, I/R, and CID—and each type of battalion has a specific role.

- Military police battalions, with the appropriate organizational augmentation, can provide C2 for short- and long-term I/R operations.
- I/R battalions are specifically designed to establish and provide C2 for long-term I/R operations. I/R battalions are normally employed at the TIF level or higher, with the I/R battalion commander serving as the TIF commander.

- CID battalions, provide C2 for criminal investigations of felony crimes according to AR 195-2, including those associated with I/R operations. It has a supporting, rather than primary, role in I/R operations.

3-29. In small-scale contingency operations or in the absence of a higher military police headquarters, an I/R or military police battalion commander may serve as the CDO.

3-30. The military police and I/R battalions are structured to provide C2 of two to five companies or elements. A military police or I/R battalion is capable of planning, integrating, and directing the execution of military police missions conducted by a mix of military police companies. Either battalion may be found within the military police brigade, the MEB, or in support of a BCT. I/R battalions may C2 a task-organized force that consists of military police, MI, legal, medical, and other specialties required for I/R operations. A military police or I/R battalion may support an MEB in an I/R role.

MILITARY POLICE COMPANIES

3-31. There are three types of companies within the Military Police Corps Regiment—military police, I/R, and guard. Similar to military police battalions, each company provides specific capabilities in regards to I/R operations, and correspondingly, focus their support on different aspects of I/R operations.

- Military police companies can perform facility security, transport/escort security, and external facility protection.
- Guard companies with limited wheeled vehicles and weapons platforms typically provide facility security and transport/escort security for I/R operations. I/R companies are specially designed for long-term, close-contact I/R operations. All I/R companies have the ability to perform detainment tasks as part of contingency operations or confinement duties at permanent U.S. military corrections facilities.

INTERNMENT AND RESETTLEMENT DETACHMENTS

3-32. There are four types of military police detachments specifically designed for I/R operations—I/R detachment, TDRC, camp liaison detachment, and brigade liaison detachment.

- The I/R detachment augments the I/R battalion and is aligned with the operation of a 1,000-person EPW enclosure or a facility for 2,000 DCs.
- The TDRC collects, processes, and disseminates information regarding detainees to authorized agencies. Although typically operating at the theater level, the TDRC may be directly linked to the TIF to facilitate accounting. It is a modular organization that is capable of breaking down into four separate teams to be deployed in support of smaller contingency operations at the team level.
- The camp liaison detachment/brigade liaison detachment maintains continuous accountability of detainees captured by U.S. armed forces that have been transferred to the control of HN or multinational forces. The camp liaison detachment/brigade liaison detachment monitors the custody and care of U.S.-captured prisoners that are being interned by HN or multinational forces according to the Geneva Conventions.

MILITARY WORKING DOGS

3-33. MWDs offer a psychological and actual deterrent against physical threats presented by I/R populations. (See FM 3-19.17.) They may be used—

- To reinforce exterior security measures against penetration and attack by small enemy forces.
- As patrol dogs to track escaped prisoners.
- As perimeter security patrols.
- For narcotic and/or explosives detection.
- To deter escapes during external work details.

3-34. MWD employment compliance and oversight capabilities typically exist at the MPC and military police brigade levels. Responsibilities, to include those for kennel masters, should be embedded within those organizations to ensure that proper mission-oriented taskings for MWDs are implemented.

3-35. At the battalion level, the MWD program provides the capabilities of two patrol explosive detection dogs and one patrol narcotic detection dog. These MWDs are normally employed exclusively at the TIF/SIF levels.

WARNING

MWDs, contracted dogs, or any other dog in use by a government agency will not be used to guard detainees, U.S. military prisoners, or DCs. Additionally, dogs may not be used as part of an interrogation approach, nor to harass, intimidate, threaten, or coerce a detainee for interrogation purposes.

STAFF DUTIES AND RESPONSIBILITIES IN SUPPORT OF INTERNMENT AND RESETTLEMENT

3-36. The staff primary function is to help commanders exercise control over all aspects of operations and sustainment. Control allows commanders to direct the execution of operations. The staff officers/sections described in the following paragraphs are especially critical in detainee operations. (See FM 6-0.)

PROVOST MARSHAL

3-37. The PM advises the CDO and/or commanders on military police capabilities, programs, and policies. The PM coordinates daily with the commander and staff officers on the employment of military police assets and support, ensures that military police planning is practical and flexible, and ensures that plans reflect manpower and resources that the military police require. The PM advises the CDO on the C2 relationship of military police and support assets. When required, the PM coordinates with the movement control officer for transportation assets to evacuate detainees, U.S. military prisoners, and/or DCs.

OPERATIONS OFFICER

3-38. The operations officer is responsible for planning, organizing, directing, supervising, training, coordinating, and reporting activities when conducting operations involving detainees, U.S. military prisoners, or DCs. The roles and responsibilities of the operations officer may include, but are not limited to—

- Planning and directing military police activities required for I/R operations.
- Recommending task organization and assigning missions to subordinate elements.
- Maintaining detainee accountability and the detainee automated personnel database.
- Coordinating detainee evacuation and transportation requirements.
- Transferring detainees to civilian authorities.

INTELLIGENCE OFFICER

3-39. The intelligence officer advises the commander on matters pertaining to MI, operations, and training at all echelons where detainee operations are likely to occur. The intelligence officer produces and disseminates intelligence products throughout the chain of command.

3-40. Intelligence requirements include specific information that the commander requires to maintain the continued control of detainees and those items of information requested by higher headquarters and other agencies. The intelligence officer prepares priority intelligence requirements in coordination with the

multinational force HUMINT and multinational force human intelligence and counterintelligence staff element (C-2X) J-2X section, and other interested agencies. The CDO does not establish interrogation priorities, but will work with the detainee operations staff and higher headquarters to resolve issues in implementing the interrogation plan according to the approved theater Army standards for interrogations. The JIDC is responsible for coordinating intelligence requirements to maintain a constant flow of useful intelligence for the joint force commander. The JIDC must have unfettered access to the C-2X/J-2X to synchronize HUMINT and counterintelligence collection priorities on the collection of actionable intelligence.

3-41. Intelligence representatives from the G-2X, J-2X, and/or C-2X will be attached to the CDO staff. The human intelligence and counterintelligence operations manager or staff section representatives will advise the CDO on all HUMINT and counterintelligence policy and operations.

MEDICAL SECTION

3-42. The I/R battalion and brigade are staffed with medical sections, to include preventive medicine. (See appendix I.) The medical personnel section is responsible for the health service support of the command and I/R populations within the I/R facility. This section advises the commander and the commander's staff, plans and directs Level 1 health care, and arranges for Level 2 and Level 3 (including air/ground medical evacuation and hospitalization) when required. It provides for the prevention of disease through the preventive medicine programs. The medical section consists of—

- The medical treatment squad provides routine medical care (sick call) and advanced trauma management for detainees. U.S. medical personnel supervise qualified RP who are providing medical care for detainees. This squad performs initial medical exams to determine the physical fitness of arriving detainees as stipulated by the Geneva Conventions. It has the capability to operate as two separate treatment teams.
- The preventive medicine section, which provides limited preventive medicine services for the facility. This section performs sanitary inspections of housing, food service operations, water supplies, waste disposal operations, and other operations that may present a medical nuisance or health hazard to personnel. It provides training and guidance on all aspects of preventive medicine to the staff, unit personnel, and others involved in the operation.

STAFF JUDGE ADVOCATE

3-43. The SJA provides operational law advice and support for I/R operations (particularly the interpretation of the Geneva Conventions), to include the application of force in quelling riots and other disturbances. The SJA also provides advice and support in any investigation that is required following the death or injury of a detainee during internment. In addition, the SJA serves as the recorder for Article 5 tribunals, which determine the status of individuals who have been detained. There is no requirement that the detainee commit a hostile act before being entitled to a tribunal. A tribunal may be established to determine the status of an individual because of complaints and/or inquiries received from the protecting powers or the ICRC. The SJA serves as the commander's liaison to the ICRC and provides legal advice to the commander on—

- Military justice.
- Administrative and civil laws.
- Contracts and fiscal laws.
- International and operational laws.
- Legal assistance.
- Claims.

3-44. The SJA provides technical advice and assistance pertaining to detainee labor policy as it relates to supporting local indigenous requirements that do not directly advance the war effort. The SJA ensures that the policy complies with all treaties and conventions.

HUMAN RESOURCE OFFICER

3-45. The human resource officer is the staff officer responsible for advising the commander on human resource support to the organization. Human resource support includes manning the force (personnel accountability, personnel readiness management, strength reporting and personnel information management), providing human resource support (postal and essential personnel services), coordinating personnel support (morale, warfare, recreation, and command programs), and conducting human resource planning and operations. The human resource officer is responsible for maintaining personnel records of U.S. military prisoners, providing mail operations to detainees and, by exception, assist in mail support to DCs. The human resource officer may also be tasked with coordinating the tracking and accountability of DCs, providing limited administrative support for U.S. military prisoners, and preparing documents for court-martial charges for detainees and U.S. military prisoners. Each I/R battalion has a personnel and administration section, which is capable of inprocessing eight individuals per hour (depending on the category).

FINANCE AND ACCOUNTING OFFICER

3-46. The finance and accounting officer accounts for impounded financial assets (cash and other negotiable instruments) of applicable detainees. (See DFAS-IN Regulation 37-1 and FM 1-06.) An I/R finance section is found in each I/R battalion. Finance personnel coordinate with the supporting finance unit to record pay and/or labor credits, canteen purchases and/or coupons issued, and other transactions. They coordinate for payroll, disbursement, and repatriation settlement processing. The finance section chief advises the commander on finance and accounting issues.

CIVIL-MILITARY OPERATIONS OFFICER

3-47. The civil-military operations officer—

- Provides technical advice and assistance in community relations and information strategies.
- Plans positive, continuous community relations programs to gain and maintain public understanding, goodwill, and support for military operations.
- Acts as the liaison and coordinates with other U.S. government agencies; HN civil and military authorities concerned with I/R operations; and NGOs, IOs, and international humanitarian organizations in the AO.
- Coordinates with the SJA concerning advice given to commanders about RUF when dealing with detainees.
- Provides technical advice and assistance in the reorientation of enemy defectors or detainees.

CHAPLAIN OR UNIT MINISTRY TEAM

3-48. The chaplain or unit ministry team assists the commander in providing religious support for I/R operations. The chaplain or team—

- Serves as the chaplain for detention facility personnel, which does not include detainees.
- Advises the commander on detainee religious issues and support.
- Serves as a moral and ethical advisor to the detention facility commander.
- Exercises supervision and control over RP religious leaders within the facility.
- Is prohibited from privileged communications with detainees.
- Acts as a liaison with clerical personnel who are supporting rehabilitative religious programs.

ENGINEER OFFICER

3-49. The engineer officer can assist in planning and implementing infrastructure design and improvement at all echelons where I/R operations occur. The support necessary for horizontal and vertical construction support, repair and maintenance of the infrastructure that supports I/R operations, and other necessary support is coordinated through the engineer officer. The engineer officer may coordinate for the training of detainees for internal and external labor requirements that involve construction or repair of facilities, but

this will require military police support to control and supervise the detainees. With proper planning and resourcing, the engineer officer can coordinate—

- Construction support for facilities.
- Construction, acquisition, maintenance, and repairs of semipermanent and permanent utilities, water supply system, sewage system, and portable or fixed electric power utilities.
- Fire protection measures for facilities.

PUBLIC AFFAIRS OFFICER

3-50. The public affairs officer understands and fulfills the information needs of Soldiers, the Army community, and the public in matters related to I/R operations. In the interest of national security and the protection of detainees from public curiosity, detainees will not be photographed or interviewed by the news media. The public affairs officer—

- Serves as the command spokesperson for communication with external media.
- Facilitates media efforts to cover operations by expediting the flow of complete, accurate, and timely information.

SIGNAL OFFICER

3-51. The signal officer is responsible for matters concerning signal operations, automation management, network management, and information security. The signal officer is typically located at the military police brigade.

MOVEMENT CONTROL OFFICER

3-52. The movement control officer plans and coordinates the movement of detainees, U.S. military prisoners, and DCs and their property with the movement control center and coordinates with brigade operations for the daily transportation requirements for the evacuation and transfer of the I/R population. This includes determining the transportation requirements for the evacuation of the I/R population from one level of internment to the next and coordinating arrangements.

INSPECTOR GENERAL

3-53. The inspector general section—

- Advises I/R commanders and staffs.
- Conducts assessments, surveys, and studies to comply with international, state, and U.S. laws.
- Receives allegations and conducts investigations and inquiries based on reports and information obtained from the I/R population, U.S. armed forces, and/or multinational guard and police forces.
- Consults with international and U.S. agencies in matters pertaining to the overall health and welfare of detainees, U.S. military prisoners, and DCs.
- Determines the military police unit's discipline, efficiency, morale, training, and readiness and provides feedback to the chain of command.
- Resolves complaints made by detainees, U.S. military prisoners, DCs, and U.S. armed forces personnel in a manner that is consistent with military necessity.
- Identifies negative trends to correct and improve I/R operations that are according to doctrine, military laws, international laws, UN mandates, and foreign national laws.
- Assists in the resolution of systemic issues pertaining to the processing and administration of the protected population.

3-54. The inspector general section reports war crime allegations from detainees or U.S. military prisoners, upon receipt, through the chain of command to the SJA or the U.S. Army Criminal Investigation Command. The inspector general does not investigate war crimes. Primary investigative responsibility for

alleged war crimes belongs to the U.S. Army Criminal Investigation Command. The SJA provides the U.S. Army Criminal Investigation Command with legal advice during war crime investigations.

PSYCHOLOGICAL OPERATIONS OFFICER

3-55. The PSYOP officer in charge of supporting I/R operations serves as the special staff officer responsible for PSYOP. The PSYOP officer advises the military police commander on the psychological impact of military police or MI actions to prevent misunderstandings and disturbances by detainees and DCs. The supporting I/R PSYOP team has two missions that reduce the need to divert military police assets to maintain security in the I/R facility. (See appendix J.) The team—

- Assists the military police force in controlling detainees and DCs.
- Introduces detainees or DCs to U.S. and multinational policy.

3-56. The PSYOP team also supports the military police custodial mission in the I/R facility. The team—

- Develops PSYOP products that are designed to pacify and acclimate detainees or DCs to accept U.S. I/R facility authority and regulations.
- Gains the cooperation of detainees or DCs to reduce the number of guards needed.
- Identifies malcontents, trained agitators, and political leaders within the facility who may try to organize resistance or create disturbances.
- Develops and executes indoctrination programs to reduce or remove antagonistic attitudes.
- Identifies political activists.
- Provides loudspeaker support (such as administrative announcements and facility instructions when necessary).
- Helps the military police commander control detainee and DC populations during emergencies.
- Plans and executes a PSYOP program that produces an understanding and appreciation of U.S. policies and actions.

Note. PSYOP personnel use comprehensive information, reorientation, and educational and vocational programs to prepare detainees and DCs for repatriation.

3-57. The PSYOP officer is an integral part of the I/R structure. The PSYOP officer often may work in close conjunction with the behavioral science consultation team, if available, for behavioral assessments and recommendations. The behavioral science consultation team may develop behavioral management plans and perform many other functions to assist the PSYOP officer if directed. The I/R facility commander may designate a location in which PSYOP personnel can conduct interviews of the various categories of people associated with I/R. This location must be separate and away from the interrogation areas.

CIVIL AFFAIRS PERSONNEL

3-58. CA personnel primarily support civil-military operations. (See chapters 2 and 6.) They conduct DC operations in support of I/R across the spectrum of operations. Other related activities that they conduct include—

- Population and resource control.
- Foreign internal defense.
- Humanitarian assistance.
- Unconventional warfare.

COUNTERINTELLIGENCE AGENTS

3-59. Counterintelligence agents may be attached or in direct support of a mission to an I/R battalion or military police brigade to assist the facility commander with intelligence requirements for the facility and surrounding area and to ensure the safety and security of personnel operating in and around the facility.

Note. Counterintelligence agents may serve as a central repository for information and intelligence on safety and security issues related to the facility.

- 3-60. Such responsibilities may include—
- Identification of detainee agitators, leaders, and their followers.
 - Identification of existing clandestine detainee organizations, to include—
 - Strength.
 - Objectives.
 - Member identity.
 - Identification of existing underground communications systems—
 - Between compounds and internment facilities.
 - With indigenous civilian personnel.
 - For overt attempts by detainees or local indigenous people to communicate with each other.
 - Identification of suspicious activities by local people near the internment facility (such as photographing or sketching the facility).
 - Identification of the existence of fabricated weapons, stores of food, and supplies of clothing in the compound.
 - Identification of plans by detainees to conduct demonstrations, to include—
 - Date and time.
 - Number of detainees involved, by compound.
 - Nature of the planned demonstration (passive, harassing, or violent).
 - Identification of detainee objectives, propaganda, and attempts to weaken or test internment facility authority and security, establish control in individual compounds, and orchestrate mass escapes.

LOGISTICS OFFICER

3-61. The logistics officer is responsible for the acquisition, storage, movement, distribution, maintenance, evacuation, and disposition of all classes of supplies and materiel. Additionally, the logistics officer (in the absence of an engineer officer) must provide staff oversight to ensure acquisition, construction, maintenance, operation, and disposition of facilities.

SUBSISTENCE/FOOD SERVICE OFFICER

3-62. The subsistence/food service officer directs activities related to field feeding. He/she inspects survey operations, advises on regulatory requirements, prepares instructions, and provides technical guidance for subordinate elements. He/she also assists in the supervision of Class 1 activities for detainees and DCs.

INTERAGENCY REPRESENTATIVE

3-63. The interagency representative coordinates visits with the CDO. Additionally, the interagency representative coordinates with the detention facility commander and JIDC commander before in any interview or interrogation.

MULTINATIONAL REPRESENTATIVE

3-64. The multinational representative coordinates visits, to include inspections of conditions for detainees captured by their forces and coordinating with the detention facility commander and JIDC commander before they participate in interviews or interrogations.

GUARD FORCE

3-65. The guard force provides external and internal security of the facility. A guard force at an I/R facility is tailored to the size and duration of the particular mission. The guard force may consist of a commander of the guard, one or more sergeants of the guard, a relief commander for each shift, and the necessary number of guards. Orders for guards are as follows:

- General orders apply to all guards. Guards are required to know, understand, and comply with the general orders in FM 22-6.
- Special orders apply to particular posts and duties. These orders supplement general orders, are established by the commander, and may differ for various guard posts. Special orders may be written for close contact guards, interview room guards, hospital guards, main gate/sally port guards, quick-reaction force guards, tower/perimeter guards, or walking patrol guards.

3-66. The guard force is the primary source for the security of I/R populations and must have adequate weapons systems, transportation, communication, and night vision equipment to accomplish their mission. The guard force—

- Performs internal guard duties.
- Guards sally ports (a series of gates opening and exiting from an enclosed area) and main gates.
- Conducts searches.
- Receives and processes detainees, U.S. military prisoners, and DCs.
- Performs escort duties.
- Guards facility gates.
- Performs external guard duties.
- Performs tower guard duties.
- Guards transfer areas.
- Guards work sites.
- Guards perimeters.
- Maintains custody and control within detainee populations.
- Responds to emergencies according to emergency action plans and contingencies.
- Conducts inspections, searches, head counts, roll calls, and bed checks according to the SOP.
- Maintains custody and control of detainees who may be segregated from the general population due to inprocessing, administrative, or disciplinary reasons.
- Annotates required checks, visits, and other procedures as directed by the SOP.

3-67. The guard force shift supervisor is responsible for the guard force. The shift supervisor—

- Supervises custodial personnel.
- Is responsible for the activities of I/R populations during the tour of duty.
- Monitors custody, control, and security measures.
- Ensures compliance with the daily operations plan for general and close detention.
- Initiates emergency control measures.
- Maintains DA Form 1594 (*Daily Staff Journal or Duty Officer's Log*).
- Handles situations dealing with the I/R population in the absence of the commander.
- Maintains a portion of the detainee accountability database.

Chapter 4

Capture, Initial Detention, and Screening

Personnel conducting detainee operations must ensure that these operations are performed in a manner that provides for the humane treatment and care of detainees, thereby reducing the probability of incidents of abuse involving U.S. armed forces and detainees. All detainees will be treated according to the GPW and GC unless directed otherwise by competent authority. The presumptive status of a detainee (until determined otherwise by a tribunal or combatant commander guidance) from the POC to the detention facility is EPW. The professional execution of the I/R function is critical in sustaining goodwill among the indigenous population. While not directly translatable to dealing with DCs, the basic framework of detainee capture, initial detention, and screening has applicability in resettlement operations.

DETAINEE FLOW

4-1. Detainee operations are the range of actions taken by U.S. armed forces, beginning at the POC; through movement to a DCP, DHA, or fixed internment facility, until their transfer, release, or repatriation. All Soldiers participating in military operations must be prepared to process detainees. Actions at the POC—the point at which a Soldier has custody of, and is responsible for safeguarding, a detainee—can directly affect the mission success and could have a lasting impact on U.S. strategic military objectives.

4-2. The number of detainees captured by U.S. armed forces at any given point can range from one to hundreds, depending on the scope of the operation and the elements involved. While one or two detainees may not create a major challenge, a large number of detainees require significantly more Soldiers and resources and pose increased security risks to Soldiers and themselves. Detainees must be safeguarded, to include provisions for adequate space, food, and waste disposal. These tasks are manpower-intensive and can cause significant delays in onward movement and divert unit assets from the primary mission.

4-3. Military police are responsible for receiving, securing, processing, and interning detainees and operating a DCP, DHA, TIF, and SIF. Detainees are normally evacuated from the POC to a DCP, DHA, or TIF; however, this flow may be modified to meet intelligence collection and medical treatment requirements. For example, an injured detainee may be evacuated to any medical treatment facility, including one at a higher echelon internment facility if required to provide proper medical treatment. Likewise, a detainee may bypass one or more of the normal detainee flow steps if necessary to support intelligence collection. There may be situations where interests are legitimately in conflict. For example, a detainee may need to be expedited to the JIDC for proper interrogation, but the operational situation may preclude such evacuation. Conflicts between competing interests that cannot be resolved at subordinate levels will be raised to the common higher headquarters for resolution in an expeditious manner. There are numerous points at which decisions must be made at various echelons to retain or release a detainee. These decision points are the POC, DCP, DHA, and TIF. When operational circumstances dictate, a DCP or DHA may be bypassed, and the detainees may be delivered directly to a TIF. Detainees should not be brought directly to a TIF/SIF. Detainees should be initially processed at the lowest level that is operationally feasible to maximize the timely receipt of critical tactical intelligence. Figure 4-1, page 4-2, illustrates this discussion. Guards are required when accompanying wounded detainees and medical personnel to an medical treatment facility.

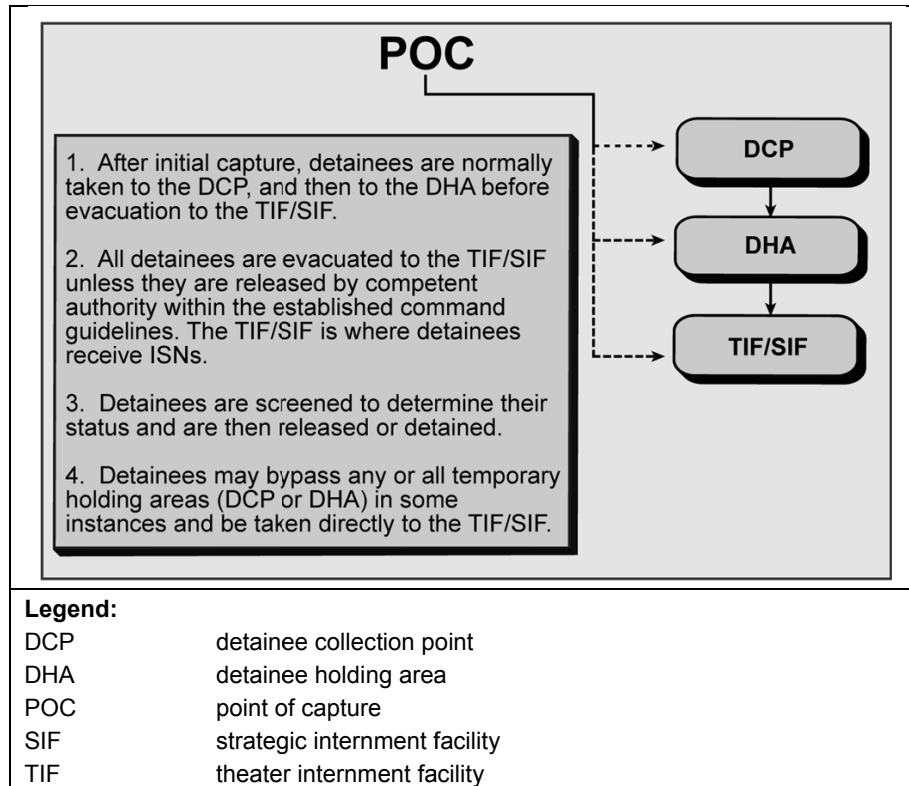

Figure 4-1. Detainee flow

Note. All personnel, including those from other government agencies, must adhere to DOD practices and procedures when conducting detention or interrogation operations within DOD facilities.

BRIGADE COMBAT TEAM AND BELOW

4-4. Detainee operations begin at the BCT or armored cavalry regiment level. At the POC, the person responsible for detainee operations might be a team or squad leader. The senior member of the capturing unit is responsible for ensuring the humane treatment and proper handling of detainees. The capturing unit evacuates detainees to the DCP when transportation is available. This evacuation is conducted to reduce the threat to detainees associated with any ongoing conflict or operation and to place them in a location where U.S. armed forces can fulfill legal and policy requirements for the treatment and administration of detainees. The capturing unit typically releases detainees to the custody of the military police operating the DCP. (See figure 4-2.) The military police platoon leader serves as the officer in charge for detainee operations at the DCP unless there are multiple DCPs and the requirements exceed the military police capability within the BCT (for example, during extended stability operations and high detainee capture rates typical during counterinsurgency operations). In instances where a military police platoon leader is not the officer in charge of a DCP, the BCT PM advises BCT and subordinate commanders, ensuring that technical oversight is exercised so that detainees are treated humanely and within the parameters of ARS and U.S. and international laws. High-value detainees are typically taken directly from the POC to the TIF. Wounded or injured detainees may need to be taken directly to a medical treatment facility.

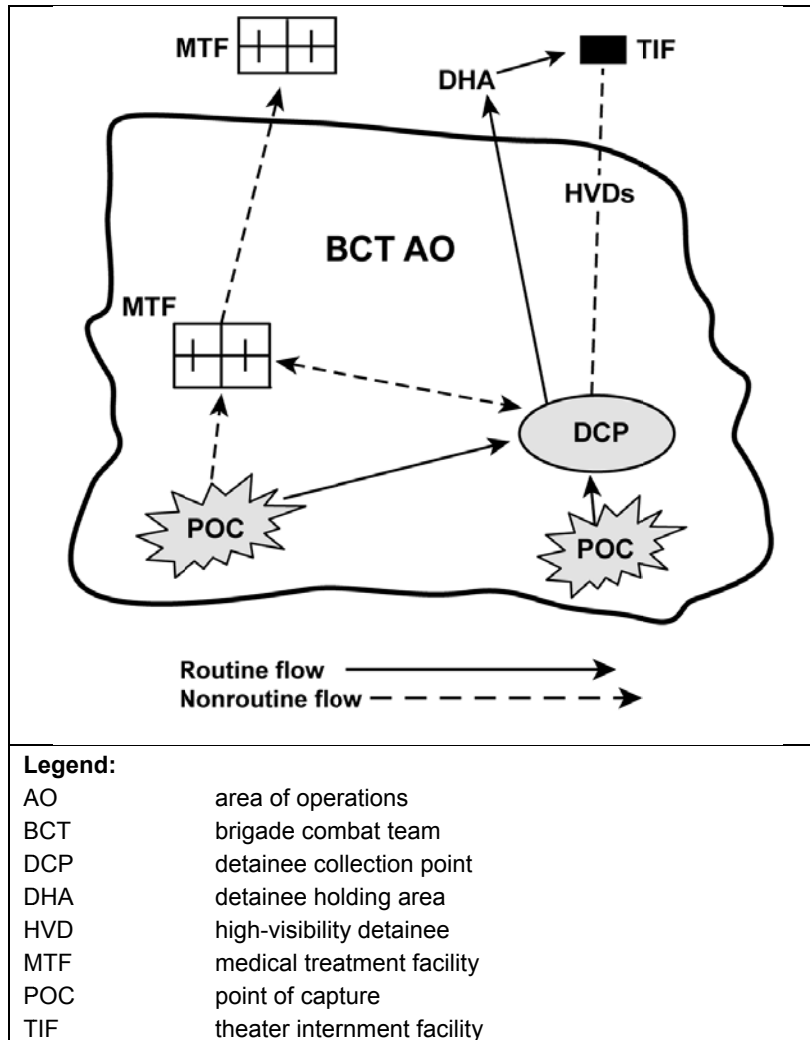

Figure 4-2. POC to TIF detainee flow

4-5. The DCP is austere. It may be relocated based on operational needs and normally consists of detention, interrogation, and medical operations. The military police platoon that is organic to the brigade special troops battalion or any other military police platoon task-organized to the unit operates the DCP. Military police personnel at the DCP coordinate and synchronize efforts with the various units with the BCT. These efforts may range from ensuring proper medical support at the DCP to engineer support in building and sustaining the DCP.

4-6. The military police platoon leader exercises control over all personnel and units while they are within the DCP. The military police platoon ensures that intelligence and medical operations are conducted according to U.S. policy regarding humane treatment. In addition, the military police platoon maintains custody and control of detainees. This responsibility includes overseeing joint, interagency, and multinational personnel conducting intelligence and medical operations within the DCP.

4-7. Soldiers who provide medical support or conduct interrogation operations may not be present at all times. The medical elements from the medical company of the support battalion and the interrogation elements from the MI company of the brigade special troops battalion come and go as the mission dictates. The MI commander is responsible for conducting interrogations, coordinating with the HUMINT and counterintelligence staff officer (S-2X) for the control of interrogations and other intelligence operations, ensuring the proper use of doctrinal approaches and techniques, and providing the control of interrogation activities through technical channels. The medical unit is responsible for conducting medical activities

within the DCP and establishing priorities over those activities. The units incorporate technical direction from higher headquarters to ensure adherence to applicable U.S. laws and regulations, international laws, execution orders, FRAGOs, and other operationally specific guidelines.

4-8. The BCT PM serves as the technical advisor on detainee operations for the BCT or subordinate commander and military police platoon leaders. The BCT coordinates for the transportation and security of detainees to the DHA. Detainee evacuation depends on the availability of transportation and the completion of time-sensitive MI exploitation. The BCT PM and logistics staff officer (S-4) coordinate transportation with the supporting sustainment brigade and coordinate military police escort with the MEB or higher headquarters.

Note. The standards used to process detainees at the DCP are the same as those for the DHA.

DIVISION ECHELON

4-9. While larger than a DCP, the DHA is also a temporary tactical holding area. Under rare circumstances, a DHA may be moved based on operational needs. At the division level, a military police company from a military police battalion, typically assigned or attached to the division MEB, normally operates the DHA within the division AO. When an MEB is not assigned to the division, a military police company assigned to a higher echelon military police battalion/brigade may operate the DHA. The senior military police commander, in coordination with the division PM and G-2, advises the division commander on detainee operations and recommends local policy and procedures for the division commander's approval and publication. The PM at each echelon and military police command structure provides technical guidance, through established technical channels, to military police units conducting detainee operations as directed by the CDO.

4-10. In some instances, a DHA may be established within a BCT AO. In this case the BCT organic military police platoon may be tasked to supplement the operation of the DHA. Depending on the tactical situation and availability of military police, nonmilitary police units may be tasked to operate the DHA. The division PM must advise the division commander and subordinate PMs to ensure that technical oversight is exercised and that detainees are treated humanely and within the parameters of ARs, U.S. and international laws. The division PM, SJA, and G-2 advise the division commander on all aspects of detainee operations and recommend local policy and procedures for the division commander's approval and publication. The PM provides technical guidance to units conducting detainee operations.

4-11. The military police company commander who is assigned the DHA mission serves as the DHA commander and exercises tactical control over personnel and units not assigned while they are operating within the DHA. The DHA commander ensures the humane treatment, evacuation, custody, and control (reception, processing, administration, internment, and safety) of detainees; protection measures; and the operation of the internment facility. Units typically operating within the DHA include medical elements from the medical support command supporting the division and MI elements from the battlefield surveillance brigade, MI battalion. The MI unit is responsible for conducting interrogations. It also prioritizes effort (through technical direction from higher headquarters), conducts other intelligence operations, ensures the proper use of doctrinal approaches and techniques, and provides technical guidance for interrogation activities. The medical unit is responsible for conducting medical activities within the DCP and establishing priorities over those activities. The unit provides technical authority over those activities to ensure adherence to applicable U.S. laws and regulations, international laws, execution orders, FRAGOs, and other operationally specific guidelines. Once transportation is available and MI personnel have completed interrogating detainees at the division level, the detainees are evacuated to the TIF.

ECHELONS ABOVE DIVISION

4-12. The theater level will typically include one or more TIFs that are centrally or regionally located. The military police commander who is designated as the CDO varies, depending on the number of TIFs in an operation area (OA), the size of the TIFs, the number of detainees, the size of the units operating within the TIFs, and the complexity of the detainee operation. The number of TIFs is determined by the number of detainees. There are many possible task organizations for detainee operations at this level. However, two

basic scenarios provide the foundation situations. The scenarios are an OA with a single TIF or multiple small TIFs or an OA with multiple TIFs (one is large).

4-13. The TIF is normally operated by an I/R battalion. It is considered a semipermanent facility at the theater level. The units operating within and in support of the TIF are generally constant. The TIF commander exercises tactical control over units/elements operating within the TIF for the humane treatment, evacuation, custody, and control (reception, processing, administration, internment, and safety) of detainees; protection measures; and the operation of the internment facility. In an OA with a single TIF or multiple small TIFs, the military police brigade commander is typically designated as the CDO and may require augmentation to perform CDO functions.

Note. In some cases, another military police officer (brigade commander, deputy brigade commander) could serve as the TIF commander. A TIF commander will not normally also be designated as the CDO.

4-14. In an OA with multiple TIFs (one or more are large) where an MPC is present in the theater, the MPC commander is normally designated as the CDO. It may be appropriate to designate the military police brigade commander as the CDO if an MPC is not present or if the CDO is required to report directly to a joint force commander instead of an Army forces commander. Designating the MPC commander as CDO in this latter case would result in the MPC commander reporting to the joint force commander for detainee operations and to the Army forces commander for other military police operations, possibly degrading the unity of command.

4-15. In both cases, the primary units operating in the TIF are an I/R battalion assigned to a military police brigade, all or a portion of an MI battalion organic to a theater intelligence brigade, and a medical element (perhaps a medical treatment facility). Units and personnel not assigned to the I/R battalion are under the tactical control of the TIF commander for the humane treatment, evacuation, custody, and control (reception, processing, administration, internment, and safety) of detainees; protection measures; and the operation of the internment facility while operating in the TIF.

4-16. The MI unit is responsible for conducting interrogations, prioritizing the interrogation effort through technical direction from its intelligence chain, and conducting other intelligence operations to ensure the proper use of doctrinal approaches and techniques and for providing technical guidance for interrogation activities. The medical unit is responsible for conducting all medical activities within the DCP and establishing priorities over those activities. The units maintain technical authority over those activities to ensure adherence to applicable U.S. laws and regulations, international laws, execution orders, FRAGOs, and other operationally specific guidelines.

DETAINEE PROCESSING

4-17. Detainee processing begins when U.S. armed forces capture an individual. It is accomplished at the POC for security, control, intelligence, and the welfare of detainees while in evacuation channels. All detainee processing must be accomplished with care to collect critical intelligence effectively, preserve evidence, maintain accountability, and protect detainees from danger or harm.

4-18. Detainee processing starts at the POC, continues at the DCP and DHA, and is completed at the TIF. Each subsequent location builds on processing completed at the previous location until the detainee is fully processed. Table 4-1, page 4-6, depicts the functions that are essential to performing detainee processing across the spectrum of operations, from the POC to the TIF or until the detainee is released.

Table 4-1. Detainee operations functional overview

POC	DCP	DHA	TIF	SIF
<ul style="list-style-type: none"> Process the detainee according to the "5 Ss and T" technique and return the detainee's protective equipment. Restrain/control the detainee. Establish and maintain accountability. <ul style="list-style-type: none"> Remove weapons and equipment from the detainee, and annotate them on DD Form 2745. Remove the detainee's personal items, and annotate them on DA Form 4137 (Evidence/Property Custody Document) if circumstances permit. <ul style="list-style-type: none"> Identify items of possible intelligence value. <ul style="list-style-type: none"> Record event circumstances (DA Form 2823 [Sworn Statement] is recommended). Move the detainee, using restraints. Report/investigate detainee abuse incidents. Provide first aid for wounds and injuries. Conduct initial screening. 	<ul style="list-style-type: none"> Handle the detainee using the search, tag, report, evaluate, segregate, and safeguard technique; and return the detainee's protective equipment. <ul style="list-style-type: none"> Transfer custody of the detainee using DD Form 2708. Maintain accountability. <ul style="list-style-type: none"> Transfer custody of evidence and personal property using DA Form 4137. Conduct an inventory of the detainee's property, and record it on DA Form 4137. Move the detainee while the detainee is restrained. Report/investigate detainee abuse incidents. <ul style="list-style-type: none"> Conduct a preliminary medical screening to identify, document, and treat wounds, injuries, and illnesses as appropriate. Perform a more detailed HUMINT/counterintelligence screening. Continue tactical interrogation, and start operational interrogation. Conduct an initial HUMINT/counterintelligence interrogation (if MI personnel are not present, conduct tactical questioning according to the CCIR). 	<p style="text-align: center;">Actions</p> <ul style="list-style-type: none"> Handle the detainee using the search, tag, report, evacuate segregate, and safeguard technique; and return the detainee's protective equipment. <ul style="list-style-type: none"> Transfer custody of the detainee using DD Form 2708. Maintain accountability. <ul style="list-style-type: none"> Transfer custody of evidence and personal property using DA Form 4137. Conduct an inventory of the detainee's property, and record it on DA Form 4137. Move the detainee while the detainee is restrained. Report/investigate detainee abuse. <ul style="list-style-type: none"> Conduct a preliminary medical screening to identify, document, and treat wounds, injuries, and illnesses as appropriate. Continue HUMINT/counterintelligence screening. Conduct a detailed MI interrogation. Continue tactical interrogation, and start operational interrogation. Evacuate or release the detainee. Continue categorization. Collect biometric information. Provide shelter and cover for the detainee. 	<ul style="list-style-type: none"> Handle the detainee using the search, tag, report, evacuate, segregate, and safeguard technique; and return the detainee's protective equipment. <ul style="list-style-type: none"> Transfer custody of the detainee using DD Form 2708. Maintain accountability. <ul style="list-style-type: none"> Transfer custody of evidence and personal property using DA Form 4137. Conduct an inventory of the detainee's property, and record it on DA Form 4137. Move the detainee while the detainee is restrained. Report/investigate detainee abuse incidents. <ul style="list-style-type: none"> Conduct a medical evaluation to identify, document, and treat wounds, injuries, and illnesses. Move or release the detainee. Confirm the detainee's category (use an Article 5 tribunal as necessary). Collect biometric information and enter data in the DRS. Issue the detainee an ISN, and enroll the detainee in the DRS. Report new detainees on DA Form 2674-R. Cross-reference the detainee's DD Form 2745 number with the detainee's ISN on all records. Provide enhanced shelter and cover for the detainee. Develop and maintain the detainee's medical records if not completed. Provide preventive care. <ul style="list-style-type: none"> Ensure that the facility meets cleanliness and sanitation standards. Provide for hygiene maintenance. Anticipate ICRC queries and visits. Use approved compliance techniques to ensure behavioral control. 	<ul style="list-style-type: none"> Handle the detainee using the search, tag, report, evacuate, segregate, and safeguard technique. <ul style="list-style-type: none"> Transfer custody of the detainee using DD Form 2708, and annotate the ISN. Maintain accountability. <ul style="list-style-type: none"> Transfer custody of evidence and personal property using DA Form 4137. Conduct an inventory of the detainee's property, and record it on DA Form 4137. Move the detainee while the detainee is restrained. Report/investigate detainee abuse. <ul style="list-style-type: none"> Conduct a medical evaluation to identify, document, and treat wounds, injuries, and illnesses. Initiate strategic interrogation. Evacuate or release the detainee. Formally inprocess the detainee to the internment facility using the DRS. Maintain biometric information in the DRS. Coordinate with the NDRC. Provide enhanced shelter and cover for the detainees. Report new detainees on DA Form 2674-R. Maintain the detainee's medical records if not completed. Provide preventive care. <ul style="list-style-type: none"> Ensure that the facility meets cleanliness and sanitation standards.

Table 4-1. Detainee operations functional overview (continued)

POC	DCP	DHA	TIF	SIF
Actions (continued)				
<ul style="list-style-type: none"> • Conduct an initial HUMINT/counterintelligence (if MI personnel are not present, conduct tactical questioning according to the CCIR. • Evacuate or release the detainee. 	<ul style="list-style-type: none"> • Evacuate or release the detainee. • Conduct initial categorization. • Collect biometric information on DD Form 2745 and, if desired, on supporting locally produced and approved forms. • Provide shelter and cover for the detainee. 	<ul style="list-style-type: none"> • Develop and maintain the detainee's medical records if not completed. • Provide preliminary preventive care as appropriate. • Provide for basic hygiene as appropriate. • Anticipate ICRC queries and visits. • Use approved compliance techniques to ensure behavioral control. • Provide dedicated security forces. 	<ul style="list-style-type: none"> • Develop and employ physical security and antiterrorism measures. • Anticipate media attention, and conduct media operations. 	<ul style="list-style-type: none"> • Anticipate ICRC queries and visits. • Use approved compliance techniques to ensure behavioral control. • Develop and employ physical security and antiterrorism and protection measures. • Anticipate media attention, and conduct media operations.
Organization				
Capturing unit.	Normally a military police platoon.	Normally a military police company.	Normally an I/R battalion.	Normally a military police brigade with joint assets.
<p>Legend: 5 S and T CCIR DA DCP DD DHA DRS HUMINT ICRC ISN MI NDRC POC SIF TIF</p>	search, silence, segregate, speed, safeguard, and tag commander's critical information requirements Department of the Army detainee collection point Department of Defense detainee housing area detainee reporting system human intelligence International Committee of the Red Cross internment serial number military intelligence National Detainee Reporting Center point of capture strategic internment facility theater internment facility			

4-19. Processing is not bound by a traditional linear-time model or specific time constraints. The model accommodates operational changes in current OEs. Detainees can be evacuated from any direction and point and from the POC to any DCP. They can also be evacuated directly to a DHA. Regardless of where they are evacuated from, they will continue to be processed until complete.

Note. Some functions performed at the POC (for example, search, accountability, and custody transfer) must be repeated as the detainee is processed from the POC through each subsequent level.

4-20. The goal is to efficiently move detainees through processing. However, at each point between the POC and TIF, leaders must make a deliberate decision whether to retain and evacuate detainees to the next level or release them. The decision to retain or release detainees must be made based on an assessment of the circumstances of the detainee's capture, their intelligence value, and/or evidence that they committed a crime and on additional direction from the chain of command. Each location may provide additional processing and screening criteria that should be included in the assessment and decision to retain or release.

POINT OF CAPTURE

4-21. Detainees pose significant operational risks that can hinder mission success in numerous ways. Most detainees are captured during a combat engagement and will most likely have weapons with unused ammunition and explosives. Detainees must be disarmed and secured to ensure that no further harm can be inflicted on them or U.S. armed forces. Noncompliant detainees require greater control measures that may become resource-intensive. It is critical that all Soldiers involved in combat operations receive training on detainee operations (to include detainee treatment) and procedures conducted at the POC.

4-22. Upon capturing detainees, Soldiers must monitor and control their emotions and monitor those of fellow Soldiers. Perhaps only moments earlier, these very detainees may have tried to kill, killed, or wounded fellow Soldiers. Soldiers must rely on the Army values and strictly adhere to U.S. military policy and the published ROE. Under no circumstances, can Soldiers allow themselves or others to retaliate or otherwise allow harm to befall detainees under U.S. armed forces control.

4-23. The POC represents the most vulnerable point at which Soldiers will process detainees. It often requires Soldiers to disarm, search, and guard detainees in an unsecured environment among other potential combatants, sympathizers, or counterinsurgents. Small units at the POC will probably not have enough resources and manpower to provide for a large number of detainees, but still must begin processing detainees while waiting for the arrival of additional resources and transportation. Here, leaders and Soldiers may have to assess the risks between providing security against potential attacks and other combatants or sympathizers in the area and providing enough security to control the detainees.

4-24. The POC is where most detainee abuse allegations occur; it is the point where emotions following enemy contact may run high and where there is a need to collect immediate intelligence information that may prevent additional casualties. Leaders and Soldiers must monitor unit and individual stress to prevent violations of U.S. military policy.

4-25. The POC is the first decision point at which a detainee will be released or transferred to the next echelon. Soldiers performing operations in which detainees are taken into custody should be aware of all considerations and requirements when making this decision. Once the decision is made, the information in table 4-2 should be applied.

Table 4-2. POC processing standards

Requirements	Actions
Search¹	Search and inspect detainees and their possessions, to include clothing, shoes, and headgear.
Inspect protective equipment	Inspect personal protective equipment. Once all items have been searched and deemed safe by U.S. and multinational forces, return them to the detainee. For this operation, protective gear such as helmets and CBRN protective clothing and equipment will remain with the individual.
Conduct property accountability	Document detainee property using DA Form 4137. Any property returned to the detainee must be signed for using DA Form 4137. Coordinate with interrogation/intelligence teams (if available) to determine which confiscated items have intelligence value. Personal items (diaries, letters from home, family pictures) may be taken by interrogation/intelligence teams for review.
Tag	Ensure that DA Form 2823, DA Form 4137, DD Form 2708, and DD Form 2745 are complete before detainees are evacuated. Enter the following information on DD Form 2745 (locally produced forms may be used to supplement, but do not replace, DD Form 2745): <ul style="list-style-type: none"> • Date and time of capture. • Capturing unit. • POC. • Circumstances of capture.
Report	Report the number of detainees by category and gender at each POC through appropriate command channels. This aids in determining transportation and security requirements.
Segregate	Ensure that detainees are segregated.
Safeguard	Provide first aid and medical treatment, as available, for wounded and sick detainees.
Evacuate²	Complete detainee processing. Once processing is complete, evacuate detainees from the POC through appropriate channels as humanely and quickly as possible.
Release³	Complete detainee processing. Once processing is complete, and if directed by appropriate command authority, release detainees as humanely and quickly as possible.
Notes:	
<p>¹Conduct same-gender searches when possible. If mixed-gender searches are necessary for speed or security, conduct them in a respectful manner and avoid any action that could be interpreted as sexual misconduct. To prevent allegations of sexual misconduct, the on-site commander/leader must provide appropriate supervision, with more mature and experienced personnel conducting mixed-gender searches.</p> <p>²Units designated to receive detainees at the DCP will prepare a DD Form 2708 (with a list containing each detainee's name attached) and provide a copy of the paperwork to the escort.</p> <p>³The decision to release an individual at the POC may be made by the senior-ranking person on the ground, based on command directives and guidance. Once a detainee is processed into a DCP or DHA the senior echelon commander holds release authority (typically, the battalion commander or brigade commander, respectively).</p>	
Legend:	
CBRN	chemical, biological, radiological, and nuclear
DA	Department of the Army
DCP	detainee collection point
DHA	detainee housing area
DD	Department of Defense
POC	point of contact

DETAINEE PROCESSING KIT

4-26. Detainee processing kits enable capturing units at the POC to properly secure; quickly, efficiently, and safely process; and quickly move detainees to the DHA away from the POC. The platoon leader will distribute necessary additional items or equipment based on mission requirements and mission variables.

4-27. At a minimum, a detainee processing kit should be maintained and contain the following items:

- Disposable restraints.
- Disposable restraint removers.
- Latex or vinyl search gloves.
- Plastic trash bags for detainee property.
- Plastic bags for evidence.
- Plastic document protectors for important papers.
- String, twine, or 550 cord.
- Duct, packing, or adhesive tape.
- Blindfold material.
- Unit SOP for handling and processing detainees and evidence.
- Visual language cards.
- Paper, envelopes, and tape (various sizes).
- Digital camera and video camera (with backup batteries).
- Explosive-residue detection kit.
- DD Forms 2708, DD Forms 2745, and any supporting locally approved and produced capture tags.
- Multilingual version of DA Forms 2823 and DA Forms 4137 as appropriate for the location.
- Colored, permanent markers and chalk.
- Event log (simple Microsoft® Office Word or Microsoft Office Excel document).
- Sketch pad (anything can suffice).
- Meal, ready to eat boxes, for documents/files.
- Voice recording device (optional).

Note. Units may add extra items as needed to the detainee processing kit based on mission variables.

TACTICAL UNIT PREPARATION

4-28. Critical operational planning considerations for the POC and detainee operations include the following:

- Ensure that operations are consistent with Army values and U.S. policy.
- Expedite detainee evacuation according to military necessity.
- Preserve, document, and control evidence and items that may be of intelligence value.
- Support tactical questioning and interrogation requirements.
- Deescalate events at the POC.
- Ensure that Soldiers are trained and rehearsed on the ROE and RUF.
- Prevent attempts to escape, disrupt operations, or harm U.S. armed forces.
- Provide adequate resources.

4-29. When planning tactical-level operations that may include capturing detainees—

- Plan for detainee processing regardless of the mission. Consider—
 - Using the latest intelligence for capture estimates.
 - Using detainee processing kits to process detainees at the POC.
 - Planning security to provide protection against external threats.

- Planning for transportation and resource requirements.
- Establishing DCPs and DHAs.
- Brief the Soldiers on the detainee mission. Consider—
 - Establishing search, security, and escort teams.
 - Ensuring that search team members (designated search personnel, guards, and interpreters) clearly understand their roles and responsibilities.
 - Reviewing the ROE and RUF and reinforcing the treatment of detainees according to military policy.
- Brief the Soldiers on how to reach a decision of detaining or releasing an individual. The current CCIR will assist in determining whether to detain. Other indicators to determine if an individual should be detained include—
 - The detainee shows hostility toward detention personnel.
 - The detainee dropped his weapon and attempted to escape.
 - There are physical differences in appearance between the detainee and other captured detainees.
 - There is a language difference between the detainees in the group (that reflects educational or regional differences within the group).
 - Multiple identification documents were found on the detainee.
- Rehearse detainee operations, from the POC to transfer or release. Consider having Soldiers rehearse—
 - Capture, search, security, and escort functions.
 - The ROE and RUF.
 - Scenarios that will build Soldiers' skills and confidence.

4-30. Leaders at the POC must review the circumstances of an individual's capture, the confiscated items, and the individual's intelligence and evidentiary value to provide a thorough assessment. Accordingly, sufficient information should be reported up the chain of command so they can make an informed decision on whether to retain or release the individual.

4-31. The capturing unit may perform tactical questioning. Tactical questioning is considered direct questioning (by DOD personnel) of a captured or detained person to obtain time-sensitive tactical intelligence (at or near the POC) that is consistent with applicable laws. Documentation of the event of capture is best transcribed on DA Form 2823; however, if time or circumstances do not permit, other means (note paper) may be used.

4-32. The military police platoon that is organic or task-organized to the BCT can provide the capturing unit with subject matter expert skills in collecting, processing, and evacuating detainees from immediate danger as soon as possible. Certain detainees with significant intelligence value could be required to remain close to the POC pending the exploitation of time-sensitive intelligence information by trained HUMINT and counterintelligence collectors.

DETAINEE PROCESSING TECHNIQUE

4-33. Upon capture, Soldiers must process detainees using the "search, silence, segregate, speed, safeguard, and tag (5 Ss and T)" technique. This technique provides a structure to guide Soldiers in conducting detainee operations until they transfer custody of detainees to another authority or location. Complete the "5 Ss and T" technique as follows:

- **Search.** Neutralize a detainee and confiscate weapons, personal items, and items of potential intelligence and/or evidentiary value.
- **Silence.** Prevent detainees from communicating with one another or making audible clamor such as chanting, singing, or praying. Silence uncooperative detainees by muffling them with a soft, clean cloth tied around their mouths and fastened at the backs of their heads. Do not use duct tape or other adhesives, place a cloth or other objects inside the mouth, or apply physical force to silence detainees.

- **Segregate.** Segregate detainees according to policy and SOPs (segregation requirements differ from operation to operation). The ability to segregate detainees may be limited by the availability of manpower and resources at the POC. At a minimum, try to segregate detainees by grade, gender, age (keeping adults from juveniles and small children with mothers), and security risk. MI and military police personnel can provide additional guidance and support in determining the appropriate segregation criteria.
- **Speed.** Quickly move detainees from the continuing risks associated with other combatants or sympathizers who may still be in the area of capture. If there are more detainees than the Soldiers can control, call for additional support, search the detainees, and hold them in place until reinforcements arrive.
- **Safeguard.** Protect detainees and ensure the custody and integrity of all confiscated items. Soldiers must safeguard detainees from combat risk, harm caused by other detainees, and improper treatment or care. Report all injuries. Correct and report violations of U.S. military policy that occur while safeguarding detainees. Acts and/or omissions that constitute inhumane treatment are violations of the law of war and, as such, must be corrected immediately. Simply reporting violations is insufficient. If a violation is ongoing, a Soldier has an obligation to stop the violation and report it.
- **Tag.** Ensure that each detainee is tagged using DD Form 2745. Confiscated equipment, personal items, and evidence will be linked to the detainee using the DD Form 2745 number. When a DA Form 4137 is used to document confiscated items, it will be linked to the detainee by annotating the DD Form 2745 control number on the form.

Note. Segregation is not intended to be used as an interrogation technique. (See FM 2-22.3.) In a detention facility, segregation should only be used for security reasons or to separate groups required to be grouped by the Geneva Conventions (grade, nationality, family).

4-34. To ensure accountability, each detainee is tagged by the capturing unit using DD Form 2745. Military police at DCPs and DHAs check each tag for—

- Date and time of capture.
- Capturing unit.
- POC.
- Circumstances of capture.

4-35. Decisions regarding a detainee's current and future status are based on the initial processing at the POC. Proper processing ensures that U.S. armed forces can take the appropriate action to release, detain, transfer custody, prosecute, or adjudicate detainees.

CUSTODY AND ACCOUNTABILITY OF PROPERTY, EVIDENCE, AND INTELLIGENCE INFORMATION

4-36. The accountability of detainees, detainee property, and items with evidentiary or intelligence value begins at the POC by documenting the information on DD Form 2745. Locally approved and produced forms may be used to supplement the DD Form 2745, but they do not replace the DD Form 2745. The DD Form 2745, and any supplemental forms are kept together with (preferably attached to) the detainee. The DD Form 2745 number is used to link the detainee to all confiscated property. The DD Form 2745 number is also used to link the detainee to other records such as property accountability forms, medical conditions, treatment records, interrogation data, and custody transfer records. The DD Form 2745 number is the only number used to account for a detainee and the detainee's property until an ISN is assigned at a TIF. DD Form 2745 is a permanent part of the detainee's record and the property custody and accountability system even after the detainee is issued an ISN.

Note. An ISN is normally issued as soon as possible, typically upon processing at a TIF/SIF, according to DOD policy.

4-37. DD Form 2745 is a three-part, perforated form with an individual serial number. It is constructed of durable, waterproof, tear-resistant material with reinforced eyeholes at the top of Parts A and C. Part A is attached to the detainee's clothing with wire, string, or another type of durable material. The capturing unit maintains Part B in its records. Part C is attached to the confiscated property so that the owner can be identified later.

4-38. Everything confiscated from a detainee (weapons, personal items, items of intelligence and/or evidentiary value) must be documented on DA Form 4137 and linked to the detainee by annotating the form with the DD Form 2745 number. Always transport the detainee and the confiscated items to ensure that both are available to MI personnel during screening and tactical interrogation. Further documentation, such as a photograph taken of the detainee and the detainee's property at the POC, allows for the increased ability to prosecute criminal detainees in courts of law. While photographs greatly enhance the possibility of future prosecution, they are only taken for official purposes and must be guarded from unauthorized use or release. (See AR 190-8.) If a detainee is suspected of committing, being involved in, or having knowledge of terrorist acts, crimes against humanity, war crimes, or other crimes, the PM and legal advisor must become involved with the case immediately. It is also imperative that an uncontaminated, unbroken chain of evidence be maintained to ensure a fair hearing if the detainee is brought to trial.

4-39. Proper and accurate documentation of the capture circumstances (DD 2745 and, if desired, a locally produced and approved supplemental form) provides information to support continued assessments on whether to detain or release the detainee; to make determinations on the detainee's status (CI, RP, or enemy combatant); to prepare for criminal proceedings; and/or to, ultimately, transfer custody of the detainee. Proper documentation also provides an official historic record of the events surrounding the capture of a detainee, which may prove invaluable to counter future false claims (such as the loss of personal property). Documentation initiates the chain of custody for evidence required to prosecute detainees who are suspected of committing crimes.

4-40. All Soldiers should possess the required detainee processing kit, which contains the items essential for the safe and proper processing of a detainee. The kit contains essential forms and expendable equipment to restrain a detainee and establish accountability for the detainee and their confiscated items. If time or the situation does not allow for the use of DA Form 4137 to document confiscated items, items are placed in the large resealable bag included in the detainee processing kit. The detainee's DD Form 2745 number is carefully marked on the bag using a permanent marker. The property inventory can then be transferred later to DA Form 4137 at the DCP.

RETAINED ITEMS

4-41. Retained items are items that detainees may keep during their captivity. (Initially, all items are confiscated.) Retained items are generally divided into two groups. The first group consists of items taken during the reception portion of inprocessing, and they may be returned later during processing. It contains, but is not limited to—

- Military mess equipment (except knives and forks).
- Helmets.
- CBRN protective suits and masks.
- Clothing.
- Badges of grade and nationality.
- Military decorations.
- Identification cards and tags.

4-42. The second group consists of items that detainees may keep at all times. It contains, but is not limited to—

- Religious literature (within reason).
- Personal items that have sentimental value (such as rings and pictures).

Note. Allow the detainees to retain their own rations in the early stages of detention.

CONFISCATED ITEMS

4-43. Confiscated items are weapons, ammunition, and military equipment other than those items allowed for personal protection. Medications in a detainee's possession are confiscated and placed in a plastic bag that is clearly marked. Medical personnel determine if detainees are permitted to retain their medication on their person for emergency treatment (such as an inhaler). All other medications are administered by medical personnel as required and/or directed. Some items (potential weapons, documents of intelligence value) should always be confiscated when searching detainees.

4-44. Military police coordinate with the MI HUMINT and counterintelligence collectors to determine which confiscated items are of evidentiary and/or intelligence value. Personal items such as diaries, letters from home, and family pictures may be taken by the MI teams for review but are later returned to the military police so that they can be returned to their owners. Items with evidentiary value must be marked (for example, engraved) in such a manner that the item can be positively linked to the detainee and to the supporting statements rendered by the detainee or witnesses of the suspected criminal activity. Evidence documented on DA 4137 must be transported to a centralized storage facility that has procedures in place regarding proper accountability, storage, and security until final disposition.

4-45. Per AR 190-8, currency is only confiscated on the order of a commissioned officer. DA Form 4137 is used as a receipt for currency. Confiscated currency may be impounded, retained as evidence of a crime, or retained for specific intelligence purposes. In any case, currency must be particularly safeguarded and promptly evacuated into appropriate security channels until final and proper disposition is determined.

4-46. Impounded items are not returned to detainees during detention because they make escape easier or compromise U.S. security interests. Items normally impounded are cameras, radios, and currency. (For a more in-depth discussion about confiscated and impounded property, see AR 190-8 and DFAS-IN 37-1.)

4-47. Property should be bundled or placed in bags to keep it intact and separated from other detainees' possessions. Accounting for property is not only important for returning items and preventing claims against the U.S. government, but also to link detainees to their property for intelligence exploitation. Property accountability is critical to possible criminal proceedings by the HN. Military police—

- Use DA Form 4137 as a receipt for confiscated and impounded property.
- Prepare DA Form 4137 for signature by the detainee and the receiver for any currency and/or negotiable items.
- List currency and negotiable items on DA Form 4137, but treat them as impounded property and possibly counterfeit material.
- Keep original receipts with the property during evacuation.
- Give detainees a copy of DA Form 4137 as a receipt for their property.
- Instruct detainees (in their own language, if possible) to keep the receipts to expedite the return of their property when they are released.
- Have MI personnel sign for property on DA Form 4137 and sign for detainees on DD Form 2708.
- Ensure that confiscated property is cleared by MI teams and returned to supply.
- Coordinate with the supported S-2X to ensure that items kept by MI personnel for intelligence value are forwarded through MI channels.

- Evacuate property retained by the detainee when the detainee is moved to the next detention level.
- Maintain controlled access to confiscated and impounded property.

DETAINEE MOVEMENT

4-48. When detainees have been processed and are ready for movement, leaders—

- Report detainee status through military police channels to the CDO.
- Request transportation, rations, and water from logistics channels.
- Ensure that DD Forms 2708 for detainees are ready for the escort guard's signature.
- Ensure that property taken from detainees for security or intelligence reasons is properly tagged and given to the guards who are moving the detainees to a DCP or DHA.

Note. All movements at or after the TIF are documented and executed using the Detainee Reporting System.

4-49. Prior to movement and when possible, detainees should be given clear, brief instructions in their own language. Military necessity may require delays in movement. When this occurs, ensure that there is an adequate food supply; potable water; and appropriate clothing, shelter, and medical attention available.

4-50. From the POC, detainees can be moved by a number of methods. Prior to movement ensure the detainees and transportation asset are searched for weapons or contraband. Develop a manifest for use as an official receipt of transfer and as a permanent record to ensure accountability of each detainee until release. The manifest should contain the following:

- Each detainee's—
 - Name, grade, and status.
 - DD Form 2745 control number.
 - Nationality and their power served.
 - Physical condition.
- The transport vehicle and destination.

4-51. Maintain control and accountability of detainees and their property until releases or transfers are received by the appropriate authorities. Joint inventories of pertinent documentation and confiscated items must be completed before any transfer or release. Confiscated items should be transported along with the detainee, annotated on a DA Form 4137, and identified by the DD Form 2745 control number. The DD Form 2745 control number should also be noted on the DA Form 4137. Strict accountability will be maintained throughout all movement.

4-52. Before movement, an interpreter should be used to brief detainees on—

- Actions to take upon hearing the word "Halt."
- The need to remain silent at all times.
- Actions to take during an emergency (such as a delay, crash, or enemy attack).
- Signals used to direct detainee movement.
- Responses to escape attempts according to the ROE and RUF.

4-53. Detainees should **not** be daisy-chained during transport. In addition, restraining detainees to fixed structures or objects while in transport is prohibited unless specifically approved by the facility commander.

Note. Restrained detainees will always be assisted on and off any mode of transportation to prevent injury.

METHODS OF TRANSPORTATION

FOOT

4-54. Movement by foot is the least preferred transportation method. It is often used, as necessary, to move detainees from the POC to the DCP. Distances do not normally exceed 5 miles. If movement by foot must occur, ensure that detainees are fully ambulatory and have appropriate footwear. Movement by foot is not used for uncooperative detainees.

WHEELED VEHICLE

4-55. Movement by vehicle is the most common and most reliable method of transporting detainees. If possible, avoid using team vehicles (such as high-mobility multipurpose wheeled vehicles). Conceal detainees inside wheeled vehicles by covering vehicle windows and other openings with tarps and window coverings when possible. Guards should always be placed to the rear of vehicles with open tops or backs. Conduct a search of the vehicle for potential weapons or contraband before loading detainees. Escort security vehicles should be considered for front, rear, and flank security.

BUS

4-56. During bus movement, planners should plan for two detainees per seat. (See figure 4-4.) Do not allow detainees to stand, sit, or lie on the floor. Lock doors from external threats. When multiple vehicles are used, escort security vehicles may also be necessary.

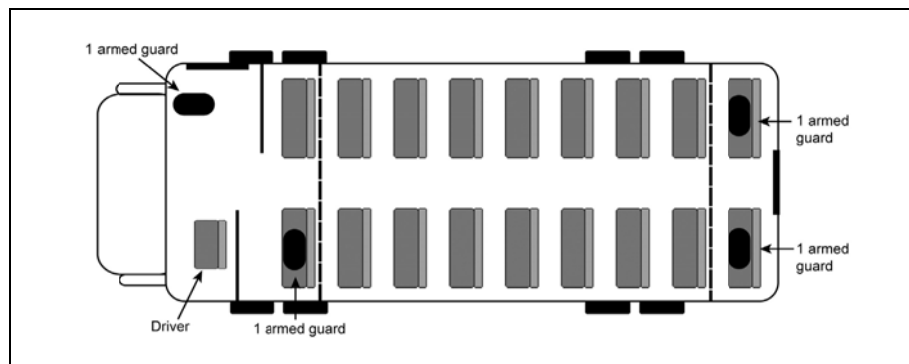

Figure 4-4. Movement by bus

CARGO TRUCK TRANSPORT

4-57. The use of tarp-covered vehicles is another method of transporting detainees. (See figure 4-5.) Tightly position detainees along the bench seat without restraining them to the bus infrastructure or other fixed objects. Soldiers should not allow detainees to stand, sit, or lie on the floor of the vehicle. When multiple cargo trucks are used, escort security vehicles may also be necessary.

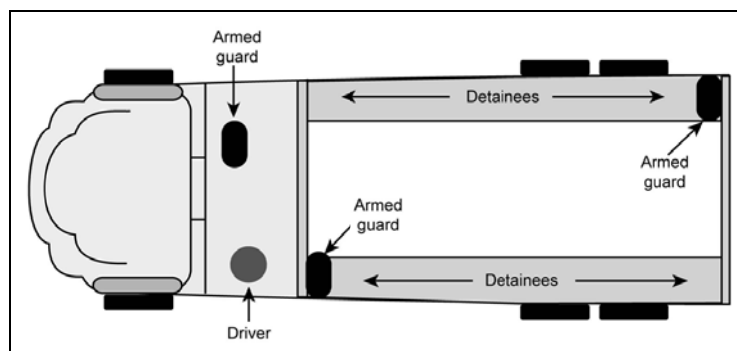

Figure 4-5. Movement by cargo truck

RAIL

4-58. Movement of detainees by rail is rare and only available in industrialized locations. (See figure 4-6.) The disadvantages to movement by rail are that trains are easily disrupted by improvised explosive devices, detainees require additional transportation to rail stations or other stopping points, and the mission is vulnerable at critical sites during transport. The preferred method of rail transportation is via passenger railcars.

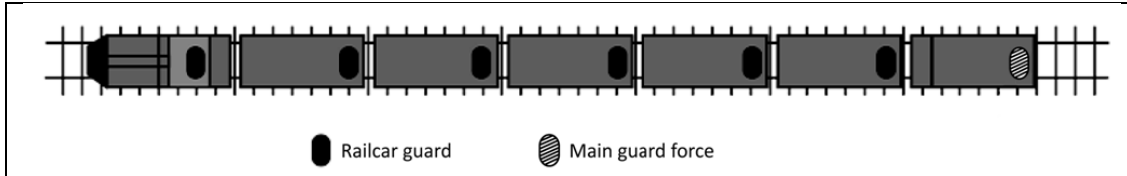

Figure 4-6. Movement by rail

4-59. During movement, position mobile security teams at critical urban crossing sites, bridge crossings, and at stations or other stopping points if possible. Conceal detainees using railcars and window coverings when possible, and always position guards at the rear of open-top railcars. Railcars should be thoroughly searched before boarding detainees, and detainees should never be restrained to the railcar infrastructure. Loading and seating arrangements are based on the size and configuration of railcars.

HELICOPTER

4-60. The critical planning factor to remember during air transport by helicopter is that the aircraft commander is in charge of that aircraft and will likely dictate how the transportation and security of detainees will be enforced. (See figure 4-7.) Some of the disadvantages to air movement are that it requires additional training and rehearsals, is weather-dependent, requires a higher guard-to-detainee ratio, and often entails different ROE. An advantage to air movement is the speed with which a detainee is moved off the battlefield.

Note. Do not use firearms aboard an aircraft.

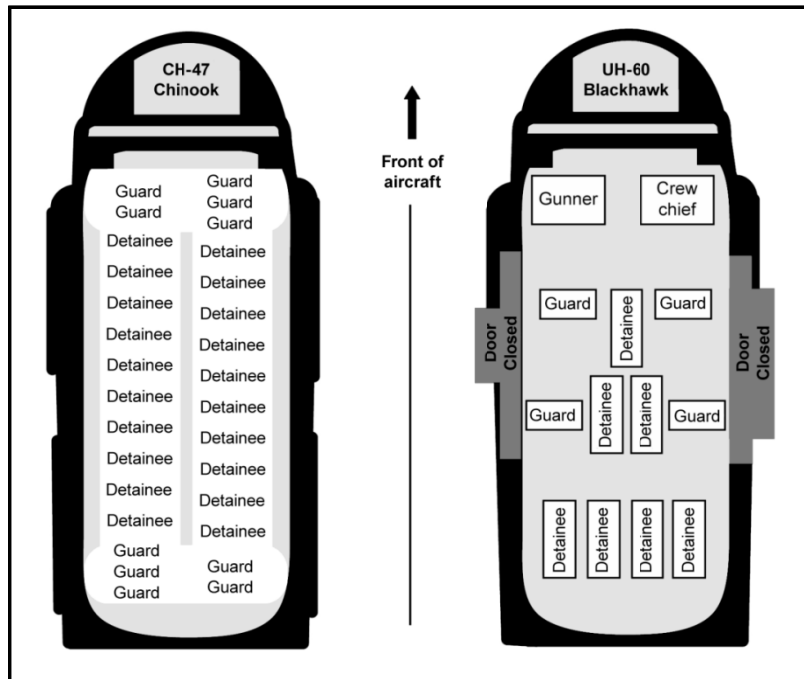

Figure 4-7. Movement by CH-47 and UH-60

AIRPLANE

4-61. Movement by airplane has similarities to movement by helicopter and other potential types of aircraft. An example of transport by C-130 is provided in figure 4-8. This example is but one of several variations based on the mission variables, but the basic relationships and positioning should be applicable in most situations. Variations that will affect the maximum number of detainees transported on an aircraft include, but are not limited to, elevation, fuel load, passenger collective weight, and other necessary considerations. The empty seats shown in this example may be further filled with additional detainees, Soldiers escorting detainees, and aircraft crew members. Once the aircraft is airborne, selected contact officers and members of the cockpit denial element leave their seats to conduct roving patrols of the detainees and ensure that they are better positioned to watch and respond to detainee actions.

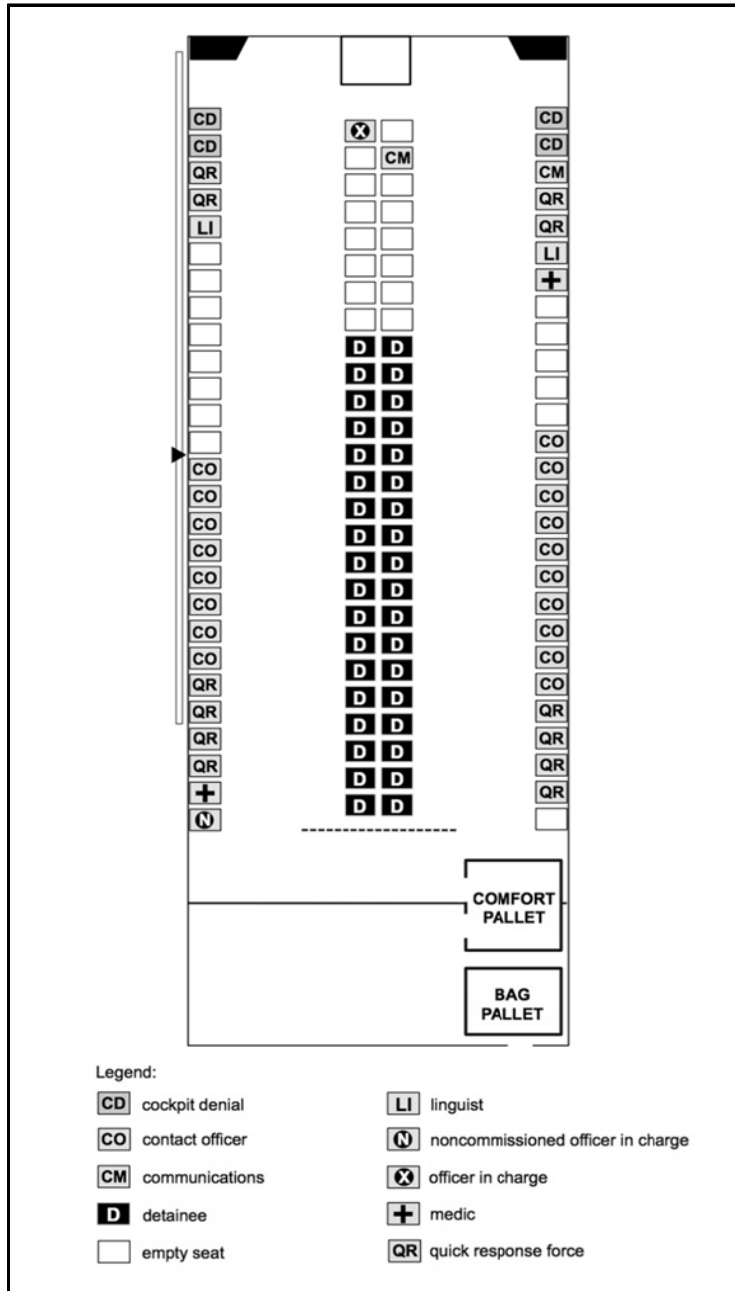

Figure 4-8. Movement by C-130 aircraft

DETAINEE RELEASE

4-62. Commanders responsible for detainee operations must understand the proper authority for the release of detainees at any echelon. (See chapter 9.) When a release is approved, the commander must—

- Ensure that detainees are segregated, outbriefed, and medically screened before release.
- Determine the receipt or transfer location.
- Determine the movement routes to the transfer location, and coordinate all routes through the appropriate combatant commanders.
- Make public notification of release and/or transfer only in consultation and coordination with the proper authority due to operations security concerns.
- Ensure that releasable confiscated personal property accompanies the detainees.
- Conduct an inventory of personal property and identify any discrepancies.
- Ensure that the detainees sign property receipts.
- Provide the detainees with appropriate and adequate food, clothing, and equipment for safe transition and movement.

This page intentionally left blank.

Chapter 5

Detainee Operations

Combat operations and stability operations in the war on terrorism continue to result in the detention of criminals, combatants, and civilians as military forces seek to support emerging democracies, mitigate the threat from terrorists, and quell insurgencies. A common lesson is the requirement to prepare for and conduct detainee operations as an integral part of full spectrum operations. Modern military actions, whether in a contiguous or noncontiguous environment characteristic of the war on terrorism, result in the capture of many and varied detainees. The war-on-terrorism detainee differs significantly from traditional EPWs of past conflicts and presents a potentially different and greater type of security threat during processing, escorting, and handling.

COMMAND AND CONTROL

5-1. The synchronization and clear understanding of C2 at all echelons is critical to the overall mission success. C2 clarifies key commander roles and responsibilities from POC to the Army service component command level. Although policy and joint doctrine updates are pending, this FM lays the groundwork for, and is nested with, current and emerging policy and joint doctrine regarding C2 during detainee operations.

RESPONSIBILITIES AT ECHELONS OF COMMAND

5-2. At each location and echelon of command conducting detainee operations, a commander must be responsible for those operations and exercise commensurate command authority to meet legal and operational requirements. Commanders at all units must ensure that detainees are accounted for and treated humanely. Elements not assigned to the commander executing detainee operations will be placed under tactical control or another appropriate command and support relationship to the internment commander for the humane treatment, evacuation, custody, and control (reception, processing, administration, internment, and safety) of detainees and the operation of the DCP, DHA, or internment facility. Tactical control provides authority for controlling and directing the application of force or capability for an assigned mission or task. It is intended for temporary situations and for specific tasks and missions that are normally explicitly stated. The MI commander is responsible for conducting interrogation operations (including prioritizing the effort) and controlling interrogation or other intelligence operations through technical channels.

5-3. At the theater Army level, the commander responsible for detainee operations is designated as the CDO. The senior military police commander normally serves as the CDO. The CDO does not normally serve as a detention facility commander. The CDO develops local policy and procedures for the commander's approval and dissemination and provides input to operation orders to ensure the uniform application of detainee operations policy and procedures at subordinate echelons. MI and medical units performing their assigned functions within a detainee facility establish and maintain a support chain through technical direction from their respective technical chain.

5-4. A military police commissioned officer should serve as the officer in charge of all U.S. DCPs unless no military police officer is available due to the operational situation. If a military police officer is not available to perform duties as the officer in charge of a DCP, the designated officer in charge must coordinate with the echelon PM for technical guidance regarding the treatment and processing of detainees to comply with Army regulations and U.S. and international laws. All DHAs and internment facilities will be commanded by a military police officer. However, this commissioned officer does not establish medical and interrogation priorities. The commander/officer in charge is responsible for the oversight of detainee

operations and must have unfettered access to all areas and operations. The commander/officer in charge provides technical direction to subordinate echelons.

5-5. The commander/officer in charge for detainee operations makes detainees available to authorized intelligence personnel for interrogation to the maximum extent possible, commensurate with requirements for humane treatment, custody, evacuation, protection, and administration. The commander/officer in charge is responsible for ensuring that policy and technical procedures for intelligence and medical operations are enforced through technical channels. The commander/officer in charge coordinates with the MI unit commander who is responsible for conducting interrogation operations. The intelligence staff maintains control through technical channels for interrogation operations to ensure adherence to applicable laws and policies and ensure the proper use of doctrinal approaches and techniques. Applicable laws and policies include U.S. laws, the law of war, relevant international laws, relevant directives (including DODD 2310.01E and DODD 3115.09), DODIs, operation orders, and FRAGOs. The officer in charge is also responsible for joint, interagency, and multinational personnel who are conducting detainee operations in U.S. facilities within an assigned AO.

Note. Non-DOD agencies must observe the same standards for the conduct of interrogation operations and the treatment of detainees as do Army personnel. The officer in charge of detainee operations possesses the authority over these personnel and is obligated to terminate or deny access to the facility and/or the detainees, as necessary, to stop or prevent inhumane treatment or a loss of custody and control. All personnel who observe or become aware of violations of Army interrogation operation standards will immediately report the infractions to the commander/officer in charge. For personnel who are not subject to the detainee operations chain of command and others who have been denied access to the facility or detainees, the officer in charge will report such access denial up the chain of command for resolution.

PLANNING CONSIDERATIONS

5-6. Detainee operations involve a wide array of operational and sustainment support to ensure compliance with U.S. and international laws. Proper planning before operations commence is vital and includes positioning military police, engineer, and other essential support element assets and construction materials early in the time-phased force deployment list. Commanders must also recognize that conditions for the successful execution of detainee operations are historically set in the planning phase of operations. To this end, commanders should establish planning mechanisms that ensure the effective consideration of potential detainee-related issues and the development of plans and procedures to respond to these issues as early in the planning process as feasible. In addition, training requirements, proper procedures, and an enhanced security plan all go into developing and maintaining a location where detainees are held and treated in a humane manner.

5-7. The planning should focus across the doctrine, organization, training, materiel, leadership and education, personnel, and facilities (DOTMLPF) domains to ensure that all requirements are met. Synchronization with adjacent staff elements and commands is another important element that must be considered.

5-8. Food sanitation, personal hygiene, and field sanitation standards must be met to prevent diseases and ensure the cleanliness of the facility. (See AR 190-8.) These standards are as follows:

- Provide adequate space within housing units to prevent overcrowding.
- Provide sufficient showers and latrines for detainees, and ensure that showers and latrines are cleaned and sanitized daily.
- Teach detainees working in the dining facility the rules of proper food sanitation, and ensure that they are observed and practiced.
- Dispose of human waste properly to protect the health of detainees and U.S. armed forces associated with the facility according to the guidelines established by preventive medicine.
- Provide sufficient potable drinking water and food service purposes. At a minimum, detainees should receive the same amount of water that is afforded U.S. military personnel.

- Provide sufficient water for bathing and laundry.
- Provide necessary materials for detainee personal hygiene.
- Train U.S. military personnel on the proper disposal of garbage (dining facility and personal) so as not to breed insects and rodents that can contribute to health hazards.
- Establish measures against standing water within the facility.
- Conduct pest control activities as required.
- Conduct medical, occupational, and environmental health surveillance.

5-9. Planning for detainees requires extensive and continuous coordination with supporting organizations. The construction of detainee holding facilities must meet health, well-being, and security requirements. Detainee operations may require support from all classes of supply, specifically—

- Class I items are required for detainees and military police personnel. Detainees are entitled to a sundry pack.
- Class II clothing is required for detainees, taking into consideration religious beliefs and accoutrements.
- Class III items may be focused on power production with some vehicular requirements.
- Class IV supplies are required and coordinated with engineer personnel to ensure that specific construction requirements are met.
- Nonlethal Class V supplies, such as small arms ammunition, are required for security personnel.
- Class VI items are required and supplied to detainees.
- Transportation is a critical requirement for detainee movement.

INTELLIGENCE AND INTERROGATION

5-10. Collecting intelligence from detainees will support intelligence operations and be valuable to operational success. It is critical to plan for adequate HUMINT collectors to interrogate detainees and meet intelligence and other information requirements. Interrogations may occur at all echelons (POC to the TIF/SIF). At the TIF/SIF, interrogations will normally occur at a colocated JIDC. Only qualified HUMINT personnel who have been trained and certified to perform interrogations will interrogate detainees.

5-11. HUMINT collectors screen all arriving ones to determine which detainees have information that may be of immediate tactical intelligence value to the maneuver commander. Military police facilitate control during screening.

5-12. To facilitate collecting enemy tactical information, MI personnel will collocate interrogation teams at the internment facility. This provides MI personnel with direct access to detainees and their equipment and documents. Military police and MI personnel coordinate to establish operating procedures that include the accountability of detainees.

5-13. An interrogation area is established away from the receiving and processing line so that MI personnel can interrogate detainees and examine their equipment and documents. If detainees or their equipment and/or documents are removed from the receiving and processing line, account for them on DD Form 2708 and DA Form 4137. Military police will escort detainees to and from the detainee building within the internment facility and will guard detainees during interrogations.

5-14. Interrogations of prisoners must be monitored, except as provided for under DODD 3115.09, even if questioning is being carried out by joint, interagency, or multinational personnel. If the monitored party does not adhere to DOD policies and procedures, the monitor will immediately terminate the interrogation. Additionally, the monitor will ensure that no recording which contains credible evidence of a suspected or alleged violation is destroyed.

5-15. The use of physical or mental torture or coercion of any kind is absolutely prohibited. Detainees are not threatened, insulted, or exposed to unpleasant or disparate treatment because of their refusal to answer questions. MWDs, contracted dogs, or any other dog in use by a government agency will not be used as part of an interrogation approach nor used to harass, intimidate, threaten, or coerce a detainee for

interrogation purposes. Failure to adhere to these outlined actions constitutes a serious violation of international laws and the UCMJ. All violations must be stopped by the monitor and reported immediately.

5-16. Intelligence representatives from the G-2X, J-2X, C-2X, and/or MI unit will provide interrogation expertise to the CDO staff. The HUMINT and counterintelligence representative will advise the CDO on all HUMINT and counterintelligence policy and operations.

5-17. Military police and MI personnel have associations with detainees, but each has different roles and responsibilities. According to U.S. policy, military police provide custodial care (to include subsistence, hygiene facilities, and accountability procedures), internment security, detainee escorts, and facility protection. MI personnel perform interrogation operations by using approved interrogation techniques. (See FM 2-22.3.) The execution of interrogation operations is coordinated with the detention facility commander to ensure visibility on detainee movement and accountability. Military police will not be directly or indirectly involved in interrogation operations or in setting conditions for interrogations beyond the responsibilities for monitors that are stated above. Military police may support MI personnel by providing detainee escorts and/or additional security (for example, for combative detainees) as requested. (See table 5-1.)

Table 5-1. Military police versus HUMINT responsibilities

	<i>Military Police</i>	<i>HUMINT</i>
Major Functions Performed from POC through Evacuation	<ul style="list-style-type: none"> • Process and restrain/control the detainee. • Conduct liaison with military and civilian agencies. • Transfer custody and maintain accountability of the detainee, evidence, and property. • Collect biometric information. • Move the detainee while he/she is restrained. • Report/investigate detainee abuse. 	<ul style="list-style-type: none"> • Screen and question detainees at traffic control points and checkpoints. • Question contacts, local civilians, and detainees. • Conduct liaison with military and civilian agencies. • Report information obtained. • Ensure that detainee abuse is reported. • Support document and media exploitation.
Internment Facility Tasks	<ul style="list-style-type: none"> • Detain and guard I/R populations. • Conduct reception and processing operations. • Coordinate for Class I, II, and VIII supplies. • Coordinate NGO, private organization, and interagency visits. • Ensure that detainee abuse is reported. • Transport detainees within the internment facility to the interrogation area. • Maintain security during interrogation operations. 	<ul style="list-style-type: none"> • Debrief guards. • Screen detainees for PIR and IR. • Provide linguist support when possible. • Observe detainees under military police control. • Ensure that detainee abuse is reported. • Conduct interrogations. • Report information obtained. • Cross-cue other intelligence disciplines as needed. • Support document exploitation.
Legend: HUMINT human intelligence IR information requirements NGO nongovernmental organization PIR priority information requirements POC point of capture		

5-18. Standard military police security, police intelligence operations, and I/R functions are the only involvement military police have in the interrogation process. Military police will—

- Exercise overall responsibility for the safety of detainees and HUMINT collectors, even in cases where detainees are in temporary custody of MI personnel or other agency personnel for interrogation.
- Never participate in the interrogation of detainees, set conditions for future interrogation operations, or provide or allow MWDs to be used to intimidate detainees in an effort to collect information.
- Maintain custody and control of the detainees.
- Provide observations of detainee actions and interactions to their chain of command and HUMINT personnel as appropriate.

5-19. MI personnel coordinate the implementation of the approved interrogation plan with the detention facility commander (or the security officer in charge at lower echelons) to synchronize interrogations. The detention facility commander/security officer in charge will also review interrogation plans with MI interrogators to develop or enhance appropriate safeguards and ensure humane treatment. Military police, guards, and/or security personnel are not responsible for reviewing, validating, or implementing interrogation plans. All military police noncommissioned officers (NCOs) and officers involved in detainee operations must be trained to understand interrogation policies, techniques, and legal limits to be capable monitors of interrogation activities and identify potential law and policy violations. Commanders must coordinate with MI and SJA to ensure that training includes the most current information and command guidance regarding approved interrogation activities. Military police also refer to FM 2-22.3 to identify general, approved interrogation techniques. The detention facility commander may coordinate with MI personnel to determine the best way for them to support interrogations without actually setting the conditions for interrogation activities.

5-20. Military police work closely with MI interrogation teams at the DCP to determine if detainees and their equipment and weapons are of intelligence value. This process is accelerated when HUMINT and counterintelligence collectors observe detainee arrival and in processing. If HUMINT collectors are language-qualified, they may be used as interpreters during this phase. Before detainees are interviewed by MI personnel, military police ensure that they have a DD Form 2745 attached to their clothing and are accounted for on DD Form 2708.

5-21. Military police follow strict guidelines concerning access to detainees, while ensuring that detainees are available for interrogation by approved HUMINT collectors. Accompanied and unaccompanied access to detainees must be coordinated and approved in advance by the military police commander (or the commander's designated representative) who is responsible for detainees. When a HUMINT collector coordinates detainee interrogations, military police escort detainees to the interrogation site and verify that the HUMINT collector has been given authorized access to the detainee. Depending on security concerns, the HUMINT collector may request that escorting military police remain at the interrogation site until (to ensure positive control or depart from) detainees are ready to be returned to their living areas. If escorting military police remain at the interrogation site, their functions are to maintain security, account for detainees, and maintain the safety of detainees and other personnel at the site. If positive control is not possible, detainees are signed over to the HUMINT collectors on DD Form 2708.

5-22. Commanders may consider implementing a standard practice in which detainees are medically screened before and after interrogations. This will ensure that a detainee's medical condition is always documented during all phases of internment.

5-23. Non-DOD personnel will coordinate with the military police and MI commander to sign for detainees that they want to question and will follow the same procedures established for DOD personnel. In all instances, non-DOD agencies are required to observe the same standards for the conduct of interrogation operations and treatment of detainees as do Army personnel.

5-24. HUMINT collectors will not turn over the detainee to anyone other than the escorting military police. Specifically, HUMINT collectors will not allow another government agency to assume custody directly from them. The HUMINT collector must return the detainee to the custody of the escorting military police,

and the agency seeking custody of the detainee will then be required to receive custody of the detainee from the escorting military police. Likewise, HUMINT collectors will not assume custody of a detainee directly from another government agency, but will direct that agency's personnel to return the detainee directly to the positive control of the escorting military police.

5-25. Military police may provide HUMINT collectors with information pertaining to the detainee's behavior and overall demeanor while in the TIF or SIF (such as a detainee's behavior during recreation and the type of people the detainee interacts with). Before turning the detainee over to a HUMINT collector for interrogation, the military police escort should inform the HUMINT collector of the detainee's behavior and demeanor during the detainee's movement to the interrogation site.

5-26. Military police keep records on detainees who appear to be leaders, create disturbances, and participate in hunger strikes. They observe patterns of behavior or communication within the detainee population that indicate unruly behavior. This type of information can be useful for HUMINT collectors during the interrogation process.

5-27. Any information provided to HUMINT collectors by military police should also be provided to the organic unit intelligence officer. Military police provide passive intelligence collection support through organic unit intelligence channels by reporting observations acquired in the course of their normal custodial and security duties.

5-28. Military police may provide incentives in support of interrogation operations if the incentives—

- Are requested by HUMINT personnel and have the MI commander's concurrence.
- Are coordinated with, and approved by, the detention facility commander.
- Do not violate standards of humane treatment.
- Do not violate detainee custody and control guidelines or facility security guidelines.

5-29. The commander may approve positive incentives at the local level. Any reduction in incentives or privileges must be approved by the first general officer in the detainee operations chain of command. The removal of incentives from detainees undergoing interrogation must be coordinated with the officer in charge of the interrogation element before removing the incentive.

Note. As long as incentives do not violate detainee custody or control or facility security, they may be used. For example, if MI personnel request that military police provide an incentive to the detainee (such as specialty food), but the detainee is acting inappropriately, that facility commander may deny the incentive. This response reduces the impact of reinforcing improper behavior. Additionally, denying a HUMINT personnel request for positive incentive will be coordinated with the MI commander and HUMINT personnel. Providing and withdrawing incentives does not affect the standards of humane treatment.

MEDICAL SUPPORT

5-30. Detainees will receive medical care that is consistent with the standard of medical care that applies for U.S. military personnel in the same geographic area. Medical personnel will provide detainees with the same care rendered to U.S. military personnel in the theater, which is generally a higher level of care than what is available locally. Medical support and the level of care available during detainee operations will vary based on the location of the facility, the situation, and the availability of qualified medical personnel and resources. The levels of care may be characterized as follows:

- Level I and II care includes—
 - Emergency and essential dental care.
 - Daily (sick call) routine care.
 - Monthly health assessments.
 - Simple laboratory work.
 - Optometry.
 - Portable radiology.

- Level III care normally includes (in addition to Level I care)—
 - An intensive care unit.
 - An operating room.
 - A radiology unit and a full lab.

5-31. Medical care at a DCP is provided according to necessity and is limited to emergency medical care only. DHA medical care is limited, but may include Levels I and II care. A TIF must provide at least Level II care and may be capable of Level III care. A hospital with the capabilities to support detainee operations is normally found at a SIF. (See appendix I for more information on medical support to detainee operations.)

5-32. Medical personnel are required to identify, treat, and document existing medical conditions and injuries of detainees. Distinguishing scars, marks, and tattoos will be documented by medical personnel and entered into the Detainee Reporting System by the facility Detainee Reporting System operator at theater level facilities for identification purposes. Medical personnel also prepare medical documentation, generate and control the disposition of medical records, and manage the release of medical information.

5-33. All medical screenings, examinations, and/or treatments conducted at prior locations, such as the DCP or DHA, will be available for review and inclusion in the detainee's medical record. All information that the Level I or Level II medical treatment facility documented on DD Form 1380 (*U.S. Field Medical Card*), Standard Form (SF) 558 (*Medical Record—Emergency Care and Treatment [Patient]*), and SF 600 (*Health Record—Chronological Record of Medical Care*), and/or other medical forms will accompany the detainee throughout the levels of medical care. Many times, these forms contain important information regarding the detainee's health status immediately after capture. Each entry helps provide a chronological picture of the detainee's medical condition during the time of the initial detention. In addition, the medical treatment facility may have taken useful photographs of injuries that were healing or were already healed by the time the detainee arrived at the TIF.

5-34. Commanders must consider the following when establishing medical care at the internment facility:

- A credentialed health care provider examines detainees monthly and records their weight on DA Form 2664-R (*Weight Register [Prisoner of War]*). The Detainee Reporting System requires weight data from the medical community.
- The general health of detainees, their nutrition, and their cleanliness are monitored during inspections.
- The detainees are examined for contagious diseases (especially tuberculosis), lice, louse-borne diseases, human immunodeficiency virus (HIV), and sexually transmitted diseases.
- All medical treatment facilities must provide immunizations for, and isolation of, detainees with communicable diseases.
- Retained medical personnel and detainees with medical training are used to the fullest extent possible in caring for sick and wounded detainees.
- Detainees who require a high level of care are transferred to military or civilian medical installations where the required treatment is available.
- Military police escort detainees to medical treatment facilities and remain with them until medical examinations are complete.
- Detainees interned at the TIF receive Level II or higher medical care as required (including dental and optometric care).

Note. Details of medical operations specific to the DCP, DHA, TIF, and SIF are provided in each location discussion. (See appendix H and AR 190-8.)

5-35. All Behavioral Science Consultation Team members are authorized to make psychological assessments of the character, personality, social interactions, and other behavioral characteristics of interrogation subjects and to advise authorized personnel performing lawful interrogations regarding such assessments. Those who provide such advice may not provide medical care for detainees, except in an emergency when another health care provider cannot respond adequately. All behavioral science

consultation team members serving in behavioral science consultant positions should receive structured training on their roles and responsibilities while functioning in this capacity. In addition, MI personnel should clearly understand the defined roles, responsibilities, and limitations of behavioral science consultants.

5-36. Military police will provide security, retain custody, and maintain control of detainees during all medical interactions, to include simple examinations. Detainee health care personnel will not provide detainee security, custody, or control for even brief instances, nor will there ever be the perception that health care personnel provide such functions (for example, they will not carry handcuffs or disposable restraints). Detainees are entitled to receive, and medical personnel will try to allow, some level of privacy consistent with security requirements. The medical staff finds contraband on a detainee during the course of a medical examination, they will give it to appropriate security personnel.

5-37. Military police also provide behavioral control. Any detainee who fails to follow orders or rules can be disciplined appropriately by military police. Medical personnel should not discipline or participate in the discipline of detainees. They will immediately report any problems to the onsite military police authority.

5-38. Medical interactions must always involve military police overwatch, whether inside or outside the compound. As a rule, medical personnel will not carry weapons within the detention compound. (This is for their safety and is generally dictated by the MPC.) Since most outpatient care occurs inside the detention compound, military police must be vigilant in protecting the safety of medical personnel. Even the most friendly or helpful detainee may be harboring the desire to harm a Soldier, even if that Soldier is a medical provider.

5-39. Military police or other internment facility personnel will never have routine access to open medical records, and a detainee's medical information will never be used during interrogation. Medical personnel will provide military police medical information required in the Detainee Reporting System. Further, medical personnel must keep military police and MI personnel apprised of any medical conditions that detainees have when could affect the conduct of detainee interrogation operations. For example, military police and MI personnel should know that a detainee is diabetic to prevent harm that might result from changes in the detainee's diet. Because the internment facility military police chain of command is ultimately responsible for detainee care and treatment and the welfare of assigned personnel, they require and should receive adequate and appropriate medical information to keep apprised of detainee medical conditions. (See appendix H.) For example, detainees who are suspected of having infectious diseases should be separated from other detainees. Guards and other personnel who come into contact with such detainees should be informed about their health risks and apprised on how to mitigate those risks. When transferring detainees from one facility to another, sealed medical records may be transported by military police who are escorting them.

5-40. Any detainee refusing food for 72 hours is considered to be on a hunger strike. Military police will refer detainees who are refusing food to medical personnel for evaluation and possible treatment.

5-41. Medical personnel will immediately report allegations or suspicions of abuse to military police or CID personnel, but will not conduct investigations. When physical, sexual, or emotional abuse is alleged or suspected, medical personnel will immediately report the situation to the military police and the supporting CID unit. It is the role of CID personnel and/or the military police are responsible for investigating allegations, collecting evidence (such as photographs), and identifying perpetrators.

DENTAL SUPPORT

5-42. The scope of dental services available to detainees is determined by the detainee operations medical director according to established theater policy. Operational dental support (emergency and essential) is normally available within a joint operations area. Comprehensive dental care is normally provided in a support base, but not in a deployed setting. Internment facilities do not have organic dental personnel or equipment. Depending upon the anticipated dental workload, dental assets may be colocated with the internment facility. If dental assets are not colocated with the internment facility, coordination with the supporting dental facility is required. The internment facility must provide the required guard support for detainees who are being transported to the supporting dental facility.

SPECIFIC DETAINEE SUPPORT REQUIREMENTS

5-43. There are numerous requirements for support and care of detainees within U.S. military control. The following paragraphs provide details regarding selected detainee support requirements. These requirements and their implementation should be addressed within unit SOPs. (See paragraph 5-103.)

MAIL AND CORRESPONDENCE

5-44. Detainees may be permitted to send and receive correspondence. They may also address complaints (in writing) to U.S. military authorities and the protecting power. CIs may be denied communication rights in cases where absolute military security requires. Commanders should consult with their supporting SJA on a case-by-case basis to determine privileges afforded to detainees.

5-45. There are no restrictions on the number of letters, cards, or parcels detainees may receive. Detainees will be permitted to send no more than two letters and four cards monthly, in addition to the capture cards provided for in Article 70, GPW. Letters and cards from detainees sent by ordinary mail are postage free.

5-46. Detainees will not send maps, sketches, or drawings in outgoing correspondence. They will not be permitted to mail or receive registered, certified, insured, or cash-on-delivery mail. Detainees may not write letters for others who are able to write. If a detainee is unable to write, the detention facility commander may permit another person to write a message for him/her. The person writing the message will countersign.

5-47. Detainees may be authorized to receive individual parcels and collective shipments containing the following items if they do not impede security procedures within the facility:

- Foodstuffs.
- Medical supplies.
- Articles of a religious, educational, or recreational nature.

5-48. Detainees will not be permitted to mail parcels. Any parcels received for transferred persons will be forwarded immediately.

5-49. Correspondence procedures are as follows:

- Outgoing letters and cards will be secured by using locked boxes or similar means.
- Only authorized U.S. military personnel will handle mail. Detention facility commanders will designate a U.S. Soldier to supervise the opening of all mail pouches containing incoming letters and cards for detainees. These items will be carefully examined by the U.S. Soldier before delivery to detainees. The contents of all incoming parcels will be examined at the facility by a U.S. officer in the presence of the addressee or the named representative.
- The detention facility commander may request that parcels be examined by a censorship element when considered necessary. The articles in each parcel will be removed. The wrappings, the outer container, and any extraneous items found in the parcel will not be given to the detainee. Examination will be close enough to reveal concealed articles and messages; however, will avoid undue destruction of parcel contents.

5-50. A censorship policy of detainee mail may be instituted by the theater commander as follows:

- Outgoing letters and cards may be examined and read by the detention facility commander or a designated representative.
- Mail will be returned to the sender to rewrite portions that contain obvious deviations from regulations, and a copy will be provided to the supporting counterintelligence element.
- Outgoing letters and cards will be sent, unsealed, directly from the facility to the theater commander's designated censorship element. All incoming letters and cards that arrive at a facility without having been censored will be sent to the designated censorship element before delivery to detainees.

5-51. Letters and cards addressed to persons other than representatives of a protecting power or to U.S. military authorities will not—

- Contain complaints or criticism of any governmental agency or official.
- Refer to events of capture.
- Compare camps.
- Contain quotations from books or other writings.
- Contain numbers, ciphers, codes, music symbols, shorthand, marks, or signs other than those used for normal punctuation.
- Contain military information on the number of detainees.

5-52. Should any such correspondence be discovered, it will be turned over to the supporting counterintelligence element.

TELEGRAMS AND TELEPHONE CALLS

5-53. Detainees may send and receive telegrams as determined by the detention facility commander. The cost of sending the telegram is deducted from the detainee's account. Detainees are prohibited from making or receiving telephone calls. (See AR 190-8 for more information on sending and receiving telegrams and telephone communications.)

DETAINEE REPRESENTATION

5-54. A limited system of representation will improve communications between U.S. armed forces and the detainees, thus improving control. According to AR 190-8 and the Geneva Conventions, the senior detainee officer assigned to each facility is recognized as the senior detainee representative, unless the senior detainee representative is declared incompetent or incapacitated by U.S. authorities. Enlisted detainees may elect an enlisted representative if there is no officer representation at the facility. In officer detainee compounds within internment facilities, one or more advisors are chosen by the interned officers to assist the senior representative. An internment facility of a mixed population of officers and enlisted Soldiers will have one or more enlisted advisors elected to assist the detainee officer representative.

5-55. Within current and future OEs, it is highly likely that large numbers of civilian detainees and members of armed groups with no recognized grade structure will be detained. At a minimum, CIs and detainees with no formal leadership will be authorized to elect a committee of representatives every 6 months or upon the vacancy of a representative position.

5-56. Elected and appointed representatives must have the same nationality, customs, and language as those they represent. Each group of detainees interned in separate internment compounds (because of language, customs, or ideology) may have an elected representative.

5-57. The primary duties of elected detainee representatives are to promote the spiritual, physical, and intellectual well-being of the detainees they represent. Representatives may be given the freedom of movement within security requirements. They do not have the authority to discipline prisoners, but may be allowed to—

- Inspect work details.
- Receive supplies.
- Communicate with—
 - U.S. armed forces authorities.
 - Protecting powers. (Protecting powers will periodically inspect the internment facility and interview the detainees regarding the conditions of their internment and welfare and the protection of their rights under international laws.)
 - The ICRC and its delegates.
 - Medical commissions.
 - Other organizations authorized to assist detainees.
- Use postal and other appropriate facilities (within constraints previously described).

5-58. Representatives should not perform any other work that interferes with their duties as representatives. Each representative is elected by secret ballot and serves a term of up to 6 months.

5-59. Detainees are permitted to consult freely with their representative and, in turn, the representative is allowed to represent them before—

- The ICRC.
- Protecting powers.
- U.S. armed forces authorities.
- Other relief or aid organizations (NGOs and IOs) authorized to represent detainees.

5-60. The detention facility commander is designated as the final approval authority for each elected detainee representative. If the detention facility commander disapproves of an elected member, the reasons are stated in writing and forwarded through channels to the TDRC, NDRC, and protecting powers. If the commander dismisses a representative, the detainees are permitted to elect another representative. After the approval process is complete, the representatives may assume their duties. Each elected representative may appoint assistants. The assistants are also subject to the approval of the detention facility commander.

5-61. Medical and chaplain personnel are classified as RP and will receive, at a minimum, the benefits and protection afforded EPWs by the GPW. (See chapter 1.) The detainee operations medical director and (or designated representative) or the foreign national medical officer at each internment facility is responsible for the activities of retained medical personnel. Senior retained medical officers and chaplains have the right to correspond and consult with the detention facility commander on all questions concerning their duties.

EMPLOYMENT AND COMPENSATION

5-62. Basic policies and procedures for the administration, employment, and compensation of detainees in the custody of the U.S. armed forces are discussed in AR 190-8. This regulation also implements the provisions of the Geneva Conventions that relate to the treatment of CIs who are interned by the U.S. in the occupied territory of their country.

VISITATION

5-63. Detainee visitations are a deliberate operation, resource-intensive, and a significant IO builder. The detention facility commander may grant visitation privileges depending upon the detainee's conduct and disposition while in detention. Visitation must be formally requested and scheduled with the fixed facility detainee visitation office by the person(s) wishing to visit with a detainee. Scheduled visitation is based on the number of visitations that may be accommodated for a specific visitation day. Visitors requesting to visit with a detainee must provide or obtain their own transportation to the fixed facility on the specific day that a visitation is scheduled. Visitation staff and guard forces must know in advance who was scheduled for visitation, and security measures must be put in place. Visitations take place within the site and require the following security measures before visitors can be granted access:

- Visitors are only allowed to arrive and request permission to enter through a specific gate. They must check in with the U.S. guards manning the visitation security gate access point.
- Guard forces must verify that personnel requesting visitation are scheduled and that they provide a legitimate form of identification before access is granted. Upon verification of identity and scheduled visitation for that particular day, visitors move to the visitor holding area that immediately follows the visitor access point.
- Once inside the facility, the visitor's identification is checked a second time by the visitation staff. Visitation staff members used interpreters to explain visitation procedures to visitors. Visitors are required to submit to physical searches and biometrics enrollment using the Biometrics Automated Toolset before they are allowed to move to the next phase of visitation processing. If a visitor refuses to be searched or fails biometrics enrollment/verification, the visitor should not be authorized to visit the detainee and should be escorted off the compound by security personnel. Additionally, if a visitor refuses to complete inprocessing requirements, the visitation staff records it.

- Once biometrics enrollment and verification is complete, visitors, are seated in a lobby and provided a visitor orientation.
- When detainees are removed from fixed facility compounds, detainee ISNs are verified by the compound guard commander, and the detainee's ISN is entered into the Detainee Management System. As detainees are removed from compounds, they are secured and then escorted to the bus that transports them to the visitation area.
- Separate bus or truck guards are used to control the detainees after they are placed on vehicles. When all detainees are on buses or trucks, they are transported to the visitation area under escort. Escorts are used to prevent detainees from talking to or intimidating each other, coordinating, or planning any subversive action against guard forces.
- At the visitation area, guards remove detainees from buses and escort them to a secure holding area out of sight of visitors. When all detainees are in the secure compound and an accurate headcount of detainees is complete, they are searched a second time by guard forces who are conducting the escort. Detainees are left in the secure holding area, under guard, until removed and escorted to the building where the visitation takes place. Guards escort all detainees receiving visitations in the same building at the same time.
- Generally, only eight to ten detainees are allowed to conduct visitations in the same building at a time. Three visitation buildings are used at a time for visitations. The guard-to-detainee coverage is mission variable-dependent but averages one guard to every six detainees. HN corrections officers assist in guarding and observing visitations in each individual visitation building. Detainees are escorted into the visitation building and seated by position on the visitation roster. Once seated and briefed on visitation rules, guards escort the visitors and position them across from the visited detainee. The visitation building is split down the middle by a wall with open window cutouts to allow visitors and detainees to sit across from, and maintain view of, one another.
- During the visitation session, visitors are not allowed to have any physical contact with the detainee or pass anything through the opening without the expressed consent of the guards. Any detainee caught attempting to have physical contact or take something from a visitor without proper consent is immediately removed from the visitation site, searched, and escorted back to the holding area.

Note. Detainee visitors are not be allowed to interact with, view, or overhear conversations of MI personnel (and their associated colleagues) or any other U.S. or multinational person who is waiting to interact with, or detainees. When planning the layout of interrogation rooms (visiting booths and areas in the immediate vicinity of corridors leading to and from these areas) commanders and staffs must keep detainee visitors isolated from other individuals who are working in the I/R facility, specifically MI personnel and their associated colleagues. Finally, when establishing an SOP for interrogations and detainee visits, consideration for precluding the interaction of detainee visitors and MI personnel and their associated colleagues are carefully addressed.

5-64. Visitations normally last between 1 and 2 hours, depending on the number of visitations scheduled. While detainees are conducting visitations, guard forces strictly monitor visitation events and conversations. Guards and interpreters should observe detainee or visitor verbal and nonverbal actions. Additionally, guards should look for gestures that may be used as codes or actions that may be symbolic of some sort of clandestine communications method.

Note. Guard forces and fixed-facility staff reserve the right to end visitation sessions any time the threat environment within the fixed facility increases for any reason. In the event this occurs, detainees are to be placed back into the holding area and visitors are escorted back to the visitation processing center and then offsite through the visitation gate.

5-65. Following visitation, detainees are placed back in a holding area and searched. At the same time, visitors are returned to the visitation reception area, searched, and escorted to the gate for release from the

compound. Throughout the entire visitation process, detainees and visitors must be treated with precise respect and courtesy. Local customs are upheld as much as possible, unless they become an issue with security requirements set forth by the detainee visitation policy.

DETAINEE DEATHS

5-66. In the event of a detainee's death, the commander of the internment facility or hospital (if the death did not occur in a facility, the commander of the unit that exercised custody over the detainee) will immediately report the death to the U.S. Army Criminal Investigation Command or another appropriate military criminal investigative organization. Upon the initial determination of death, the location will be protected as a crime scene until released by the U.S. Army Criminal Investigation Command. If the U.S. Army Criminal Investigation Command cannot immediately respond to the location of the death, photographs will be taken of the body and the scene before moving and/or transporting the body. These photographs will be provided to the U.S. Army Criminal Investigation Command or another appropriate military criminal investigative organization. The remains will be secured and unaltered pending instructions from the U.S. Army Criminal Investigation Command or another appropriate military criminal investigative organization. The remains will not be washed, and all items on or in the body will be left undisturbed, except for weapons, ammunition, and other items that pose an imminent threat to the living. These items will be secured, if necessary, for personal safety reasons by an appropriate authority and preserved for assessment by the U.S. Army Criminal Investigation Command or another appropriate military criminal investigative organization. The body will not be released from U.S. custody without written authorization from the U.S. Army Criminal Investigation Command or another appropriate military criminal investigative organization. The investigating military criminal investigative organization will contact the Office of the Armed Forces Medical Examiner, which will determine whether an autopsy will be performed. In the case of detainee's death, it is presumed that an autopsy will be performed, unless an alternative determination is made by the Office of the Armed Forces Medical Examiner. Medical determination of the cause and manner of a detainee's death is the sole responsibility of the Office of the Armed Forces Medical Examiner or another physician designated by the Office of the Armed Forces Medical Examiner.

5-67. If a detainee dies at the POC, U.S. armed forces are still obligated to process the detainee through medical channels and processes. This obligation is based on the detainee actually being in the custody of U.S. armed forces. Detainees who die before processing into a TIF will not be assigned an ISN.

5-68. In the event of a detainee's death, obtain a DD Form 2064 (*Certificate of Death [Overseas]*) or an authenticated roster of the dead and the exact location (grid coordinates) of the grave. Commanders and Soldiers must take into account the local customs regarding death and burial. In some cases, a detainee who dies while in U.S. custody must be buried within a specific timeline according to the customs of that detainee. Failure to take this into account may disrupt any positive relations established by U.S. armed forces and the local population. Such an accounting does not supersede the commander's responsibility to ensure that the remains are available for the required autopsy and death investigation.

5-69. When a detainee in U.S. custody dies, the attending medical officer will immediately furnish the detention facility commander or hospital commander (or the commander of the unit that exercised custody over the detainee if the death did not occur in a facility) with the—

- Detainee's full name.
- Detainee's ISN/capture tag (mandatory).
- Date, place, and circumstances of the detainee's death.
- Initial assessment as to whether the detainee's death was, or was not, the result of the deceased's own misconduct.
- The initial assessment as to the cause of death.

5-70. Notifications of all detainee deaths will immediately be reported from the detention facility commander to the CDO. The CDO will notify the regional combatant commander, who will notify the Secretary of Defense through the CJCS. Parallel notification through normal chains of command and technical channels will also be performed. The TDRC will be notified and will report the death to

Headquarters, DA, as a serious incident report per AR 190-45. The data listed in paragraph 5-47 will be included in the serious incident report. All supplemental reports will clearly reference the original message with the original date-time group.

5-71. The attending medical officer, together with the appropriate detention facility commander or hospital commander, will complete DD Form 2064 (*Certificate of Death Overseas*) and SF 600. These forms are used for all detainees who die while in U.S. custody or control and are the only authorized forms. The deceased's full 13-digit ISN will be included in the block labeled "Name of Deceased." All relevant information known at the time will be included on the DD Form 2064. The medical officer and the commander will sign the completed DD Form 2064 and SF 600. The DD Form 2064 and SF 600 will be annotated to reflect that the final medical determination of the cause and manner of death is solely the responsibility of the Office of the Armed Forces Medical Examiner, except in circumstances when an autopsy is not conducted (that is, a request is made for no autopsy by family members), and that when the Office of the Armed Forces Medical Examiner determines the cause of death, a supplemental report will be made as soon as possible. The required distribution of a completed SF 600 is as follows:

- Give the original to the NDRC within 72 hours of signature.
- Give one copy to the surgeon general within 72 hours of signature.
- Give one copy to the TDRC within 48 hours of signature.
- Place one copy in the detainee's personnel file.
- Give one copy to the civil authorities responsible for recording deaths in that particular state within 72 hours of signature if a detainee dies in the United States.

5-72. The U.S. Army Criminal Investigation Command or another appropriate military criminal investigative organization is solely responsible for investigating all cases of death or serious injury caused or suspected to have been caused by guards, sentries, other detainees, or any other person. Once the U.S. Army Criminal Investigation Command or another appropriate military criminal investigative organization has completed the official investigation, the Office of the Armed Forces Medical Examiner is responsible for completing a final DD Form 2064 that will include a statement that "death was (or was not) the result of the deceased's own misconduct" in the block labeled "Circumstances Surrounding Death Due to External Causes."

5-73. The NDRC will notify the ICRC of all detainee deaths. The NDRC will maintain detainee DD Forms 2064 for the period of hostilities or occupation, for the duration of any other military operation, or as otherwise directed. When authorized, the NDRC will archive detainee DD Forms 2064.

LEGAL CONSIDERATIONS

5-74. During the conduct of hostilities, the U.S. and its citizens (to include U.S. armed forces) operating in support of those operations are bound by the law of war, which encompasses all international laws and applicable customary international laws and treaties and international agreements to which the U.S. is a party. (See DODD 2311.01E and Chairman of the Joint Chiefs of Staff Instruction [CJCSI] 5810.01C.)

5-75. Multiservice directives such as AR 190-8, Chief of Naval Operations Instruction 3461.6, Air Force Instruction (AFI) 31-304, and Marine Corps Order 3461.1 address legal considerations when conducting detainee operations. In addition, DODD 2310.01E outlines legal issues regarding the reception, treatment, processing, and release of detainees. The Geneva Conventions are the primary references for conducting detainee operations.

PUBLIC AFFAIRS

5-76. Public affairs planning requires an understanding of the information needs of Soldiers, the Army community, and the public in matters related to detainees and the facility. The public affairs officer also facilitates media efforts to cover operations by expediting the flow of complete, accurate, and timely information. In the interest of national security and the protection of detainees from public curiosity, detainees will not be photographed or interviewed by the news media.

5-77. When conducting civil-military operations, U.S. armed forces must—

- Provide technical advice and assistance in the areas of continuous community relations and information strategies.
- Plan positive and continuous community relations programs to gain and maintain public understanding, goodwill, and support for military operations.
- Provide liaison and coordinate with other U.S. government agencies; HN civil and military authorities concerned with I/R operations; and NGOs, IOs, and international humanitarian organizations in the operational area.
- Coordinate with the SJA concerning advice given to commanders about ROE for dealing with detainees.
- Providing technical advice and assistance in the reorientation of detainees.

5-78. The following general principles are applicable to the administration of internment facilities and may be applicable to all types of detainees:

- Use detainees for the internal maintenance and operation of the internment facility as much as possible.
- Use properly captured or seized (pursuant to the law of war) enemy supplies and equipment (excluding weapons and ammunition) to the maximum extent possible. Additional items may include computers, cell phones, personal digital assistants, and pagers. Supplies and equipment have changed from a strictly military nature to include the type of items normally found at a civilian market. Consultation with the DOD Office of the General Counsel is recommended for further clarification.

STRATEGIC REPORTING

5-79. Commanders must be aware of detainee reporting requirements and must plan accordingly. The timely and accurate reporting of data through the Detainee Reporting System is critical to ensuring detainee accountability and compliance with U.S. and international laws. The NDRC is the executive agent and archive for all detainee information, while the TDRC functions as the field operations agency and data collection point for the NDRC. The TDRC reports all detainee data directly to the NDRC. Internment facility commanders are responsible for the initial entry and maintenance of detainee personnel records in the Detainee Reporting System.

5-80. Once an ISN is assigned, further documentation and reporting will use only the ISN number (no other numbering system will be used). Before issuing an ISN, only the DD Form 2745 number will be used to identify the detainee. Blocks of ISNs are issued to the TDRC. ISNs are used to link detainees with biometric data (for example, DNA data, personal property, medical information, and issued equipment).

5-81. Planning consideration must also be given to detainee identification bands. These color-coded bands, issued to each detainee based on grade or detainee status, permit the rapid and reliable identification of each detainee.

5-82. Expect detainees to exchange or tamper with the bands to confuse accountability efforts. Periodic routine inspections of randomly selected identification bands should take place in the mess line, during compound inspections, or at any other opportune time. A 100 percent check of identification bands during daily head counts will aid in finding identification band discrepancies and correcting potential accountability problems early.

TRANSFER AND TRANSITION

5-83. The detention facility commander, according to applicable procedures, will oversee the transfer or release of a detainee from a DCP or a DHA. All proposed transfers or releases are reviewed by the legal advisor to ensure compliance with applicable laws and policies and are approved by the appropriate authority. Unless prohibited by command policies, immediate release of detainees may be made at the POC based on the decision of the appropriate authority on the ground. The decision is based on criteria established by higher headquarters.

5-84. The permanent transfer or release of detainees from the custody of U.S. armed forces to the HN, other multinational forces, or any non-DOD U.S. government entity requires the approval of the Secretary of Defense or a designee. The permanent transfer of a detainee to a foreign nation may be governed by bilateral agreements or may be based on ad hoc arrangements. Detainees may only be transferred according to the requirements of applicable international laws and policies.

5-85. U.S. armed forces must be trained and logistically supported to conduct transfer and release operations. The joint force commander—

- Ensure that all transfer and/or release operations are conducted according to applicable laws and policies.
- Determines air, land, or sea transportation requirements for transfer and release operations from the POC through the unit responsible for that joint operations area.
- Establishes the C2 relationship between all elements involved in transfers and/or release operations.
- Ensures that notification is made of the transfer and release of a detainee to the NDRC.
- Develops detainee policies regarding transfer and release operations according to applicable laws and policies.
- Coordinates with appropriate commanders and staffs to ensure that transfer and release operations are disseminated throughout the joint operations area.

5-86. Senior military police leaders must plan detainee operations and continually ensure that are conducted in a manner which enables the conditions for the later transition of detainees to indigenous justice and penal systems. As the transition from combat to stability operations occurs, military police I/R personnel will most likely shift their focus to more complex/unique I/R skills that are required to support strategic penal system development. I/R trained Soldiers must anticipate conducting operations and training with indigenous forces to increase their capability and to achieve long-term strategic objectives. Commanders plan for the movement of detainees and their property throughout the operational area and maintain strict accountability of both throughout all movements.

LIAISON WITH EXTERNAL AGENCIES

5-87. These interests and support activities of these agencies include ensuring that proper and humane treatment is given, protecting the rights of others, and ensuring that provisions for subsistence are present for persons affected by I/R operations.

5-88. During the course of detention operations, U.S. commanders will encounter representatives from these agencies attempting to assert a role in protecting the interests of detainees. Upon initiation of detention operations, commanders must anticipate that these organizations will request access to and/or information about detainees and will continue to do so throughout the operation. Commanders should seek guidance through operational command channels before responding to such requests, before initiating detention operations, or as soon thereafter as possible. In the absence of mission-specific guidance, all such requests for access or information should flow via the established chain of command to the Office of the Secretary of Defense. Commanders must also be cognizant of the special status of the ICRC and facilitate ICRC access to detainees for interviews, assistance, and reporting.

Note. Appendix D addresses background information about various types of government agencies, IOs, NGOs, and international humanitarian organizations who have an interest in I/R operations.

SECURITY REQUIREMENTS

5-89. Security planning must be continuous and complete to reflect current intelligence relating to the nature and characteristics of the individuals under custody and control. Specific planning must be completed to ensure that capabilities are available to prevent and thwart group disobedience, uprisings, outbreaks, and escapes. Planners must provide for an immediate response that is capable of meeting any

internal or external threat to the security of the specific facility. Military police should never forfeit their ability to maintain positive control.

5-90. The physical construction of the DCP, DHA, or TIF and the presence of guard personnel create the most obvious means of providing security, internally and externally. The use of existing structures is ideal for conducting detainee operations. The facility commander plans for and executes effective perimeter security operations for the internment facility. Planners should enforce a double-barrier system along external perimeters (sally ports, access control points). At a sally port, where there are two means of entry, both entry points should never be open at the same time. Security forces should implement random security and search measures inside cells and in other areas where detainees congregate. Military police should strictly enforce weapons discipline by adhering to weapons clearing and turn-in procedures.

5-91. Military police leaders will regularly rehearse contingency response plans and appropriate ROE and RUF. Military police will always maintain positive control of the detainee during internal escorts. During minor medical situations, guards will not normally transfer positive control of the detainee over to medical personnel. Detainees will remain restrained, as appropriate, during medical evaluations.

5-92. To the maximum extent possible, places of detention will be protected from the hazards of the battlefield. To protect detainees, commanders must manage the control of captured protective equipment that could be used to meet detainees requirements. The commander also ensures that detainees derive the same benefit from protection measures as do members of the detaining force when planning protection measures.

5-93. The adherence to the RUF is a necessary element in maintaining order. Personnel assigned the mission of providing control of detainees and security of the internment facility should be issued and trained on the RUF specific to that mission. Theater ROE will remain in effect for defending the internment facility from an external threat.

Note. Personnel will not carry weapons inside designated areas such as compounds, confined spaces, or cells. At the commander's direction, NLWs may be carried within compounds.

5-94. A weighted effort must be considered when computing the guard-to-detainee ratio and leader requirements. Most escape attempts, discipline problems, and similar issues occur at night, or during the hours of darkness. Senior NCOs and officers will maintain a noticeable and continuous presence during night operations. The computation for guard-to-detainee ratio is not a fully defined or established number. There are many indicators or factors that must be applied when determining such a ratio at any echelon where detainee operations may occur. These factors include, but are not limited to—

- The operational variables.
- The number of detainees at the location.
- The type of detainees at the location (violent, compliant).
- The number of trained guard force personnel.
- Additional competing mission priorities.
- The number of supporting personnel required to maintain and sustain the level of security needed, including reaction force personnel, basic subsistence personnel (food and supply), and other augmentation as needed.
- Infrastructure configurations that may lead to adding or deleting guard personnel, may include the type and amount of lighting available, the type of cells or compounds, the physical security aspects of the facility (concertina wire, razor wire), and the C2 structures.
- Any intrusion type technologies, adopted and implemented, that may lead to adding or deleting guard personnel.
- Supporting materials (loud speakers, radios) that would assist in maintaining security at a location.

NOTICE OF PROTECTION

5-95. A copy of a notice of protection in the detainees' language is posted in every compound to protect persons from acts of violence, bodily injury, and threats of reprisals at the hands of fellow detainees. The notice will read as follows: "Detainees who fear that their lives are in danger or that they will suffer physical injury at the hands of other detainees will immediately report the fact personally to any U.S. military personnel of this internment facility without consulting the detainee representative." From that time on, the facility commander ensures adequate protection by segregation, transfer, or other means. The notice will also state the following: "Detainees who mistreat fellow detainees will be punished," (this is signed by the commanding officer). If some detainees are unable to read, this notice should be read to them to ensure that they understand their protective rights.

USE OF RESTRAINTS

5-96. Restraints include a broad spectrum of approved devices that are used to control, secure, restrict, or immobilize a detainee's movement. Always apply the minimum level of restraint necessary to control the detainee. Restraints will only be applied to mitigate the risks associated with controlling the detainee while processing, escorting, or transporting or to prevent the detainee from self-harm.

5-97. Restraint measures will only be used to control a detainee's movement or to prevent self-destructive or threatening behavior. When necessary, restraints are used on detainees for medical or psychiatric purposes.

5-98. The special restraint (for example, restraint chairs)of detainees requires the TIF commander's prior approval under nonemergency situations. For emergency situations, the guard commander or sergeant of the guard has the authority to authorize the use of restraint chairs; however, the facility commander must be notified immediately. A maximum of 2 hours in a restraint chair may be authorized by the sergeant of the guard or guard commander. The facility commander can authorize an additional hour for a total of 3 hours prior to returning the detainee to his cell. Apply the following guidelines when using restraints:

- Use restraints at all times when in contact with or when handling, escorting, or transporting detainees.
- Inspect restraints on a routine basis to ensure that they are secure without restricting circulation.
- Remove restraints when detainees are placed in a detention cell or another adequate space.
- Use restraints within a detention cell only at the direction of the commander to protect detainees from self-harm. If restrained in a cell, detainees must—
 - Be constantly monitored to mitigate a potential risk self-harm.
 - Be segregated in an appropriate environment.
- Do not routinely restrain detainees to fixed structures or fixed objects.

Note. Securing leg irons to the floor to limit movement during interviews/interrogations may be authorized by the first general or flag officer in the chain of command. When transporting, an approved vehicle safety device is the only authorized method to secure the detainee to the vehicle.

- Ensure that detainees are secured with seat belts on aircraft or restrained according to instructions from the flight commander.
- Do not daisy-chain (chaining two or more detainees together in a serial configuration)detainees.
- Do not use the following to control detainees:
 - Leashes.
 - Hoods.

Note. Blindfolds should be limited to situations requiring operations security. Blindfolds may include goggles; sleep masks; or a soft, clean cloth fastened around the head.

- Chains to chain a detainee against the floor, wall, or other structure.
- Stress positions (to restrain a person in a purposefully uncomfortable, awkward, or unnatural position).
- Restraints as a form of punishment or retribution.

5-99. Commanders at all echelons should establish requirements to document the circumstances that required restraints, the type of restraints used, and the length of time the restraints were used during the use of force. This information should be kept in the detainee's disciplinary record. Medical personnel are required to monitor the frequency and consequences when restraints are applied to detainees during the use of force (for example, during forced cell extraction or while using a restraint chair).

RULES FOR THE USE OF FORCE AND RULES OF ENGAGEMENT

5-100. Military police commanders ensure that Soldiers understand the RUF and ROE established by higher headquarters for their particular mission. Because the RUF and ROE vary depending on the types of detainees and the specific OE, the military police commander develops or adjusts existing SOPs to follow the guidance that has been provided. The military police commander must balance the physical security of the facility with mission accomplishment and the protection of deployed U.S. armed forces. (See appendix G.)

5-101. Restrictions on combat operations and the use of force must be clearly explained in the RUF and understood and obeyed at all levels. Soldiers study the RUF, are trained in the use of force, and are checked by their leaders to ensure that they understand the guidance for the use of force for their mission.

TRAINING

5-102. Individual and collective training are the key ingredients that build and sustain Soldier confidence and unit cohesion. As much as practicable, rigorous MI and military police collective training is conducted to replicate the detainee operations environment. Training for receiving and processing detainees should include, but is not limited to—

- Humane treatment of detainees according to the Geneva Conventions, the law of war, and U.S. policies.
- The “5 Ss and T” technique of processing.
- Procedures for securing all documents, maps, overlays, unusual equipment, or other items of potential intelligence value and accounting for them on the detainee's DD Form 2745.
- Procedures for conducting a search of the detainee before and after every movement from one location to another.
- Procedures for reporting suspicious and/or unusual behavior or activities by an individual or groups of individuals (such as passive resistance and/or not getting frustrated or angry) through the chain of command.
- Procedures for identifying English-speaking detainees and reporting them to MI personnel when in a non-English-speaking country.
- Principles of the law of war, FM 27-10, the Geneva Conventions, UN conventions, and foreign national laws and customs.
- Supervisory and human relations techniques.
- Methods of self-defense.
- RUF, ROE, and rules of interaction (ROI).
- Firearms qualification and familiarization.
- Public relations.
- First aid.
- Stress management techniques.
- Facility regulations and SOPs.
- Intelligence and counterintelligence techniques.

- Cultural customs and habits of detainees.
- Simple training in the language of detainees.
- Training in NLWs.
- Training focused on the specific application of counterinsurgency operations, to include—
 - Counterinsurgency fundamentals.
 - Counterinsurgency as it affects detention operations.
 - Intelligence preparation of the battlefield and the linkage of police intelligence operations to that process.

STANDING OPERATING PROCEDURES

5-103. Detainee operations require comprehensive SOPs that address specific requirements from the POC to the TIF. SOPs should include, but are not limited to—

- Establishment of a DCP, DHA, or TIF.
- “5 Ss and T” technique of processing.
- Detainee security escort procedures.
- ROE and/or RUF.
- Detainee policies.
- Quick-reference cards.
- Application and use of miscellaneous rules and forms. (See appendix G.)
- Roles and responsibilities for support functions, to include:
 - Custodial care.
 - Interrogation.
 - Medical.
 - Legal.
 - Interpreter.
 - Contractor.
 - CA.
 - PSYOP.
 - Emergency services.
 - Mail and postal.
- Detainee files documentation and access (such as personnel, intelligence, investigative, and medical files).
- Detainee Reporting System database maintenance and biometrics use.
- Property and evidence custody and accountability.
- Establishment of multifunctional boards with representation from military police, MI, SJA, medical personnel, NGOs, and/or the HN as appropriate. The multifunctional board SOP should contain procedures for adjudicating relevant detainee matters that include, but are not limited to, procedures for—
 - Transfer of custody.
 - Release or detain decisions.
 - Tribunals.
 - Judicial proceedings.
 - Adjudication for violations occurring within the facility.
 - Changes in ROE.
 - Repatriation.
- Changes in detainee management (compliance measures such as behavioral modification, disciplinary actions, segregation, restraints, and rewards programs).

- Integration of new technologies (new restraints, behavioral control techniques, search tools, and equipment training).
- Community relations.
- Media considerations.
- ICRC and NGO communications.
- Lock and key control.
- Badge access.
- Work orders.
- TIF control center operations.
- Intelligence collection plan.
- Entry control.
- Guard force procedures, to include—
 - Guard force rotation.
 - Cell extractions and/or sorting procedures.
 - Inter-facility and intrafacility escorts.
 - Alarm responses.
 - Roving guards.
- Compound control teams.
- MWDs.
- Detainee movement, such as—
 - Detainee sick call and/or medical care.
 - Interrogation.
- Appropriate use of segregation, restraints, blindfolds, and muffles.
- Methods of communicating Geneva Convention protections and detainee rules.
- Detainee feeding and hydration (caloric intake, culturally sensitive foods).
- Detainee head count and ISN verification.
- Facility and/or cell shakedowns (to search for weapons or contraband).
- Detainee death and burial procedures.
- Inspection of materials entering and exiting the DCP, DHA, compounds, and cells.
- Destruction procedures for confiscated items and weapons that pose a risk.
- Recurring inspections and/or inventories (recurring procedures for document disposition, alarm checks, property accountability, safety).
- Special housing units for disciplinary actions, protective custody, or special needs.
- Suicide risks.
- NLWs use.
- Quick-reaction forces and/or backup forces.
- Contingency response procedures for—
 - Escape attempts.
 - Detainee disturbances and/or riots.
 - Detainee-on-detainee violence or attempted suicide.
 - Uncooperative detainees.
 - Medical emergencies.
 - Hunger strikes.
 - Area and/or facility fires and evacuation.
 - Weather and/or limited-visibility conditions (dust storms, fog, hurricanes).
 - External attacks or other threats.

- Crime scenes (murders, suicides, undetermined deaths).
- Allegations or suspicions of detainee abuse.
- Serious incident reporting.
- Detainee social, intellectual, and religious activities as deemed appropriate by the commander.
- Detainee visitation program.
- Detainee correspondence program.
- Detainee special programs (educational, religious, recreational, safety, agricultural, employment).
- Detainee work programs, including—
 - Employment restrictions.
 - Disability compensation.
 - Rules and procedures for contract employment.
 - Employment and compensation of EPWs.
- Canteen operations.
- TIF operations training, including—
 - An introduction to detainee operations.
 - Communication with detainees (cultural awareness).
 - An introduction to the Geneva Conventions and U.S. policies on the humane treatment of detainees.
 - Familiarization with stress management procedures.
 - An introduction to HIV and universal precautions to take with HIV-positive detainees.
 - Advanced use-of-force criteria for I/R and interrogation operations.
 - An introduction to frisk, cell, and area search procedures.
 - Restraint application.
 - Personal safety awareness.
 - Defensive tactics.
 - Forced cell move procedures.
 - Response procedures for bombs and/or bomb threats.
 - Emergency procedures for fires, escapes, and disorders.
 - Cell block operations.
 - An introduction to accountability procedures.
 - Security and control activities.
 - Familiarization with special compound operations.
 - An introduction to main gate operations.
 - Visitation operations.

Chapter 6

Detainee Facilities

Detainee facilities, an important planning consideration, are treated in the same basic fashion as any base camps. The same basic planning considerations are taken into account. Some detainee facilities will be subordinate to a larger base camp but they may also be at a separate location. While the basic planning criterion for all base camps are valid for detainee facilities, there are specialized considerations that must be added to those baseline criterion. This chapter highlights some of the critical considerations for planning, constructing, and operating detainee facilities. (For more on the construction of detainee facilities, see Engineer Publication [EP] 1105-3.1, FM 3-34.400, and JP 3-34.)

GENERAL CONSIDERATIONS

6-1. The military police staff should plan the expeditious construction of facility requirements that are considered shortfalls, such as those facilities that cannot be resourced from existing assets. In these circumstances, the appropriate service, HN, alliance, or coalition should perform construction during peacetime to the extent possible. Contracting support should be used to augment military capabilities. If time constraints prevent new construction from being finished in time to meet mission requirements, the PM (in conjunction with the engineer coordinator) should seek alternative solutions. Expedient construction (rapid construction techniques such as prefabricated buildings or clamshell structures) should also be considered since these methods can be selectively employed with minimum time, cost, and risk.

6-2. The combatant commander specifies the construction standards for facilities in the theater to optimize the effort expended on any given facility, while ensuring that the facilities are adequate for health, safety, and mission accomplishment. Figure 6-1, page 6-2, shows the bed-down and basing continuum that is used to describe the standard of facilities that will be constructed to support operational needs, and it highlights the requirement for early master planning efforts to facilitate transition to more permanent facilities as an operation develops.

6-3. The combatant commander determines what facilities are needed to satisfy operational requirements. Facilities are grouped into six broad categories that emphasize the use of existing assets over new construction. To the maximum extent possible, facilities or real estate requirements should be met from these categories in the following order of priority:

- U.S.-owned, -occupied or -leased facilities (including captured facilities).
- U.S.-owned facility substitutes, pre-positioned in the theater.
- HN, multinational support where an agreement exists for the HN, multinational nations to provide specific types and quantities of facilities at specified times, in designated locations.
- Facilities available from commercial sources.
- U.S.-owned facility substitutes stored in the United States.
- Construction of facilities that are considered shortfall after an assessment of the availability of existing assets.

6-4. Figure 6-1 highlights the basic continuum that is used to determine the standard of facility that will be constructed to support operational needs. The actual determination will be made by the combatant commander who is responsible for the operational area where the construction will occur.

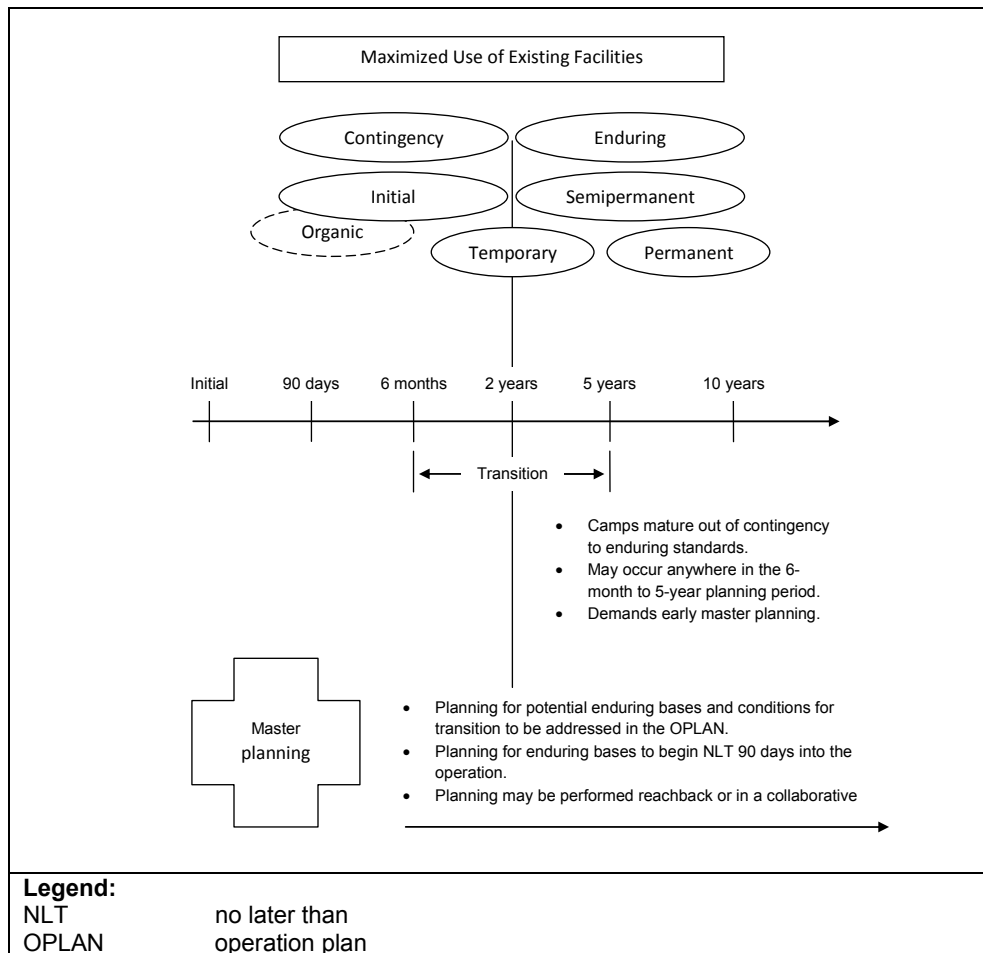

Figure 6-1. Bed-down and basing continuum

SITE PLANNING AND SELECTION

6-5. The combatant commander must consider a plan for detainee operations and the construction of facilities early in the operational plan. This provides the timely notification of engineers, selection and development of facility sites, and procurement of construction materials. Military police coordinate the location with engineers, sustainment units, higher headquarters, and the HN. The command should analyze the wide array of logistical and operational requirements that will be necessary to conduct detainee operations. The first requirement is to ensure that the correct number and type of personnel and construction material are on the ground, well in advance of the start of hostilities, to conduct the operation. The second requirement is to identify, collect, and execute a logistics plan that will support detainee operations throughout the joint operations area. The failure to properly consider and correctly evaluate all factors may increase the logistics and personnel efforts required. If an I/R facility is improperly located, the entire internee population may require relocation when resources are scarce. When selecting a site for a facility, considerations include—

- Locations where detainee labor can most effectively be used.
- Distance from other elements from which additional external security could be drawn upon if required.
- Potential threats from the internee population to logistics operations in the proposed location.
- Threat and boldness of guerrilla activity in the area.
- Attitude of the local civilian population.

- Accessibility to support forces and transportation to the site for support elements.
- Proximity to probable target areas (airfields, ammunition storage).
- Classification of internees to be housed at the site.
- Type of terrain surrounding the site and its conduciveness to escape.
- Distance from the main supply route to the source of sustainment support.
- Mission variables.
- Availability of suitable existing facilities (to avoid unnecessary construction).
- Presence of swamps, vectors, and other factors (water drainage) that affect human health.
- Existence of an adequate, satisfactory source of potable water. (The supply should meet the demands for consumption, food sanitation, and personal hygiene.)
- Availability of electricity (portable generators can be used as standby and emergency sources of electricity).
- Distance to work if internees are employed outside the facility.
- Availability of construction material.
- Soil drainage.
- Health protection for detainees and forces manning the site.
- Other environmental considerations as appropriate.

6-6. Detainee facilities must also include structural features conducive to humane treatment. Features may include—

- Adequate room to lie down and stand up without touching the walls.
- Ceiling.
- Proper ventilation.
- Sufficient lighting.
- Protection from the elements.
- Proper cover in case of a direct or indirect attack.
- Security structure capabilities.
- Medical support capabilities, to include a special management unit/area (see appendix I).
- Food and potable water availability.
- Field sanitation (latrine) facilities.
- Locations to process detainees.
- Tactical questioning or interrogation locations.
- Custodial care (feeding, hydration) locations and capabilities.
- Class I storage (dry and refrigeration).
- Tribunal tent/building.
- Visitation area.
- Guard operations area.

6-7. The type of construction necessary depends on the climate, anticipated permanency of the facility, number of facilities to be established, availability of labor and materials, and conditions under which the detaining power billets its forces in the area. Use local, vacant buildings if this is viable to reduce the requirements for engineer construction materials and personnel. Use detainees and local sources of materials to modify and construct structures as appropriate. In the absence of existing structures, tents are the most practical means for housing detainees. The U.S. Army Corps of Engineers Theater Construction Management System contains basic plans, specifications, and material requirements for detainee facilities based on the anticipated detainee population. The plans can easily be modified for temperate, frigid, tropic, and desert climates. The Theater Construction Management System also provides specifications and material requirements for the facilities when the dimensions and/or population requirements are supplied. The standard for facilities is to provide quarters as favorable as those provided for U.S. forces, making allowances for the habits and customs of the detainees. At no time should the facilities prejudice the health or safety of detainees.

- 6-8. When constructing a facility, planning considerations may include, but are not limited to—
- **Clear zones.** As appropriate, mission variables determine the clear zone surrounding each facility that houses detainees. Construct at least two fences (interior and exterior) around the detainee facility and ensure that the clear zone between the interior and exterior fences is free of vegetation and shrubbery.
 - **Guard towers.** Locate guard towers on the perimeter of each facility. Place them immediately outside the wall or, in case of double fencing, where they permit an unobstructed view of the lane between the fences. The space between towers must allow overlapping observation and fields of fire. During adverse weather, it may be necessary to augment security by placing fixed guard posts between towers on the outside of the fence. Towers must be high enough to allow an unobstructed view of the compound and low enough to permit an adequate field of fire. The tower platform should have retractable ladders and should be wide enough to mount crew-served weapons. Another consideration involves using nonlethal capabilities from guard towers.
 - **Lights.** Provide adequate lighting, especially around compound perimeters. Illuminating walls and fences discourages escapes, and illuminating inner strategic points expedites the handling of problems caused by detainees. Lights should be protected from breakage with an unbreakable glass shield or a wire mesh screen. Ensure that lights on the walls and fences do not interfere with the guards' vision. Provide secondary emergency lighting.
 - **Patrol roads.** Construct patrol roads for vehicle and foot patrols. They should be adjacent to outside perimeter fences or walls.
 - **Sally ports.** A sally port is required to search vehicles and personnel entering and leaving the main compound. It is recommended that a sally port be placed at the back entrance to the facility.
 - **Communications.** Ensure that communication between the towers and the operation headquarters is reliable. Telephones are the preferred method; however, ensure that alternate forms of communication (radio and visual or sound signals) are available if telephones are inoperable.
- 6-9. The facility layout depends on the nature of the operation, terrain, building materials, and HN support. Each facility should contain—
- Barracks (may be general-purpose medium tents in the early stages of an operation).
 - Kitchen and dining facilities.
 - Bath houses.
 - Latrines.
 - Recreation areas.
 - Chapel facilities.
 - Administrative areas with a command post, an administrative building, an interrogation facility, a dispensary, an infirmary, a mortuary, and a supply building.
 - Receiving and processing centers.
 - Maximum security areas with individual cells.
 - Parking areas.
 - Trash collection points.
 - Potable water points.
 - Storage areas.
 - Hazardous materials storage areas.
 - Generator and fuel areas.

DETAINEE COLLECTION POINT

6-10. DCPs are generally nothing more than a guarded, roped-off (with razor or concertina wire) area or a secured building (see figure 6-2). The capture rate and the number of detainees determine the size of the DCP. The use of existing structures (vacant schools, apartments, warehouses) is encouraged to conserve

resources and provide protection for detainees. Detainees are treated humanely and as EPWs until their status is determined according to DOD policy. Detainees are held at the DCP until transportation becomes available to take them to a safer area (a DHA or TIF). MI exploitation may begin at the DCP and continue at the DHA and TIF until the detainee is released or the intelligence value of the detainee has been exhausted.

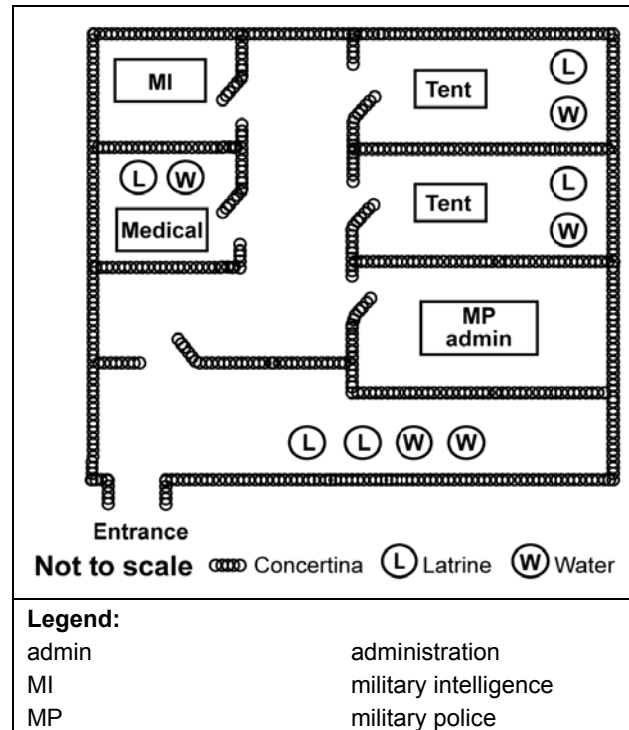

Figure 6-2. Example of a DCP layout

6-11. Organic or task-organized military police platoons or companies within the BCT may be directed to set up and operate a DCP. DCPs are needed when the BCT is likely to take detainees. The BCT PM develops and provides technical guidance over the military police platoon or company operating the DCP. (See figure 6-3, page 6-6.) Medical, HUMINT, and counterintelligence assets operating within the DCP are typically under the tactical control of the military police platoon or company operating the DCP.

6-12. The number of military police teams or units needed to operate a DCP is based on the number of detainees expected and other mission variables. The projected number of detainees is based on mission analysis and intelligence estimates. DCPs are mobile and can be set up quickly, expanded, and relocated as the tactical situation dictates. Detainees will be held at the DCP until MI exploitation has been exhausted and transportation becomes available for the release or transfer to the DHA or, in some cases, directly to the TIF. The DCP is the second point at which a decision is made to retain or release a detainee.

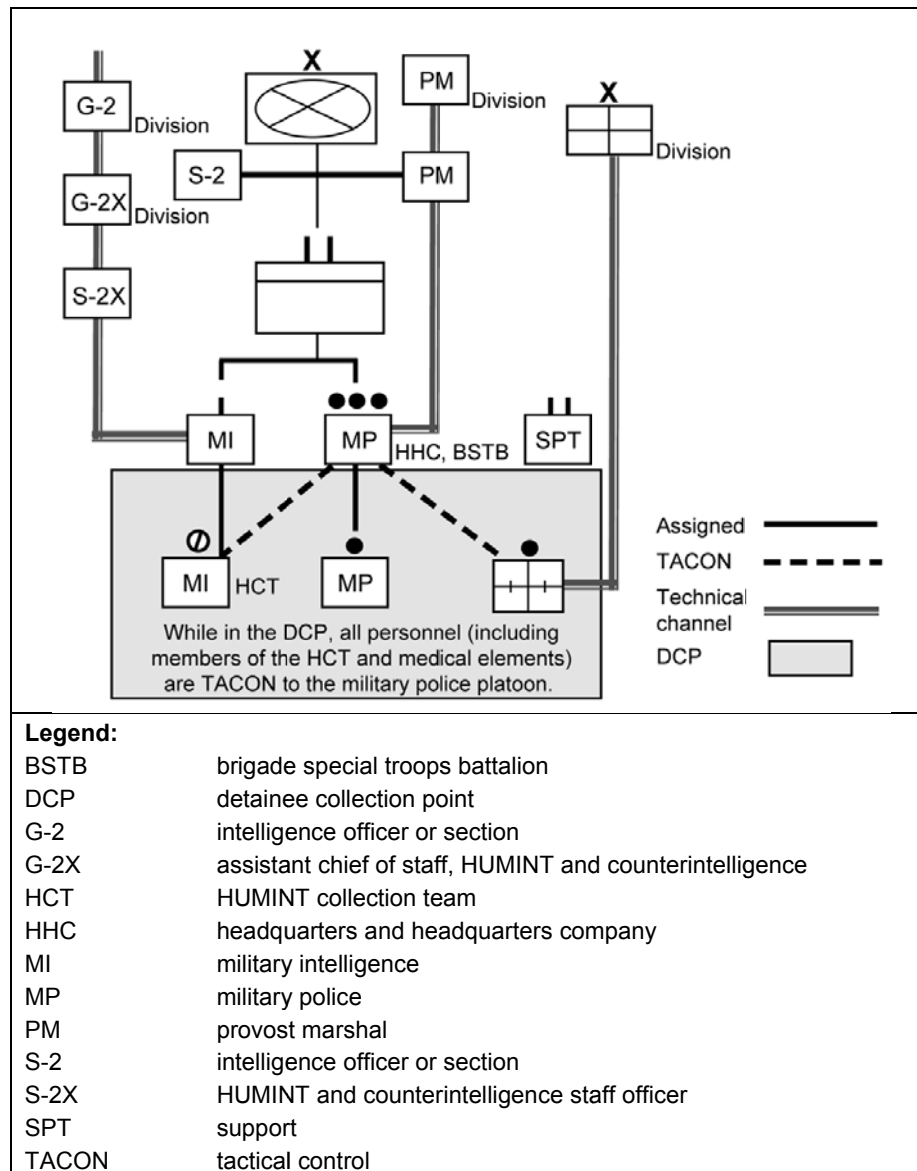

Figure 6-3. C2 within the BCT and the DCP

LOCATION

6-13. The general location of a DCP is normally identified in the operation plan or order. The DCP should typically be located near or in the BCT support area. It is normally located in an area that prevents detainees from observing activities within the BCT support area. A DCP located close to the main supply route makes detainee delivery and evacuation easier. A DCP may also be established where actual combat operations are occurring. For example, during a cordon-and-search operation, the military police platoon may establish a DCP near the cordon area. During long-term stability operations (especially those conducted in a counterinsurgency environment), multiple DCPs may need to be placed across the BCT AO (to include within subordinate battalion AOs). A DCP is seldom set up near the indigenous population to prevent problems caused by the presence of detainees in the area. When selecting a DCP, consider shelter availability and cover capabilities.

Note. Detainees can dig or build cover to protect themselves from direct and indirect fire.

DETAINEE PROCESSING

6-14. When detainees arrive at the DCP, military police use the following procedures to process them and their possessions:

- **Search.** Searching includes those actions taken to neutralize a detainee and confiscate weapons, personal items, and items of potential intelligence and/or evidentiary value.

Note. Conduct same-gender searches when possible. If mixed-gender searches are necessary for speed and security, conduct them in a respectful manner and in the presence of an additional witness to address claims of misconduct.

- **Tag.** Tagging ensures that each detainee is properly accounted for using a DD Form 2745. If the detainees were not tagged at the POC, tag each detainee using a DD Form 2745. Each DD Form 2745 has a unique number. The DD Form 2745 number is the official detainee tracking number before detainees receive an ISN. The DA Form 4137, used to document confiscated items, will be linked to the detainee by annotating the DD Form 2745 number on the form.
- **Report.** Reporting the number of detainees helps to accurately determine transportation and security requirements. Report the number of detainees to the local military police support assets by their DD Form 2745 numbers. These support assets will assist with planning transportation, escort security, and resource requirements. Also, report all allegations of mistreatment or detainee abuse.
- **Evacuate.** Evacuating detainees moves them from the continuing risks associated with other combatants or sympathizers who may still be in the area of capture. If there are too many detainees to control, call for additional support, search them, and hold them in place until reinforcements arrive. Expedite the evacuation of detainees from the DCP to the DHA or from the DHA to the TIF according to military policy. A convoy escort will be planned based on a risk assessment of each detainee's status, security, and resource requirements. Ensure that detainees are accounted for by comparing their DD Form 2745 number against the manifest before and after each convoy operation. Evacuate detainees and confiscated items together.
- **Segregate.** Segregating detainees should be done according to policy and SOPs. Segregation requirements differ from operation to operation. The ability to segregate detainees may be limited by the availability of manpower and resources. MI personnel and military police can provide additional guidance and support in determining appropriate segregation criteria. Establish and maintain segregation based on mission variables. Within the DCP, detainees are further segregated into the following categories:
 - Leaders (perceived status and positions of authority).
 - Hostile elements (hostile religious, political, ethnic groups).
 - Security risks (agitators, radicals, uncooperative detainees).
 - Civilian.
 - Military.
 - Military by grade (officers, NCOs, enlisted).
 - Deserters. Those who surrendered from those who resisted capture.
 - Minors.
 - Females (if possible, keep small children with their mothers).
 - Males.
 - Groups of CIs, RP, and enemy combatants if known.
 - Nationality.
 - Suspected criminals.
 - Other persons (those not in one of the above categories).
- **Safeguard.** Safeguarding is the obligation to protect detainee safety and ensure the custody and integrity of confiscated items. Soldiers must safeguard detainees from combat risk, harm caused

by other detainees, and improper treatment or care. All detainees are presumed to be EPWs at this stage after capture. The GPW requires that EPWs and other detainees be respected and protected from harm. Report all injuries. Correct and report violations of U.S. military policy that occur while safeguarding detainees. Acts and/or omissions that constitute inhumane treatment are violations of the law of war and, as such, must be corrected immediately. Simply reporting violations is insufficient. If a violation is ongoing, a Soldier has an obligation to stop the violation and report it.

6-15. Military police at a DCP ensure that a DD Form 2745 is attached to detainees arriving without them. Capturing units may need to be directed to complete DD Forms 2745 before detainees are accepted into the DCP. Military police must ensure that each DD Form 2745 is complete and attached to the correct detainee. Criminal prosecution of a detainee depends on collected evidence and statements. Military police must—

- Complete DD Form 2745 with at least the minimum information listed (also listed on the back of Part C of the form).
- Make a statement on DA Form 2823 if the detainee arrived without an attached DD Form 2745.
- Instruct the detainee not to remove or alter the attached DD Form 2745.
- Annotate the DD Form 2745 number and the detainee's name on a manifest.
- Identify and ensure that supplemental forms are processed with DD Form 2745.

6-16. Military police must not speak to detainees except to give orders or directions. Do not let detainees talk to or signal each other during the processing phase at any echelon. This prevents them from plotting ways to counter security, planning escapes, or orchestrating other undesirable activities. Detainees who refuse to be silent may require a muffle (an item used to prevent speech or outcry without causing injury to the detainee, such as cloth) in certain tactical situations.

DANGER

Use a muffle only as long as needed, and ensure that the muffle does not harm the individual.

6-17. Safeguard detainees from obvious targets such as ammunition sites, fuel facilities, or communications equipment. To safeguard detainees according to the GWS, GPW, GC, and U.S. policies, Soldiers must—

- Provide first aid and medical treatment for wounded or sick detainees. Wounded and sick detainees are evacuated separately through medical channels using the same assets as those used to medically evacuate U.S. and multinational forces.
- Provide detainees with food and water. These supplies must be equal to those given to U.S. armed forces and multinational forces. (See FM 27-10.)
- Ensure that firm, humane treatment is given.
- Allow detainees to use their protective equipment in case of hostile fire or a CBRN threat.
- Protect detainees from abuse by anyone, including other detainees and local civilians.
- Report all acts or allegations of inhumane treatment through military police channels and immediately stop or prevent them. (See AR 190-45.)

HUMAN INTELLIGENCE SUPPORT

6-18. At DCPs, HUMINT collectors should debrief military police who are in regular contact with detainees. HUMINT collectors should coordinate this debriefing through the military police chain of command. Information collected in this manner may provide valuable insight that can aid the collector in formulating approach strategies. Military police should be debriefed in such a way that it does not interfere with their mission; this debriefing does not constitute a tasking. In the absence of HUMINT or counterintelligence assets, the intelligence staff officer, S-2/G-2, should perform this function. HUMINT liaison with the military police chain of command is vital to gain its support and ensure that HUMINT

collection will not interfere with military police operations. Joint patrols containing military police and HUMINT collectors can also be mutually beneficial in many situations.

6-19. HUMINT collectors use the biometrics automated toolset to collect biometric data for intelligence purposes during screening operations at all echelons when available. While the biometrics automated toolset is not a Detainee Reporting System accountability tool, it is used to collect much of the same data as the Detainee Reporting System.

6-20. While in the DCP, MI units are under tactical control of the military police platoon leader (or company commander). The platoon leader is the officer in charge for detainee operations and is responsible for the humane treatment, evacuation, and custody and control (reception, processing, administration, internment, and safety) of detainees; security; and the operation of the internment facility. The MI unit commander is responsible for conducting interrogation operations (including prioritizing the effort) and controlling the technical aspects of interrogation and other intelligence operations. The intelligence staff maintains control over interrogation operations through technical channels to ensure adherence to applicable laws and policies, ensure the proper use of doctrinal approaches and techniques, and provide technical guidance for interrogation activities. They receive technical guidance and priorities from the operational management team or G-2X. The military police platoon leader will not establish intelligence priorities for HUMINT or counterintelligence personnel. HUMINT and counterintelligence personnel should only remain involved with activities that concern intelligence gathering, unless their involvement is necessary to ensure the humane treatment or security of detainees.

MEDICAL SUPPORT

6-21. Medical care at the DCP is provided according to necessity and limited to emergency medical care only. Medical personnel assigned to the military police unit normally treat detainees at the DCP. Detainees requiring more than first aid, combat lifesaver, or Level I medical care are transported to a location where they can receive the appropriate level of care. The BCT PM and/or military police platoon leader must coordinate with medical personnel within the BCT to ensure that proper and timely medical care for detainees is available. Moreover, military police exercise tactical control of medical personnel while operating within the DCP. (See appendix I.)

6-22. Medical personnel will promptly report suspected detainee abuse to the proper authorities as outlined in the medical policies developed for detainee operations. Generally, information pertaining to medical conditions and the care provided to patients, including medical care for detainees, is handled with respect to patient privacy. Under U.S. and international laws, there is no absolute confidentiality of medical information for any person, including detainees.

SECURITY CONSIDERATIONS

6-23. The DCP is normally located within the brigade footprint. Therefore, military police should thoroughly brief the units in the brigade on the location of the DCP and recommended actions to take in the event of a detainee escape. Additional security measures to implement at the DCP include—

- The presence of an enhanced guard force when detainees are inprocessed, outprocessed, medically examined, and in the custody of HUMINT collectors.
- The use of MWDs as a show of force and to deter escape attempts.

WARNING

MWDs will not be used to intimidate detainees or take part in interrogation operations.

DETAINEE HOLDING AREA

6-24. A DHA is a temporary location used to field-process and house detainees and provide resources for intelligence exploitation. It generally consists of a semipermanent structure that is designed and resourced to house detainees. (See figure 6-4.) Basic infrastructure elements include shelter and/or cover, latrines, basic hygiene facilities, and medical care.

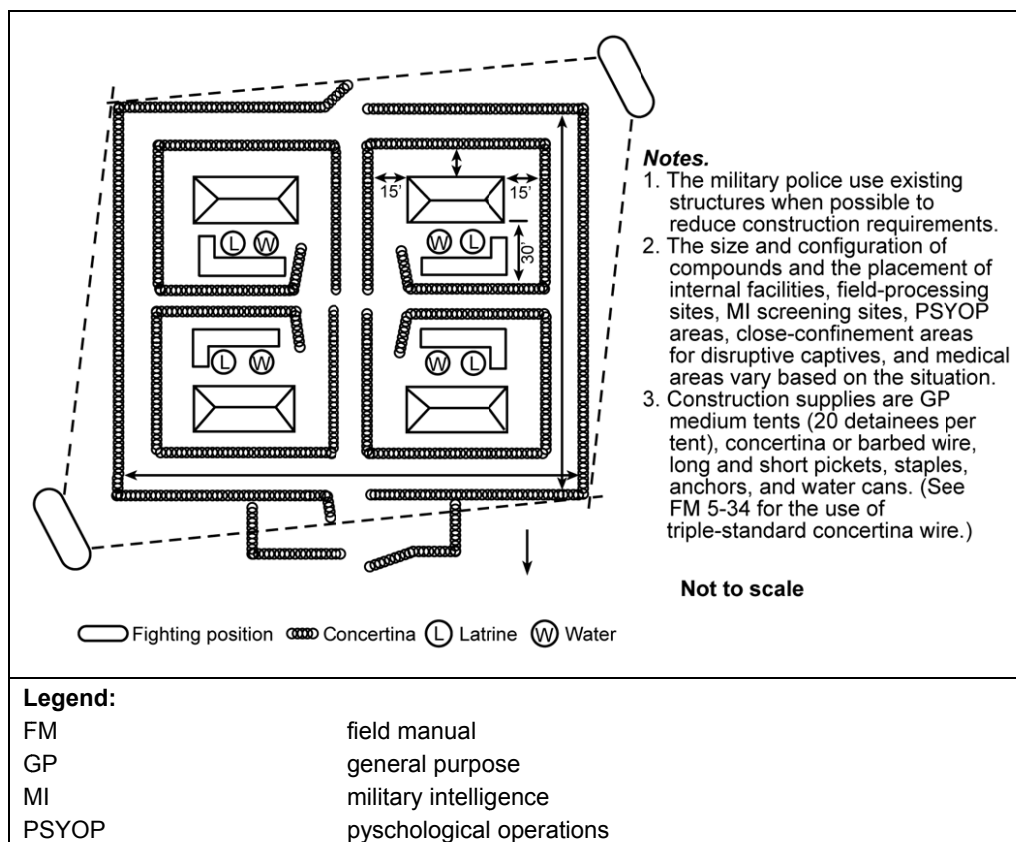

Figure 6-4. Example of a DHA

6-25. Military police assigned to the military police brigade, or possibly the MEB, operate the DHA. (See figure 6-5.) The primary units operating a DHA may include a variety of military police units under the C2 of an I/R or military police battalion. (See appendix B.)

6-26. Military police, MI, medical, and legal assets (typically colocated) at the DHA should provide tactical interrogation and HUMINT/counterintelligence screening.

6-27. Detainees are treated as EPWs until their status is determined according to DOD policy. HUMINT collectors are normally available at the DHA to support this determination. Detainees will be held at the DHA until transportation becomes available to take them to a safer area (another DHA or TIF). MI exploitation may begin at the DCP. MI exploitation continues at the DHA until the detainee is released, moved to a TIF, or is no longer of intelligence value. The DHA is the third point within the hierarchy of sites at which a decision is made to detain or release a detainee.

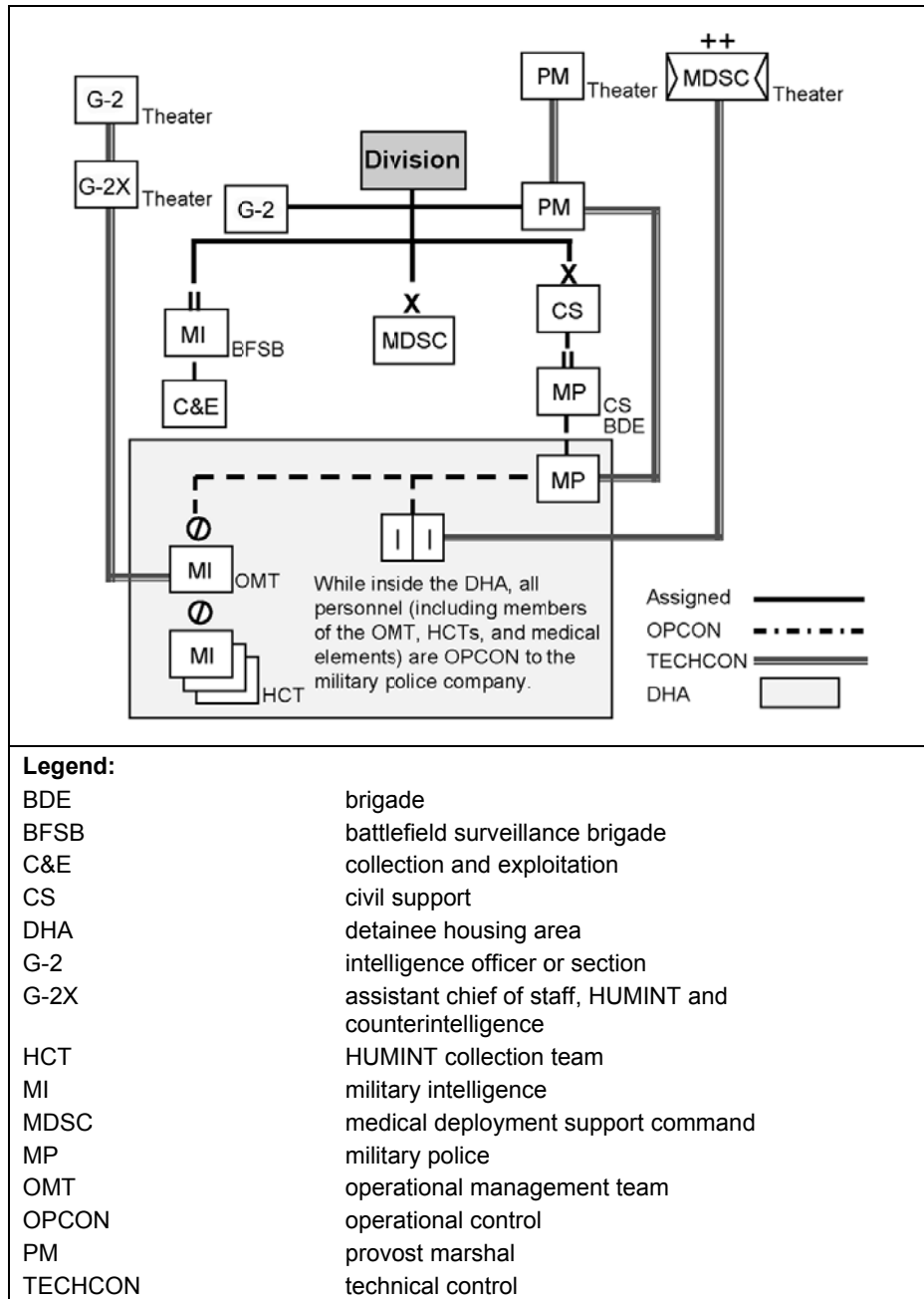

Figure 6-5. C2 within the division and DHA

LOCATION

6-28. The DHA is established with the division’s AO. The best location may be within the MEB AO if one is present in the division AO. The DHA is normally located in a safe, and secure area that is accessible for the receipt, care, and evacuation of detainees. During long-term stability operations, especially those conducted in a counterinsurgency environment, multiple DHAs placed across the division AO (to include within subordinate BCT AOs) may be required. DHAs should be established adjacent to main transportation arteries that expedite further movement of personnel and sustainment requirements.

ADDITIONAL PLANNING CONSIDERATIONS

6-29. When establishing a DHA or expanding a DCP to provide extended detainee processing and housing, commanders must consider design options, including—

- Building an outer perimeter using an earthen berm, fence, or rolled concertina or razor wire to contain the operation.
- Providing the following secure areas:
 - An entry point (with double barriers) into the DCP and/or DHA.
 - A reception area for custody transfer operations.
 - An administrative area.
 - A medical support area.
 - An interrogation area and/or facility.
 - A centralized property room (for evidence, found property, and confiscated property).
 - Open compounds for housing multiple detainees by segregation designation.
 - Single-cell units for disciplinary segregation.
- Establishing small compounds for segregation. The compound design should include the following, depending on the availability of resources:
 - Towers or other fixed locations that provide for mutual support.
 - Shelters within each compound if detainees are being housed there. (Hard facilities are preferred, but tents are the minimum requirement.)
 - Communications between towers and adjacent compounds.
 - Lights that are capable of illuminating and flooding compounds.
 - Compounds that are free of rocks and other debris.
 - Latrines and personal hygiene points that are separate from detainee living areas, but with easy access from the compounds.
- Developing individual cells or confinement spaces to provide additional segregation for violent or uncooperative detainees, high-value detainees, or detainees who are vulnerable to harm by other detainees as the situation allows.

6-30. The commander must—

- Stock appropriate cleaning supplies to sanitize areas and/or facilities.
- Provide adequate clothing and footwear.
- Provide three adequate meals and sufficient hydration daily to maintain good health.
- Provide appropriate medical care and preventive medicine as available.
- Post information on the applicable protections afforded under the Geneva Conventions and detainee rules in the local language. (This information should be posted in a conspicuous location.)

6-31. A sufficient guard force should be established based on the location and facility structural design, number of detainees, segregation requirements, and detainee threat and risk levels. Accordingly, a guard force should consist of, at a minimum, a sergeant of the guard, tower and static guards, roving guards, escort guards, and a reaction force.

6-32. When conducting HUMINT collection in the DHA, military police should—

- Locate the site where screeners can observe detainees as they are segregated and processed. It should be shielded from the direct view of the detainee population and far enough away so that detainees cannot overhear screeners' conversations.
- Select a site that will accommodate operation, administrative, and interrogation areas. Lights should be made available for night operations.
- Ensure that guards are available and that procedures for escorting and securing detainees during the interrogation process are outlined in the SOP.

- Notify screeners about any detainees that will be moved and when they will be moved.
- Ensure that accountability procedures are implemented and that the required forms are available.

6-33. Military police operating the DHA have tactical control over HUMINT collectors, medical personnel, and other personnel who operate inside the DHA and are responsible for the humane treatment, evacuation, custody, and control (reception, processing, administration, internment, and safety) of detainees; security; and the operation of the internment facility. For HUMINT support at the DHA, the MI unit commander is responsible for conducting interrogation operations (including prioritizing the effort) and controlling the technical aspects of interrogation and other intelligence operations. The intelligence staff maintains control through technical channels over interrogation operations to ensure adherence to applicable laws and policies, ensure the proper use of doctrinal approaches and techniques, and provide technical guidance for interrogation activities. Applicable laws and policies include U.S. laws, the law of war, relevant international laws, relevant directives (including DODD 2310.01E and DODD 3115.09), DODIs, execution orders, and FRAGOs. The military police company or battalion commander will not establish intelligence priorities for HUMINT and/or counterintelligence personnel, nor should the military police commander compel HUMINT and/or counterintelligence personnel to involve themselves in nonintelligence activities. The detainee operations medical director is designated by the medical deployment support command commander to provide technical guidance for the medical aspects of detainee operations conducted throughout the joint operations area.

HUMAN INTELLIGENCE SUPPORT

6-34. To facilitate collecting enemy tactical information, MI personnel may collocate HUMINT and counterintelligence teams at the DHA to screen arriving detainees and determine which of them are of immediate tactical intelligence value to the maneuver commander. This provides MI personnel with direct access to detainees and their equipment and documents. Military police and MI personnel coordinate to establish operating procedures that include the accountability of detainees. An interrogation area is established away from the receiving and processing line so that MI personnel can interrogate detainees and examine their equipment and documents. If a detainee or the detainee's equipment and/or documents are removed from the receiving and processing line, they are accounted for on DA Form 4137 and DD Form 2708.

6-35. HUMINT collectors screen detainees at the DHA by observing them from an area close to the dismount point or processing area, looking for anyone who is a potential source of tactical and operational information. As each detainee passes, MI personnel examine the DD Form 2745 and look for branch insignias or other clues which indicate that a detainee has information to support command priority intelligence and information requirements. They also look for detainees who are willing or attempting to talk to guards; intentionally joining the wrong group; or displaying signs of nervousness, anxiety, or fear.

6-36. Military police assist the HUMINT collectors by identifying detainees who may have answers that support priority intelligence and information requirements. Because military police are in constant contact with detainees, they see how certain detainees respond to orders and see the types of requests that are made. The military police ensure that searches requested by MI personnel are conducted out of the sight of other detainees and that guards conduct same-gender searches when possible.

6-37. MI screeners examine captured documents, equipment, and, in some cases, personal papers (journals, diaries, letters). They look for information that identifies a detainee and the detainee's organization, mission, and personal background (family, knowledge, experience). The knowledge of a detainee's physical and emotional status or other information helps screeners determine the detainee's willingness to cooperate.

6-38. HUMINT collectors at the DHA provide input to assist in the decision to release or detain an individual. If the decision is made to detain the individual, arrangements are then made to transport the detainee to a TIF for formal processing into the Detainee Reporting System, including the issuance of an ISN.

MEDICAL SUPPORT

6-39. Medical personnel organic to maneuver units or the brigade support medical company may be required to provide emergency medical treatment or evacuation on an area support basis at a DHA. (See appendix I.)

6-40. The medical screening that can be accomplished at a DHA is limited. The purpose of this medical screening is to ensure that the detainees do not have significant wounds, injuries, or other medical conditions (such as severe dehydration) that require immediate medical attention and/or evacuation. Medical personnel screen for conditions that could deteriorate before transfer to a TIF. This screening does not include the use of diagnostic equipment, such as X rays or laboratory tests, because these resources are not available at a DCP or DHA. Any injuries or medical treatment provided during screening is entered on the DD Form 1380. The detainee's DD Form 2745 number is used as the identification number on the DD Form 1380. If the detainee is not to be evacuated through medical channels, provide one copy of the DD Form 1380 to the detaining unit for inclusion in the detainee's medical record, which will be initiated and maintained at the TIF. When an ISN is assigned at the TIF, it will be used for detainee identification in the detainee's medical records folder.

6-41. Detainees whose medical conditions require hospitalization are treated, stabilized, and evacuated to a supporting medical treatment facility. The DD Form 1380 is sent with detainees for inclusion in their medical records, which are established at the Level III hospital.

6-42. The initial care provided to detainees at Levels I and II will be documented on DD Form 1380. Once detainees are evacuated to a higher level of care, the appropriate medical record folder containing the required demographic information will be initiated. All medical documentation and medications from screening examinations or treatment at prior locations, such as the DCP, should be available for review and inclusion in the medical record.

6-43. The DHA is a temporary holding area; however, temporary can be a relative term. If the DHA remains in the same location for an extended period, improvement to the field sanitation areas (such as latrines and showers) should be undertaken, rather than relying solely on field-expedient facilities as done at the DCP. Medical personnel and/or units could also be attached to provide an expanded sick call capability.

6-44. Inprocessing medical screenings are only conducted at the TIF. However, DHA medical personnel can document preexisting injuries with medical photography, if appropriate, and forward this documentation with the detainees for later inclusion in their medical records initiated at the TIF. At the DHA, medical encounters may be documented on SF 600. If used, forward it with detainees upon transfer to the TIF for inclusion in their medical records.

SECURITY CONSIDERATIONS

6-45. The DHA, like the DCP, is a temporary holding area for detainees. Nevertheless, the security considerations remain the same at any echelon where detainees are held. The temporary nature of the DHA does not negate the responsibility of military police and other forces to plan for and establish security. Attempted escapes and proper protective measures for the forces and detainees inside the DHA must always be prime planning considerations.

FIXED DETAINEE INTERNMENT FACILITIES

6-46. Fixed detainee internment facilities include TIF and SIF facilities, each of which encompass many regulatory and doctrinal solutions. Detainees are selectively assigned to appropriate advanced internment facilities that best meet the needs of the detaining power and the detainee. Detainees (such as enemy combatants) that hold violent opposing ideologies are interned in separate facilities in an effort to isolate them from the general population and preempt any unforeseen problems. Once they have been assigned to a facility, they may be further segregated because of nationality, language, or other reasons.

DETAINEE REPORTING SYSTEM

6-47. The Detainee Reporting System is the mandated detainee accountability database for all DOD agencies. Key functions of the Detainee Reporting System at the TIF/SIF include—

- Assigning ISNs.
- Documenting detainee transfers, releases, and repatriations.
- Recording detainee deaths.
- Recording detainee escapes.

6-48. The timely and accurate reporting of data through the Detainee Reporting System is critical to ensuring detainee accountability. As detainees are collected and processed, the Geneva Conventions require that such information be forwarded to the appropriate authorities. Failure to do so may bring unwanted scrutiny on the U.S. government for neglecting its duties under international laws.

6-49. The NDRC is designated by the OPMG to receive and archive all detainee information. The NDRC provides detainee information to the protecting power or ICRC (to fulfill U.S. obligations under the Geneva Conventions); various agencies in the DA, DOD, and Federal Bureau of Investigation (FBI); and the U.S. Congress. The NDRC's principal responsibility is to ensure the collection, storage, and appropriate dissemination of detainee information as required by AR 190-8 and DODD 2310.01E. The NDRC directs the development of a Detainee Reporting System and issues blocks of ISNs to the TDRC.

6-50. The TDRC functions as the field operations agency for the NDRC, and it reports all detainee data directly to the NDRC. The TDRC is responsible for maintaining information on all detainees and their personal property within an assigned theater of operations. It obtains and stores information concerning all detainees in the custody of U.S. armed forces (including those captured by U.S. armed forces and transferred to other powers for internment or those received from other powers for internment [temporarily or permanently]). The TDRC serves as the theater repository for information pertaining to detainee accountability and ensures the implementation of DOD policy. It provides initial blocks of ISNs and replenishes blocks of ISNs (as needed) to units performing detainee operations in the theater. The TDRC requests additional blocks of ISNs from the NDRC. The TIF requests ISNs from the TDRC and forwards all information concerning the detainees to the TDRC.

6-51. All locations to which the TDRC issues ISNs should send information concerning the detainee back to the TDRC. A detainee's ISN is used detainee's internment as the primary means of identification. It is used to link the detainee with biometric data (such as fingerprints, iris image, and DNA), personal property, medical information, and issued equipment.

INTERNMENT SERIAL NUMBERS

6-52. The ISN is the DOD-mandated identification number used to account for and/or track detainees. (See figure 6-6, page 6-16.) Once an ISN is assigned, it is used on all documentation, including medical records. The ISN is generated by the Detainee Reporting System. The Detainee Reporting System is the only approved system for maintaining detainee accountability. It is the central data point system used for reporting to the national level and sharing detainee information with other authorized agencies. ISNs are normally issued within 14 days of capture, regardless of where detainees are held, or according to applicable policy. The ISN is comprised of the—

- Capturing power (a two-digit alpha character code representing the capturing power). Only country codes found in the Defense Intelligence Agency manual (DIAM) 58-12 are used.
- Theater code (a one-digit number representing the command/theater under which the detainee came into U.S. custody).
- Power served (a two-digit alpha character code representing the detainee's power served [the country the detainee is fighting for]). Only country codes found DIAM 58-12 are used.
- Sequence number (a unique six-digit number assigned exclusively to an individual detainee). The Detainee Reporting System assigns these numbers sequentially. If a detainee dies, is released, is repatriated, is transferred, or escapes, the detainee's number is not reissued during the same conflict.

- Detainee classification (a two- or three-digit alpha character code representing the detainee's classification). Current classifications are CI, RP, and enemy combatants. Enemy combatants are further divided into EPWs and members of armed groups.

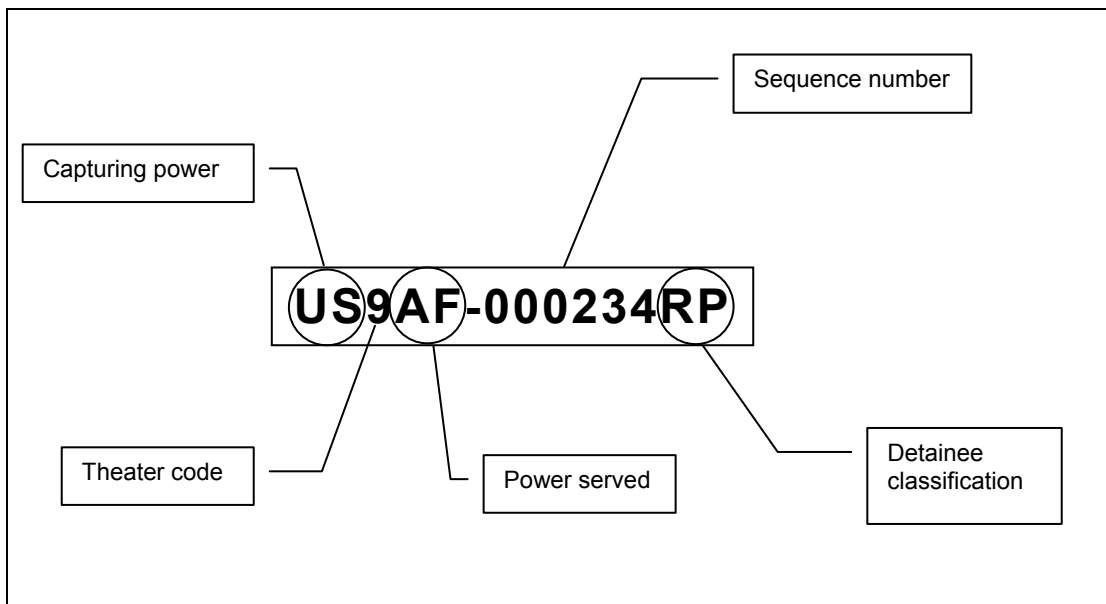

Figure 6-6. ISN

6-53. The detainee information is reported through the TDRC to the NDRC. The TDRC is normally colocated with the CDO. Once the Detainee Reporting System creates an ISN, no component may be changed or corrected at the theater level without approval from the NDRC. All changes to ISNs must be requested in writing and approved by the NDRC. U.S. armed forces must accurately account for detainees and issue ISNs when required.

6-54. When required by laws and/or policies, the NDRC provides detainee information (POC, country of origin, injury status, internment status) to the ICRC to satisfy the obligations of the Geneva Conventions. The ICRC uses this detainee information to give the detainee's status to the detainee's government. Commanders should try to standardize the tracking of detainees from the POC through the issuance of an ISN. The number found on DD Form 2745 is the only authorized tracking number that may be used before the assignment of an ISN. After an ISN is assigned, previously completed documents should be annotated with the assigned ISN. For example, medical channels should use the DD Form 2745 number at first and then use the ISN once an ISN is issued to the detainee. The Detainee Reporting System cross-references the ISN and the DD Form 2745 number for administrative purposes.

6-55. If a detainee is inadvertently issued a second ISN (clerical error, recapture) the processing personnel will contact the NDRC, which will correct the sequence. No gaps are permitted in the official records and numbering of detainees.

DETAINEE IDENTIFICATION BAND

6-56. The requirements for identifying a detainee by name and ISN are many and varied. Among the more common reasons are—

- Periodically verifying detainee rosters against the actual compound population.
- Identifying compound work details.
- Matching detainees with their individual medical records.
- Checking the identities of detainees to be transferred or released against actual transfer rosters.
- Tracking detainees through medical channels.

6-57. The detainee identification band permits the rapid and reliable identification of each detainee. Identification bands enhance facility administration and operation. The Detainee Reporting System can create identification bands that show the ISN number, name, and photo of the detainee. If the Detainee Reporting System is not available, record the detainee's ISN and last name on the identification band and secure it to the detainee's left wrist. If appropriate bands are not available, use a medical wristband or something similar.

6-58. When the identification band has serious deterioration or the ISN and name are obscured, replace it with a new one. Periodic random checks of detainee identification bands will detect fair wear and tear and any efforts to destroy the bands. When inspecting for fair wear and tear, also look for any evidence of detainees exchanging bands. Such exchanges are entirely possible and should be expected; however, the removal of an identification band by the original wearer will result in damage which is easily detected. When positive identification is essential, such as for transfer or hospitalization, examine the identification band carefully for the evidence of removal from another detainee. Additionally, conduct periodic routine inspections of randomly selected identification bands in the mess line, during compound inspections, or at other opportune times to help detect any attempt to tamper with or exchange an identification band.

THEATER INTERNMENT FACILITY

6-59. The TIF is a permanent or semipermanent facility (normally located at the theater level) that is capable of holding detainees for extended periods of time. A TIF is a long-term internment facility that is operated according to all applicable laws and policies. The JIDC is normally within the TIF. It is possible that detainees and/or enemy combatants may bypass a DCP or DHA and be transferred directly to the TIF. In such cases, all processing that would have taken place earlier must be accomplished immediately on arrival at the TIF. Military police units task organized to the I/R battalion will be based on the specific requirements of the TIF. (See appendix B.)

6-60. The TIF is the first location where detainees may be held for extended periods of time. The infrastructure and design standards associated with the TIF reflect long-term detention and facilitate and ensure humane treatment throughout a detainee's stay in the facility. (See appendix J for more information on internment facility design.)

6-61. Key organization elements in the TIF may include a joint security group, JIDC, detainee hospital, joint logistics group, joint internment operations group, CA unit, and psychological unit. Special staff considerations may include a joint visitor's bureau, chaplain, inspector general, SJA, public affairs, surgeon, forensic psychologist, forensic psychiatrist, medical plans and operations officer, environmental health officer, and PM and/or security forces.

6-62. Dedicated teams may be organized and employed to identify and mitigate threats within the facility. These teams, configured with specific capabilities based on requirements determined from current mission variables, will likely include bilingual bicultural advisors, intelligence officers, counterintelligence agents, and others as needed. The teams may be required for each major compound within the TIF or SIF.

6-63. The military police operating the TIF have tactical control over HUMINT collectors, medical personnel, and other personnel who conduct operations at the TIF for the humane treatment, evacuation, custody, and control (reception, processing, administration, internment, and safety) of detainees; security; and the operation of the internment facility. For HUMINT support at the TIF, the JIDC commander is responsible for conducting interrogation operations (including prioritization of effort) and controlling the technical aspects of interrogation or other intelligence operations. The intelligence staff maintains control over interrogation operations through technical channels to ensure adherence to applicable laws and policy, ensure the proper use of doctrinal approaches and techniques, and provide technical guidance for interrogation activities. Applicable laws and policies include U.S. laws, the law of war, relevant international laws, relevant directives (including DODD 3115.09 and DODD 2310.01E), DODIs, execution orders, and FRAGOs. The military police commander will not establish intelligence priorities for the HUMINT and/or counterintelligence personnel. HUMINT and/or counterintelligence personnel should only remain involved with activities that concern intelligence gathering. The detainee operations medical director is designated by the medical deployment support command commander to provide technical

guidance for the medical aspects of detainee operations conducted throughout the joint operations area. (See figures 6-7 and 6-8.)

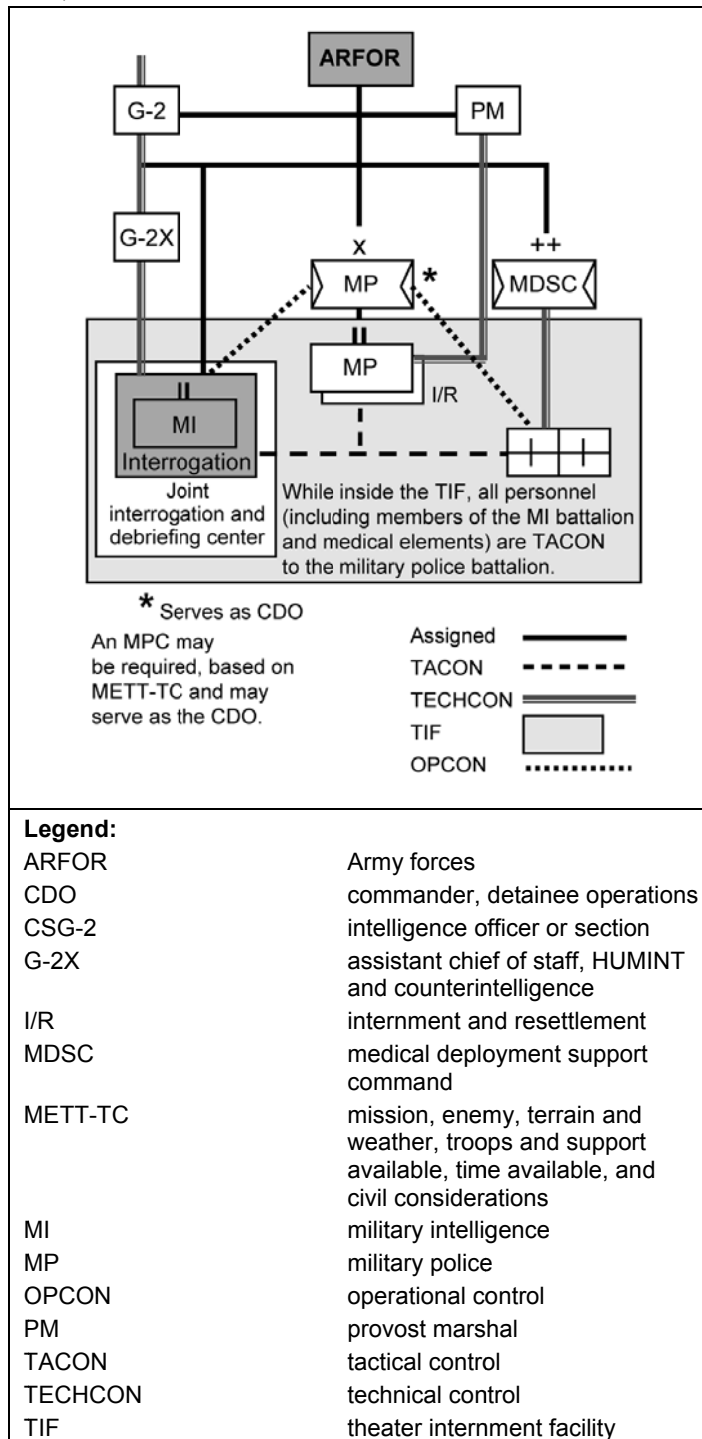

Figure 6-7. Sample TIF C2 in the theater with single or multiple small TIFs

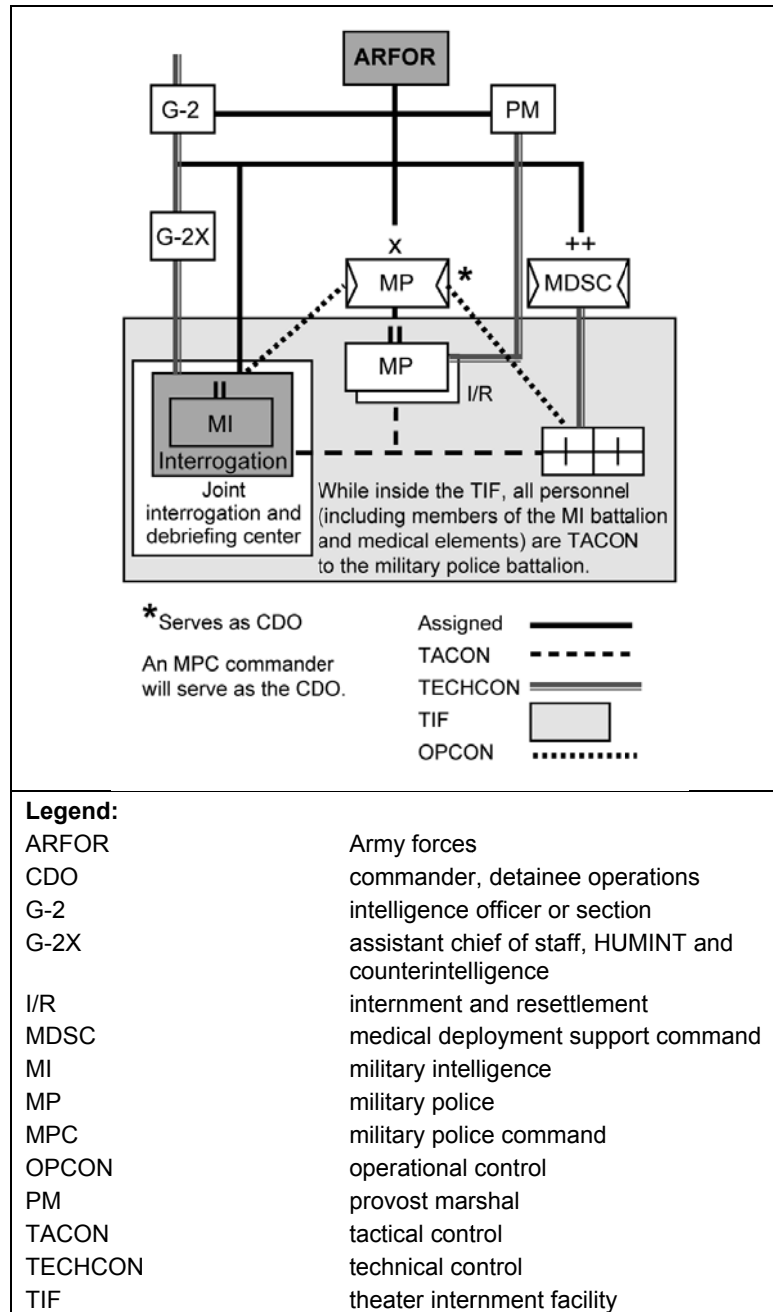

Figure 6-8. Sample TIF C2 in the theater with an MPC and multiple TIF

6-64. Choosing locations for TIFs is critical during the planning phase. The location of each facility will affect its ability to receive supplies. Receiving supplies through all supply classes is a top command priority. Failure to consider resupply procedures could result in an extended period of time in which detainees are without the rights and privileges required under U.S. policies and international laws.

PLANNING CONSIDERATIONS

6-65. Planning for operations at the TIF is a much greater challenge than at lower echelons. Planning the amount of support, ranging from medical to engineer, is time-consuming and critical to ensuring successful detainee operations. Proper planning before operations commence is vital. The planning should focus

across the DOTMLPF domain to ensure that all requirements are met. Synchronization with adjacent staff elements and commands is another important element.

6-66. At a minimum, training for operations at a TIF should include the following:

- Introduction to detainee operations.
- Detainee Reporting System training.
- Communications with detainees (cultural awareness).
- Introduction to the Geneva Conventions and U.S. policies on the humane treatment of detainees and DCs.
- Familiarization with stress management procedures.
- Introduction to HIV and universal precautions to take with HIV positive detainees.
- Advanced use-of-force criteria for I/R and interrogation operations.
- Introduction to frisk, cell, and area search procedures.
- Application of restraints.
- Personal safety awareness.
- Defensive tactics (unarmed self-defense).
- NLWs.
- Forced cell move procedures.
- Response procedures for a bomb and/or bomb threat.
- Current training support packages.
- Emergency response to fires, escapes, and disorders.
- Cell block operations.
- Meal procedures.
- Introduction to accountability procedures.
- Security and control activities.
- Familiarization with the special compound operations.
- Introduction to main gate/sally port operations.
- Written reports required to operate a TIF.
- Visitation operations.

RECEIVING AND PROCESSING DETAINEES

6-67. Interpreters may be requested from MI personnel, PSYOP personnel, multinational forces, or local authorities. This may also require identifying and clearing trusted detainees or local nationals to act as interpreters. Interpreters are absolutely necessary when entering required data into the Detainee Reporting System.

Receiving Detainees

6-68. When detainees are delivered to the TIF, they are segregated from those who arrived earlier and those who are partially processed. Military police ensure that—

- Detainees are counted and matched against the manifest. Military police must also ensure that they have documentation for the detainees, their personal property, and anything of evidentiary value.
- Detainees are field-processed if the capturing unit or the DCP did not previously process them. Military police should not release the escorting unit until proper documentation is completed.
- Detainees have a completed DD Form 2745 when they arrive, which will be used at the internment facility until they are issued ISNs.
- ISNs and the last names of the detainees are recorded on identification bands created by the Detainee Reporting System.

- Identification bands are attached to the left wrist of each detainee using the personnel identification banding kit (National Stock Number 8465-01-015-3245).
- Detainees' personal property and items of evidentiary value are stored in a temporary storage area until they are fully processed.
- Detainees are given DA Forms 4137 for any property temporarily or permanently stored in the internment facility storage area.
- Access to the temporary storage area is controlled.
- Detainees are provided food and water.
- Detainees are provided access to sanitation facilities.
- Detainees are provided first aid or medical treatment as required.
- Detainees are held in the receiving area until they can be processed.

6-69. Body cavity searches may be conducted for valid medical reasons or when there is reasonable belief that a security risk is present. Body cavity searches are not to be routine, are only conducted by authorized persons (trained medical personnel) according to DOD policy, and are subject to the following conditions:

- Performance of routine detainee body cavity exams or searches is strictly prohibited except for—
 - Valid medical reasons with the verbal consent of the individual.
 - When there is a reasonable belief that the detainee is concealing an item that presents a security risk.
- Examinations or searches are conducted by personnel of the same gender as the detainee if possible.
- Examinations and searches will be conducted in a manner that respects the individual.

Note. Body cavity searches other than those performed for valid medical reasons require the approval of the first general/flag officer in the chain of command.

6-70. Table 6-1, page 6-22, shows the nine stations that each detainee must go through to complete the processing, the responsible individuals at each station, and actions that must be accomplished. Based on mission variables and the commander's decision, the stations may need to be tailored to meet the situation. The procedures for receiving detainees are performed at stations 1 through 4, and the procedures for processing detainees are performed at stations 5 through 9.

6-71. When detainees arrive at the TIF, they will go through an initial screening within the sally port or holding area before a more comprehensive screening by MI personnel. This process provides HUMINT collectors with detainee information to be used when conducting interrogation operations. Subsequently, the detainees proceed through a templated processing and screening area that includes areas found in table 6-1, page 6-22.

Table 6-1. Nine-station internment process

Station	Purpose	Responsible Individual(s) ¹	Actions
1	Search	Military police	<ul style="list-style-type: none"> Assign each detainee an ISN to replace the DD Form 2745 number. Ensure that accountability procedures are followed. Sign DD Form 2708, and take custody of detainees (may use a manifest for this), their records, and their impounded property/evidence. Receive impounded property separately according to the Joint Travel Regulations and Joint Federal Travel Regulations. Conduct joint inventory with the transporting unit. Escort detainees, their property, and accompanying evidence. Strip-search detainees (use military police of the same gender) before entering the processing area unless conditions prohibit it. Remove and examine property/evidence, place it in a container or tray, mark it with the detainee's ISN, and take it to the temporary property storage area (where it is held until the detainee is processed). Prepare a receipt for the detainee's retained property/evidence using DA Form 4137 or field-expedient materials. Supervise detainee movement to the next station.
2	Personal hygiene	Military police and processed detainees (when possible)	<ul style="list-style-type: none"> Allow detainees to shower, shave, and get haircuts. Disinfect detainees, using the guidelines established by the PVNTMED officer. Allow detainees access to sanitation facilities. Supervise detainee movement to the next station.
3	Medical evaluation	Medical personnel and military police	<ul style="list-style-type: none"> Inspect detainees for signs of illness or injury to discover health problems or communicable diseases that may require medical evacuation. Provide medical and dental care according to AR 190-8. Decide which detainees need to be medically evacuated for treatment and to what facility. Evaluate detainees as prescribed by theater policy. Immunize or reimmunize detainees as prescribed by theater policy. Initiate treatment and immunization records. Place detainees' ISNs on their medical records to reduce the need for linguist support. Ensure that detainees' names, service numbers (if applicable), and ISNs were entered at Station 1 with the aid of an interpreter. Annotate in the detainee's medical records the date and place that the detainee was inspected, immunized, and disinfected. Document preexisting conditions and wounds in the detainees' medical records. Use photographs if appropriate. Obtain height and weight of detainees and annotate them in the DRS and on DA Forms 2664-R. Supervise detainee movement to the next station.
4	Personal items ²	Military police	<ul style="list-style-type: none"> Issue personal comfort items (toilet paper, soap, toothbrush, and toothpaste). Issue clothing from one of the following sources: <ul style="list-style-type: none"> The detainee's original clothing. Captured enemy supplies. Normal supply channels. Supervise detainee movement to the next station.

Table 6-1. Nine-station internment process (continued)

Station	Purpose	Responsible Individual(s) ¹	Actions
5	Administrative accountability	Processing clerk (assisted by an interpreter, MI personnel, or others) and military police	<ul style="list-style-type: none"> • Ensure that an ISN was assigned to each detainee using the DRS at Station 1. Annotate the ISN on DD Form 2745 so that late-arriving property can be matched to its owner. • Initiate personnel records, identification documents, DA Form 4137, and DA Form 4237-R. • Use the DRS and/or digital equipment to generate forms and records. • Prepare forms and records to maintain accountability of detainees and their property. (See AJP-2.5.) • Prepare forms for the repatriation or international transfer of detainees as specified in local regulations or SOPs. • Supervise detainee movement to the next station.
6	Biometrics collection (photographs, DNA data, fingerprints, and iris scans)	Military police	<ul style="list-style-type: none"> • Fingerprint detainees using a DOD electronic biometric collection set by recording the information required. • Prepare five-aspect photographs of each detainee using a digital camera. • Take photographs of the head, with the detainee looking forward, 45 degrees to the left and right and 90 degrees to the left and right. • Digitally upload photographs into the DRS. • Collect a DNA sample from each detainee using buccal (inside the cheek) swabs. • Create an identification band using the DRS. • Supervise detainee movement to the next station.
7	Property/evidence inventory ³	Military police	<ul style="list-style-type: none"> • Inventory and record, in the presence of the detainee, property brought from the temporary property storage area. • Complete a separate DA Form 4137 for returned, stored, impounded, and confiscated property. • List the property to be returned to the detainee or stored during internment on DA Form 4137. • Give the detainee a completed copy of DA Form 4137 for property placed in temporary storage. • Give the detainee a completed copy of DA Form 4137 as a receipt for money placed in the detainee's account. (See AR 190-8 and DFAS-IN 37-1.) • Return retained property that was taken from the detainee at Station 1. • Supervise detainee movement to the next station.
8	Records review	Military police	<ul style="list-style-type: none"> • Review the processed records for completeness and accuracy. • Escort detainees back to the appropriate stations to correct errors if necessary. • Allow detainees to prepare DA Form 2665-R (<i>Capture Card for Prisoner of War</i>). If they are being interned at the same place where they were processed, allow them to prepare DA Form 2666-R (<i>Prisoner of War Notification of Address/Prisoner of War Mail</i>). • Have another individual (someone that is authorized by the commander) complete DA Form 2665-R and/or DA Form 2666-R for detainees who are unable to write. • Supervise detainee movement to the next station. • Ensure that CIs have an order of internment, with a record of any appeal requested. Prepare an order of internment according to AR 190-8 if one has not been completed, including appeal rights.
9	Movement to living area	Military police	<ul style="list-style-type: none"> • Brief detainees on internment facility rules and regulations. • Escort detainees to their new living areas.

Table 6-1. Nine-station internment process (continued)

Notes.	
¹ The number of people who perform tasks depends on the number of detainees and the time available.	
² Detainees being categorized as CIs, RP, and enemy combatants are clothed according to AR 190-8.	
³ Property records must be maintained electronically using the DRS and on the original hard copy of DA Form 4137.	
Legend:	
AJP	allied joint publication
AR	Army regulation
CI	civilian internee
DA	Department of the Army
DD	Department of Defense
DFAS-IN	Defense Finance and Accounting Service-Indiana
DNA	deoxyribonucleic acid
DOD	Department of Defense
DRS	Detainee Reporting System
ISN	internment serial number
PVNTMED	preventive medicine
RP	retained personnel
SOP	standing operating procedure

Initial Processing

6-72. Initial processing is the gathering of critical information from detainees. The minimum information needed in the initial processing is—

- Complete name (first and last).
- Service number (only if classified as an EPW).
- DD Form 2745 number.
- Grade (only if classified as an EPW).
- Theater of capture.
- Power served.
- Detainee category.
- Capturing unit.
- Date of capture.
- POC (grid coordinates).
- Circumstances of capture.

6-73. The information collected during the initial inprocessing is entered into the Detainee Reporting System. Subsequently; an ISN is then issued to the detainee.

6-74. This information, along with the information needed to assign an ISN (capturing power, theater code, power served, sequence number, and detainee classification), is enough to move the detainee into the internment facility where additional data can be gathered as time permits. Much of the information comes directly from the DD Form 2745. The TDRC provides blocks of ISNs to make initial processing quick and effective.

Full Processing

6-75. Detainees are considered fully processed when all fields in the Detainee Reporting System are completed (this also includes fields from initial processing). Remember that detainees are only required to give their name, grade, and service number. Items such as the city of birth and next of kin are to be collected when possible; however, detainees are not required to provide this information.

6-76. AR 190-8 states that the NDRC is responsible for maintaining the following information and items on detainees:

- Date of birth.
- City of birth.

- Country of birth.
- Nationality.
- General statement of health.
- Power served.
- Name and address of a person to be notified of the detainee's capture.
- Address to which correspondence may be sent.
- Notification of capture and the date sent.

INTERMENT FACILITY ASSIGNMENT

6-77. The initial classification of a detainee is accomplished during processing and is based on the statements or identity papers that the detainee provides. Assignment to a specific compound within the internment facility is further based on the assumption that the identity the detainee provided was correct. This provides the basis for assignment to various compounds and the establishment of individual detainee personnel files.

CLASSIFICATION AND REASSIGNMENT

6-78. Once the detainee is assigned to a facility, expect a continuing need for further reclassification and reassignment. It may become necessary to reclassify the detainee a second time as the detainee's identity becomes apparent. Agitators, other detainees, or detainee leaders will eventually be uncovered by their activities. They may then be reclassified according to their new identity or ideology and reassigned to a more appropriate facility. Commanders at detention/internment facilities must conduct Article 5 or civilian internee review tribunals according to the procedures in appendix D.

Note. Article 5 tribunals are conducted if there is a doubt as to EPW status or upon the detainee's request. CIs (including suspected members of armed groups) should receive an order of internment, along with rights of appeal to a review board, within 72 hours of capture/internment if possible.

6-79. The reclassification and reassignment of detainees within a facility should be anticipated. The initial classification may be challenged by the detainees, MI personnel, or military police assets. For example, a detainee may come forward with statements or documentation that indicates that he or she should be reclassified, or military police and/or MI personnel may determine after observation that a detainee was incorrectly classified.

ADMINISTRATIVE PROCESSING AND RECORDS MANAGEMENT

6-80. From the POC until a detainee arrives at a TIF, the proper accountability, processing, and management of the detainee's record is crucial. Failure to do so indicates a breakdown in the chain of custody of a detainee. Moreover, it provides a perception to the media and others interested in detainee operations (for example, the protecting power) that care, concern, and overall detainee safety and well-being are not a prime concern to the guard force or elements conducting detainee operations. The overall protection of the guard force, commanders, MI personnel, and medical personnel (all of whom operate inside a TIF) is increased when the proper administrative recordkeeping is strictly enforced at the facility.

Records Management

6-81. All documentation related to the detainee's capture and any documents generated from the POC until the detainee is released will be maintained in the detainee's personnel file. If a detainee is transferred, the original file (containing medical, disciplinary, and administrative actions) will be provided to the receiving authority. If a detainee is released from DOD control, the original record will be sent to the TDRC.

6-82. Legal files generated for the purpose of HN prosecution will be maintained by the assigned/attached TIF SJA. Records management regarding future prosecution will include property captured at the POC

(annotated on DA Form 4137), written statements placing detainees at the scene where an offense/crime was committed (DA Form 2823), and any disciplinary statements obtained on those particular detainees throughout their detention.

Initiating Detainee Personnel Files

6-83. The I/R battalion must develop and maintain hard copies of personnel files on each detainee within the detainee facility. At a minimum, initiate detainee personnel files with the following forms:

- **DA Form 2662-R (EPW Identity Card)**. Completed if detainees do not hold an identification card from their country.
- **DA Form 2663-R (Fingerprint Card)**. Completed for detainees upon inprocessing into the facility.
- **DA Form 2664-R**. Initiated upon inprocessing detainees and updated monthly.
- **DA Form 4137**. Used to record currency and property confiscated from detainees.
- **DA Form 4237-R**. Completed on detainees upon inprocessing into the facility.
- **DD Form 2708**. Used to account for evacuated detainees, regardless of the evacuation channel.
- **DD Form 2745**. Used to tag detainees who are captured. (Detainees should arrive at the site with this form attached.)
- **DA Form 2823**. Used to record capture information.

Records and Reports

6-84. The commander may establish local records and reports that are necessary for the effective operation of the facility. These reports provide the commander with information concerning the control, supervision, and disposition of personnel housed in the facility. The commander determines the type of reports (administrative, operational, sustainment, and intelligence) and the frequency (routine or as required). Normal command and staff records and reports (such as DA Form 1594), worksheets, and situation maps are also required. (See appendix G.)

6-85. Additional records and reports that are generated at the TIF may include—

- DA Form 2674-R.
- DA Form 2823.
- DD Form 2064.
- DD Form 2713 (*Inmate Observation Report*) (available on the Detainee Reporting System).
- DD Form 2714 (*Inmate Disciplinary Report*).
- DD Form 503 (*Medical Examiner's Report*).
- DD Form 509 (*Inspection Record of Prisoner in Segregation*).
- DD Form 510 (*Request for Interview*).
- Memorandums for record (include incentives, incidents, or other situations not covered by other reports or records).
- Release or transfer orders available in the Detainee Reporting System.

Disciplinary Record

6-86. Each commander is required to maintain a record of disciplinary punishment administered to detainees. The use of DA Form 3997 (*Military Police Desk Blotter*) is suggested. Maintain this form at the facility at all times, even when detainees are transferred or released.

OPERATIONS

6-87. There are many varied components of TIF operations. These may range from identifying the proper linguists for employment to managing general security concerns within the facility. The paragraphs below are not all-encompassing, but merely provide considerations commanders must make when developing and implementing operations at the TIF level. Commanders must keep in mind that the primary focus of

internment facilities is detainees. Detainees should be respected and protected according to the Geneva Conventions.

Assigned Personnel

6-88. Personnel assigned or attached to the facilities should be specially trained in the care and control of housed personnel. Each individual should be fully cognizant of the provisions of the Geneva Conventions and the applicable regulations as they apply to the treatment of detainees. A training program does not occur once a deployment occurs. A proper training program begins during the mission-essential task list development and with early training and frequent reinforcement of collective and individual tasks that support the mission-essential task list tasks.

6-89. The necessary care and control of detainees is best achieved with carefully selected and trained personnel. The specialized nature of duty at the different facilities requires personnel who can be depended on to cope successfully with behavior or incidents that call for calm, fair, and immediate decisive action. These personnel must possess the highest qualities of leadership and judgment. They are required to observe rigid self-discipline and maintain a professional attitude at all times.

Multifunctional Boards

6-90. Establish multifunctional boards (according to AR 190-8) to assist the detention facility commander in the decisionmaking process. The detention facility commander, in coordination with the MI commander, will normally chair boards. Multifunctional boards provide full staff and stakeholder representation to ensure a comprehensive review, analysis, and assessment of current functions. Boards will normally consist of representatives from all interested stakeholders but, at a minimum, should include military police, MI, legal, and medical representatives. Representatives may also include HN civil authorities, other government agencies, military criminal investigative organizations, and contractors as appropriate. Boards should incorporate a formal process based on published protocols, to include publishing minutes, reporting findings, making recommendations to higher headquarters, adjusting current action plans, and scheduling follow-up meetings as necessary. Multifunctional boards should convene to address a variety of detainee-related functions, to include the following:

- Changes in a detainee's status (by Article 5 and CI review tribunals).
- Changes in detainee policy and detainee interrogation policy.
- Changes in release, transfer of custody, and repatriation procedures.
- Receipt of detainee complaints, allegations of abuse, and investigations.
- Corrective actions based on facility and operational assessments and inspections.
- Risk assessment, mitigation, and safety programs/plans.
- Review of detainee disciplinary policies and adjudication processes.
- Changes in detainee management/environment (compliance measures, integration of new facilities).
- Changes in ROE/RUF.
- Integration of approved new technologies and NLWs. (When dealing with detainees, the detention facility commander should thoroughly review appropriate use, assess risks, and provide new equipment training.)
- Establishment of ICRC or protecting power communications (does not preclude mandatory ICRC reporting according to DOD policy).
- Monitoring and implementing of detainee facility transition plans.

Standing Orders

6-91. Standing orders at a facility are used to provide uniform and orderly administration of the facility. Procedures, rules, and instructions to be obeyed by detainees must be published (in their language), posted where detainees can read and refer to them, and made available to those without access to posted copies. Detention facility commanders should ensure that standing orders are read to illiterate detainees in their

native language. These orders should generally include rules and procedures governing the following activities and other matters as appropriate:

- Schedule of calls. It may include, but is not limited to—
 - Reveille.
 - Morning roll call.
 - Readiness of quarters for inspection.
 - Sick call.
 - Mess call.
 - Evening roll call.
 - Lights out.
- Announcements of hours for religious services, recreational activities, and other activities.
- Emergency sick call procedures.
- Inspection procedures.
- Field sanitation and personal hygiene standards and procedures.
- Designated smoking areas.
- Laundry procedures and operations.
- Food service and maintenance operations and procedures.

6-92. Examples of standing orders for detainees may include the following:

- Comply with rules, regulations, and orders. They are necessary for safety, good order, and discipline.
- Immediately obey all orders from U.S. military personnel. Deliberate disobedience, resistance, or conduct of a mutinous or riotous nature will be dealt with by force.
- Noncompliance or any act of disorder or neglect that is prejudicial to good order or discipline will result in disciplinary or judicial punishment.
- Do not establish courts or administer punishment over other detainees.
- Do not possess knives, sticks, pieces of metal, or other articles that can be used as a weapon.
- Do not drill or march in military formation for any purpose except as authorized and directed by the detention facility commander.

EMERGENCY ACTION PLANS

6-93. TIF personnel will establish emergency action plans to assist in operating the facility. These plans may consist of—

- Fire drills.
- Air raid and indirect-fire drills.
- Disturbances (major/minor), including hostage situations.
- Emergency evacuations.
- Natural disaster drills, including severe weather.
- Blackouts.
- Escapes.
- Mass casualty situations.
- Defense against ground assault and response to a perimeter attack.

RULES OF INTERACTION

6-94. The ROI provide Soldiers with a guide for interacting with detainees. The following and other directives may be included in the ROI:

- Speak to detainees only when giving orders or in the line of duty.
- Treat all detainees equally and with respect as human beings.
- Respect religious articles and/or materials.

- Treat all medical problems seriously.
- Do not discuss politics or the conflict with detainees.
- Do not make promises.
- Do not make obscene gestures.
- Do not make derogatory remarks or political comments about detainees and their causes.
- Do not engage in commerce with detainees.
- Do not give gifts to detainees or accept gifts from them.

CONTROL AND DISCIPLINE

6-95. Military police maintain positive control of detainees under their care. The clear and consistent standards of behavior identified by the guard force will assist in maintaining discipline within the detainee population. Embedded within those standards is the inherent right to self-defense if a situation should arise. Through fair and humane treatment, military police can ensure that compliant detainee conditions are established.

6-96. Maintain humane but firm control by—

- Observing rigorous self-discipline.
- Maintaining a professional but impersonal attitude.
- Coping calmly with hostile or unruly behavior or incidents.
- Taking judicious, immediate, decisive action.

6-97. Military police take positive action to establish daily or periodic routines and responses that are conducive to good order, discipline, and control. They—

- Require compliance with policies and procedures that provide firm control of detainees.
- Use techniques that provide firm control of detainees.
- Give reasonable orders in a commanding voice, and strive to learn basic commands in the detainees' language to help them comply with facility standards and rules.
- Post copies of the Geneva Conventions (printed in the detainees' language) in the compound where detainees can read them.
- Post rules, regulations, instructions, notices, orders, and other announcements that detainees are expected to obey in areas where they can read them. Posted information must be printed in a language that they understand, and copies must be provided to detainees who do not have access to posted copies.
- Ensure that detainees obey rules, orders, and directives.
- Report a detainee's refusal or failure to obey an order or regulation.

6-98. The detention facility commander establishes the rules needed to maintain discipline and security in each facility. They are rigidly enforced. The following are never permitted:

- Fraternizing among detainees and U.S. armed forces or civilian personnel.
- Establishing relationships between detainees and U.S. armed forces or civilian personnel.
- Photographing or videotaping detainees for other than official reasons.
- Allowing detainees to establish their own court system.
- Donating or receiving gifts or any commercial activity between persons in U.S. custody and the U.S. armed forces.

6-99. If necessary, the military police commander or appointed officer can initiate general court-martial proceedings against detainees using the MCM; UCMJ; and U.S. laws, regulations, and orders in force during the time of their internment. The I/R battalion requires adequate MOS 27D personnel to accomplish this mission. Do not deliver detainees to civil authorities for an offense unless a member of the U.S. armed forces would be delivered for committing a similar offense. (See AR 190-8 for a complete discussion on detainee judicial proceedings.)

6-100. Only the internment facility commander or an appointed designee(s) may order disciplinary punishment without prejudice to the competence of the courts or higher authority. Detainees are not disciplined until they are given precise information regarding the offense(s) that they are accused of committing. The accused must be given a chance to explain their conduct and to defend themselves. The accused is permitted to call witnesses and use an interpreter if necessary. Disciplinary measures, the duration of which will not exceed 30 days, include—

- The discontinuation of privileges that are granted over and above those provided for by the Geneva Conventions.
- Segregation.
- A fine, not to exceed one-half of the advance pay and working pay that the detainee would otherwise receive during a period of not more than 30 days.
- Fatigue duties (extra duty), not to exceed 2 hours per day. This duty will not be applied to officers. NCOs can only be required to do supervisory work.

INFORMATION COLLECTION

6-101. Information collection methods relative to detainee activities may include—

- Conducting periodic and unannounced compound searches and patrols.
- Searching individual detainees on departure from and return to the internment facility.
- Training all personnel in the techniques of observing, recognizing, and reporting information that may be of intelligence value, such as—
 - Unusual activities, especially before holidays or celebrations.
 - Messages being passed between groups of detainees and CIs on labor details.
 - Messages being passed to or from local civilians while detainees are on labor details.
 - Messages being signaled from one compound to another.
 - Detainees volunteering information of potential intelligence value.
- Ensuring that actions are taken to protect detainees from reprisal by removing or transferring them to safe facilities once they provide information.

COMPOUND OPERATIONS

6-102. For efficient compound operations, implement the following:

- **Accountability procedures.** These procedures are used to track the location and population of detainees. Such measures may include scheduled and random head counts.
- **Observation and disciplinary reports.** These reports are used to document infractions of facility rules.
- **Juvenile segregation rules.** These rules are used to protect juveniles from the adult population.
- **Special housing unit/segregation procedures.** These procedures are used for the detainee's protection and for disciplinary, medical, or administrative reasons.
- **Personal property procedures.** These procedures are used to ensure that detainees properly account for and store personal property.

HEALTH AND COMFORT ITEMS

6-103. Meeting the subsistence needs of detainees is one of many measures implemented to ensure that humane treatment is provided to them. Subsistence needs may include—

- **Clothing.** Proper clothing should be issued to detainees to protect them from the elements. The use of personal clothing is encouraged when standard facility issue is not available.
- **Bedding.** Bedding should be provided to detainees according to AR 190-8 and established SOPs.

- **Personal-hygiene items.** Personal hygiene items and activities should be provided to detainees on a daily basis as available. Such provisions ensure a healthy environment for facility personnel, including the security force.
- **Food.** The daily individual food ration for detainees will be sufficient in quantity, quality, and variety to keep them in good health and prevent nutritional deficiency. The TIF command may require a dietician to properly determine caloric intake for detainees.

EMERGENCY PROCEDURES

6-104. The implementation of emergency procedures is important to ensure the safety and security of TIF personnel and detainees. These procedures, developed and implemented by the TIF command, may include—

- Risk assessments and risk mitigation measures.
- Training and certification.
- Rehearsals and adjustments to SOPs based on lessons learned and observations of effective practices.
- After-action reviews.
- Training of newly arrived personnel on emergency procedures.

INTEGRATION OF EMERGING TECHNOLOGY

6-105. Commanders and staff may be prone to take off-the-shelf technology and incorporate it into TIF operations. However, subsequent to higher headquarters approval, proper planning, risk assessments/mitigation, training, certification, and indoctrination must be considered before implementing such technologies into day-to-day operations at the TIF.

INCIDENT REPORTING

6-106. All reportable incidents—any suspected or alleged violation of DOD policy, procedures, or applicable laws for which there is credible information—that DOD personnel or contractors allegedly commit will be—

- Promptly reported and investigated by proper authorities.
- Remedied by disciplinary or administrative action when appropriate. On-scene commanders and supervisors ensure that measures are taken to preserve evidence pertaining to any reportable incident.

SECURITY CONSIDERATIONS

6-107. The military police commander should use security measures that effectively control detainees with the minimum use of force. The same use of force that is employed for one category of detainees may not be applicable to another. Security measures must protect housed personnel from threats outside the facility. Maintaining a high state of discipline, a system of routines, and required standards of behavior are all measures that enhance effective internal security and control. Security and control activities at a TIF include—

- Accountability procedures.
- Guard force duties.
- Main gate/sally port procedures.
- Tower guard duties.
- Perimeter (mobile/foot) security.
- Reaction-force duties.
- Close-contact guard duties.
- Key control.
- Contraband control.

- Detainee correspondence control.
- Escort procedures.
- Restraint procedures.
- Segregation.
- Forced cell move procedures.

6-108. Control and accountability of detainees must be maintained at all times. Policies, tactics, techniques, and procedures must be adapted to achieve this end state.

6-109. Expect some detainees to actively cooperate with U.S. armed forces authority or assume a passive and compliant role. Cooperative or compliant personnel may be composed, in part, of individuals with ideologies favorable to the United States. Others, through resignation or apathy, will simply adapt to the conditions of their internment.

6-110. Some detainees will engage in activities to embarrass and harass U.S. armed forces at every opportunity. In the case of enemy combatants, this is to force the facility to use the maximum number of troops to keep them away from combat missions. In addition, these activities, regardless of the type of detainees participating, will create valuable propaganda for their cause. The leaders of this uncooperative faction may attempt to ensure a united effort and blind obedience by all members. They will not be content with merely planning and attempting to escape or using normal harassment tactics. The leaders will assign duties and missions to individuals so that resistance will not stop while they are interned. Detainees will immediately detect and fully exploit any relaxation of security.

6-111. The commander should use security measures that effectively control detainees with a minimum use of force. Adverse actions by detainees will vary from acts of harassment to acts of violence. Detainees may—

- Refuse to eat.
- Refuse to attend formations, refuse to work, or work in an unsatisfactory manner.
- Malingering.
- Sabotage equipment and facilities.
- Assault other detainees or guard personnel.
- Take hostages to secure concessions.
- Attempt individual escapes or mass breakouts.
- Intimidate other detainees.
- Fabricate weapons or other illegal items.
- Print and circulate propaganda material.
- Create embarrassing situations or make false accusations to influence international inspection teams or members of the protecting powers and the ICRC.
- Instigate disturbances or riots to place the detention facility commander and staff in an unfavorable position to gain concessions and influence custodial policies.

Intrusion Detection System

6-112. The detention facility commander should consider the use of intrusion detection systems (motion and detection sensors) for the early detection of detainees attempting to escape from the facility. Such systems may also be applied to external threats along the perimeter security of the facility. Additionally, ground-penetrating radar should be considered for the detection of underground tunnels as part of a material solution within a facility.

Security Precautions

6-113. The following are common places where detainees from different compounds and internment facilities may use to communicate with each other:

- **Internment facility dispensary and food distribution points.** Messages may be hidden where other detainees from neighboring compounds can find them. Alert observations and periodic searches will minimize the value of these areas.
- **Infirmary facility.** If a detainee is sick or injured, a careful examination should be done to ensure that hospitalization is required. Patients should not be informed of their discharge until the last possible moment. A complete search of detainees and their personal effects is completed upon admission and discharge from the hospital.
- **Work details.** Guards should maintain an adequate distance between details to preclude the exchange of information between detainees.

Work Detail Security Requirements

6-114. Work details must have sufficient guards to ensure security and prevent escape. Guards must keep a reasonable distance from the work detail and properly position themselves to provide the best observation of the area and work detail. Authorized rest breaks by the guards should be taken separately and while detainees are working.

Military Working Dogs

6-115. MWDs are trained for scouting, patrolling, and performing building and area searches. Properly trained MWDs can prevent a detainee from escaping. Some MWDs have also been trained to track, although this is not a required skill for all MWDs. The local MWD kennel master will know which dogs have been trained to track.

WARNING

MWDs will not be used during any interrogation process.

Escape Prevention and Early Detection

6-116. Detainee escapes can be kept to a minimum through proper security precautions. These precautions include—

- Conducting periodic, unannounced, and systematic searches of internment facility areas to detect evidence of tunneling and to discover caches of food, clothing, weapons, maps, money, or other valuables.
- Maintaining strict accountability for tools and equipment used by or accessible to detainees.
- Inspecting perimeter fencing daily to detect cut wire evidence or other weaknesses in the fence.
- Assessing lighting systems during hours of darkness to detect poorly lit areas along the perimeter. Immediately replace any burned out or broken light bulbs.
- Conducting training, to include refresher training, to ensure that guard and security personnel are thoroughly familiar with security precautions, techniques, and procedures.
- Searching vehicles and containers taken into or out of the internment facility.
- Closely supervising the disposition of unconsumed rations in the internment facility and on work details to prevent the caching of food supplies.

6-117. The following measures will assist in the early detection of escape attempts:

- Conduct ISN counts and head counts on a regular and an unannounced basis.
- Conduct roll calls at least twice daily, preferably early in the morning and again before “lights out.”
- Conduct other head counts independent of roll calls. Appropriate times for additional detainee head counts might be immediately following a mass disturbance, the discovery of an open tunnel, or the detection of a hole or break in the fence.

- Conduct head counts at frequent intervals while on work details and en route to another internment facility.

SUICIDE RISK

6-118. Military police may initially determine that certain detainees need to be placed on suicide watch even before a behavioral assessment has been done.

6-119. If a TIF staff member determines that a detainee should be carefully observed to ensure his or her safety, the staff member places the detainee in an observation cell adjacent to the control point if available. Military police should search the detainee and remove all items that could be used in a suicide attempt (for example, bed sheets). If the detainee makes suicidal gestures with articles of clothing, remove everything from the cell except the detainee's underwear. Ensure that the detainee is continuously monitored while in the observation cell. Have a mental health team member evaluate the detainee before returning him/her to the general population. TIF security personnel will log each time a mental health team member evaluates a suicidal detainee.

6-120. If a TIF staff member has problems, concerns, or disagreements about suggestions for care of a detainee made by a mental health team member, the staff member will contact the TIF commander to discuss the matter. However, the military police will not simply disregard the recommendation of the mental health team member.

6-121. If a TIF staff member feels that a detainee can be safely removed from a suicide watch status, the staff member may make this recommendation to a supervisor. The supervisor will assess the recommendation and situation and, if deemed appropriate, may recommend to the mental health team member that the detainee be removed from suicide watch status. The mental health team member provides the recommendation to the psychiatrist or psychologist for resolution. Under no circumstances will TIF security personnel or other staff members remove a detainee from a suicide watch status without the permission of a psychiatrist or psychologist. No other mental health team member has the authority to remove a detainee from a suicide watch status. The psychiatrist or psychologist may interview the patient personally or discontinue the watch based on the recommendation of a mental health team member.

SUICIDE RESPONSE

6-122. If a detainee seems to be undergoing a severe emotional crisis and a suicide attempt seems imminent, notify a mental health team member. If a detainee appears suicidal and professional help has not arrived, personnel should—

- Call for backup.
- Approach the detainee calmly and with concern. Do not panic.
- Ask how they can help.
- Listen carefully without challenging. Avoid arguing with the detainee.
- Physically prevent the detainee from self-harm if necessary.

6-123. If military police or other TIF staff members come upon a detainee who has hung himself or herself—

- Immediately lift the detainee to relieve pressure on his or her neck, and support his or her head when doing so.
- Immediately call for backup and notify emergency medical treatment personnel and mental health team members.
- Cut the item by which the detainee is hanging. Cut it above or below the knot if possible, so that the knot can be preserved as evidence.
- Provide first aid as necessary.

6-124. If a detainee has made a suicide attempt by another method, procedures will depend on the specific suicide attempt. If the detainee—

- Has made a cutting attempt, try to control bleeding with direct pressure first. Call emergency medical treatment personnel to further evaluate the detainee and determine if evacuation to a medical treatment facility is required for treatment. After medical treatment has been rendered, observe the detainee in the observation cell until a mental health evaluation can be accomplished.
- Took an overdose of medication, immediately call emergency medical treatment personnel so that proper care can be rendered once the security force has been notified. Notify the mental health team that medical clearance has been granted.

Note. Immediately notify the mental health team regardless of the time of day, following any suicide attempt by a detainee.

HUMAN INTELLIGENCE SUPPORT

6-125. At the TIF, HUMINT collectors conduct interrogation operations from within the interrogation area. The JIDC or MI battalion is normally found within the boundaries of the TIF. When operating within the TIF, HUMINT collectors are tactical control to the I/R battalion commander for the humane treatment, evacuation, custody, and control (reception, processing, administration, internment, and safety) of detainees; protection measures; and the operation of the internment facility. For HUMINT support at the TIF, the JIDC commander is responsible for conducting interrogation operations (including the prioritization of effort), and controlling the technical aspects of interrogation and other intelligence operations. The intelligence staff maintains control over interrogation operations through technical channels to ensure adherence to applicable laws and policies, ensure the proper use of doctrinal approaches and techniques, and provide technical guidance for interrogation activities. Applicable laws and policies include U.S. laws, the law of war, relevant international laws, relevant directives (including DODD 3115.09 and DODD 2310.01E), DODIs, execution orders, and FRAGOs. The C-2X and/or J-2X provide technical direction and control to the JIDC. (See FM 2-22.3 for additional details on HUMINT operations in conjunction with detainee operations.)

6-126. The tactical control relationship is geared primarily toward ensuring proper protection and base defense and that the JIDC commander is responsible for conducting interrogation operations (including prioritization of effort) and controlling interrogation and other intelligence operations through technical channels.

Note. Under no circumstances will military police set the conditions for detainee interrogations. Military police only provide information based on passive observation of detainees. Passive information collection may include observing (during transport to a medical tent, during recreation time) detainees.

MEDICAL OPERATIONS

6-127. Medical support at a TIF address medical care and sanitation requirements. Medical care may include medical evaluations, routine treatment, detainee sick call, hunger strikes, preventive medicine, inspections, and associated medical documentation. Sanitation requirements include disease prevention and facility cleanliness, among others. (See appendix I.)

Medical and Dental Care

6-128. Commanders must consider the following when establishing medical care for the TIF (see AR 190-8):

- Examinations must be provided for detainees from a credentialed health care provider each month. The examiner records detainee weight on DA Form 2664-R. The Detainee Reporting System also requires weight data from the medical community.

- The general health of detainees, their nutrition, and their cleanliness are monitored during inspections.
- Detainees are examined for contagious diseases, especially tuberculosis, lice, louse-borne diseases, sexually transmitted diseases, and HIV.
- Medical treatment facilities must provide for immunization the isolation of detainees with communicable diseases.
- Retained medical personnel and detainees with medical training are used to the fullest extent possible when caring for sick and wounded detainees.
- Detainees requiring a higher level of care are transferred to military or civilian medical installations where the required treatment is available. The United States will not evacuate detainees out of country/theater for care that is not available in the theater.
- Military police escort detainees to medical facilities and remain with the until medical examinations are complete.

6-129. Patient services for detainees at a TIF should include the following, as a minimum:

- Daily sick call.
- Biweekly diabetic clinic.
- A dental clinic.
- Medication.
- Wound care.
- Physical therapy.
- 24-hour emergency room.
- Optometric services.
- Orthopedic services.
- Surgical facilities.
- Prosthesis clinic.
- Mental health clinic.
- Laboratory services.

Sanitation/Preventive Medicine

6-130. Detention facilities may serve as a breeding ground for pests and diseases. Sanitation standards must be met to prevent these conditions and ensure the cleanliness of the facility. Unit field sanitation teams, according to AR 40-5 and FM 4-25.12, are the first line of defense for ensuring that these standards are properly maintained. The standards are as follows:

- Provide adequate space within housing units to prevent overcrowding.
- Provide sufficient showers and latrines for detainees, and ensure that showers and latrines are cleaned and sanitized daily.
- Teach detainees working in the dining facility the rules of proper food sanitation, and ensure that they are observed and practiced.
- Properly dispose of human waste to protect the health of detainees and U.S. armed forces associated with the facility according to the guidelines established by preventive medicine.
- Provide sufficient potable water for drinking and food service purposes. At a minimum, detainees should receive the same amount of water that is afforded U.S. military personnel.
- Provide sufficient water for bathing and laundry.
- Provide necessary materials for detainee personal hygiene.
- Train U.S. military personnel on the proper disposition of dining facility and personally generated garbage so as not to breed insects and rodents that can contribute to health hazards.
- Institute measures against standing water within the facility.
- Conduct pest control activities as required.
- Conduct medical-, occupational-, and environmental-health surveillance.

STRATEGIC INTERNMENT FACILITY

6-131. A SIF is a facility, designated by the Secretary of Defense or a designee, with the capability to further detain and/or exploit detainees who hold strategic intelligence or who pose a continuing threat to the U.S. or U.S. interests. Detainees are normally noncompliant and may pose a high security risk to the United States. A SIF will usually resemble a TIF with respect to the operating procedures implemented and stated in the section above, but it is task-organized for a specific detainees.

LOCATION

6-132. The SIF is a long-term or semipermanent facility with the capability of holding detainees for an extended period of time. The location of SIF will be depends on the orders and directives published from the highest levels of the national government. A SIF is normally located outside a joint operations area where combat and/or stability operations are ongoing. SIFs fall under the C2 of combatant commanders.

ADDITIONAL PLANNING CONSIDERATIONS

6-133. A SIF will normally have a higher mix of forces involved as compared to operations at a TIF. For example, the Navy may completely run the hospital operations. Key organizational elements within a SIF may include—

- Joint security group.
- Joint interrogation group.
- Detainee hospital.
- Joint logistics group.
- Joint interrogation operations group.

6-134. Special staff considerations may include—

- Joint visitor's bureau.
- Chaplain.
- Inspector general.
- SJA.
- Public affairs support.
- Surgeon.
- Forensic psychologist.
- Forensic psychiatrist.
- Medical plans and operations officer.
- Environmental health officer.

6-135. Additional considerations at the SIF may also include—

- **Religion.** Detainees are allowed the freedom of worship, including attendance at services of their respective faith held within the internment facility. Detainees are not entitled to privileged communication with U.S. chaplains. However, commanders who do not wish to broach that privileged communications status should not place U.S. chaplains in situations where that privilege may be questioned. Retained chaplains and clergymen are permitted to devote their full time to ministering members of their faith within the internment facility. The military police commander may permit other ordained clergymen, theological students, or chaplains to conduct services within the compound. U.S. military personnel (such as guards and staff) will not attend services with detainees. However, guards should be present to ensure security and maintain custody and control of detainees.
- **Recreation.** For detainees, their active participation in recreational activities will, in addition to promoting general health and welfare, serve to alleviate the tensions and boredom of extended detention. In addition to athletic contests, group entertainment may be provided in the forms of concerts, plays, recorded music, and selected motion pictures.

- **Safety.** A safety program for detainees is set up and administered in each internment facility. ARs, circulars, and DA pamphlets are used as guides for establishing the safety program. Records and reports used to support the detainee safety program are maintained separately from those that support the Army Safety Program.
- **Agriculture.** Some detainees, depending on their category, may be allowed to raise vegetables for their own use. Subsequently, commanders must be aware of resources, procedures, and HN guidelines applicable to this program.

6-136. Article 5 tribunals and enemy combatant review boards are normally conducted at the SIF. These formal processes assist commanders and personnel in DOD with determining whether to release or detain a detainee.

HUMAN INTELLIGENCE SUPPORT

6-137. A joint interrogation group which may include uniformed DOD personnel and other government agencies that may be involved in the collection of intelligence, will normally be located at the SIF. The intelligence efforts at the SIF focus primarily on intelligence at the highest national security levels.

MEDICAL OPERATIONS

6-138. A detainee hospital with the capability to perform all levels of medical care is normally found at a SIF. The detainee hospital may also include personnel who can provide basic medical care to psychological and psychiatric experts.

SECURITY CONSIDERATIONS

6-139. Security measures will closely resemble those at a TIF, but may vary in certain aspects. These differences include—

- Higher security level.
- Enhanced access/entry control.
- Higher risk level.
- Geographic location.
- Inter-theater transportation considerations.
- Increased media attention.
- Interagency and international visitation policies.
- Strategic level of interrogations.

6-140. Due to operation security concerns, only make public notification of a release or transfer in consultation and coordination with the Office of the Secretary of Defense.

TRANSFERS OR RELEASES

6-141. Transfers or releases may be a result of reclassification or other situations requiring the movement of detainees. The transfer of detainees from one facility to another is conducted under conditions comparable to those for members of the U.S. armed forces when possible. Moreover, detainee release procedures are similar to transfer procedures from one facility to another. The only difference is coordination between HN assets and/or the protecting power (release to the ICRC). Security measures are determined by the military police and can be influenced by the type of detainee being transferred or released, the mode of transportation used, and other pertinent conditions. AR 190-8 prescribes the procedures governing detainee transfers and releases. All proposed transfers and releases should be reviewed by the legal advisor (at the Office of the Secretary of Defense level for SIF-related actions) to ensure compliance with applicable laws and policies. A detainee may not be released to a nation or force if it is known that the detainee will be subject to death, torture, or inhumane treatment based on the individual's detention by U.S. or multinational authorities. Due to operation security concerns, only make public notification of a release and/or transfer in consultation and coordination with the Office of the Secretary of Defense.

6-142. The facility commander who is transferring or releasing a detainee (see table 6-2) is responsible for—

- Publishing a transfer or release order using the Detainee Reporting System, informing detainees of their new postal addresses in time for them to notify their next of kin, and informing the TDRC or NDRC of the transfer.
- Notifying the gaining facility or HN of impending detainee transfers or releases.
- Verifying the accuracy and completeness of the personnel records of each detainee and providing the record, in a sealed envelope, to the military police accompanying the movement. The TIF commander must ensure that a copy of detainee medical and personnel records is maintained at the TIF when a transfer or release occurs.
- Verifying that detainees have authorized clothing and equipment in their possession.
- Segregating, out-briefing, performing a medical screening on, and administering conditional release statements for detainees being released.
- Preparing the detainee’s impounded personal property for shipment or return as appropriate.
- Briefing the escort military police Soldiers concerning their duties and responsibilities, to include procedures to be followed in case of an escape, death, or another emergency.
- Providing or arranging for rations, transportation, and transmission of appropriate notifications according to prescribed procedures.
- Preparing paperwork in English and the HN language (if required) before transferring or releasing detainees.

Table 6-2. Detainee transfer or release process from a TIF/SIF

<i>Procedure</i>	<i>Action</i>
Control and accountability procedures	<ul style="list-style-type: none"> ● Maintain control and accountability of detainees until transferred to a gaining facility or released to the designated protecting power. ● Conduct a medical exam of detainees within 24 hours of their transfer or release. ● Provide detainees with enough personal medication to last throughout the transfer or release. ● Use a transfer or release order to maintain accountability. It must contain, at a minimum, the following for each detainee: <ul style="list-style-type: none"> ▪ Name. ▪ Grade and/or status. ▪ ISN. ▪ Power served or nationality. ▪ Physical condition. ● Use a transfer or release order as an official receipt of transfer or release. It will become a permanent record to ensure that each detainee is accounted for until final transfer or release.
Detainee record procedures	<ul style="list-style-type: none"> ● Transfer copies of the detainee personnel, financial, and medical records. ● Transfer records to the custody of the designated official receiving the detainee. ● Transmit digital copies, if available, of the detainee’s record to the gaining location or HN/protecting power. ● Keep copies of all records.
Detainee personal property procedures	<ul style="list-style-type: none"> ● Transfer confiscated personal property that can be released to the gaining facility, gaining HN, or protecting power. ● Conduct an inventory and identify discrepancies. ● Have detainees sign DA Form 4137 for their personal items.

Table 6-2. Detainee transfer or release process from a TIF/SIF (continued)

<i>Procedure</i>	<i>Action</i>
Completion of transfer procedures	<ul style="list-style-type: none"> • Forward the manifest to the TDRC.
Transfer procedures	<ul style="list-style-type: none"> • Ensure that the transferring TIF forwards official records and confiscated property (which cannot be released) to the TDRC for final disposition once the TDRC notifies them that the transfer or release is complete.
Legend:	
DA	Department of the Army
HN	host nation
ISN	internment serial number
TIF	theater internment facility
TDRC	theater detainee reporting center

Note. Each detainee can ship personal property that does not exceed 55 pounds. Chaplains or detainees who have been serving as clergymen are permitted to transfer (at government expense) an additional 110 pounds to cover communion sets, theological books, and other religious material. If the detainee possesses personal property in excess of 55 pounds, have the detainee select which personal items are going to be transferred. (See AR 190-8.)

6-143. The temporary transfer of detainees is authorized when the detainee population is beyond the immediate capability of U.S. armed forces to manage. The CDO will develop measures to ensure that transferred detainees are accounted for and treated humanely. Detainees captured or detained by other branches of Service are turned over to the U.S. Army at receiving points designated by the joint force commander. All inter-Service transfers should be affected as soon as possible after initial classification and administrative processing have been accomplished.

6-144. Other informational requirements to consider when transferring or releasing detainees may include—

- The capability of the police and prison organizations to properly maintain structurally sound facilities and ensure the humane treatment of detainees.
- The status of organized crime within the area that may influence when and how detainees are released (for detainee and escorting unit safety).
- The status of the national legal systems and their ability to properly receive detainee paperwork and material properly.

CONSTRUCTION/MODERNIZATION OF PENAL FACILITIES

6-145. It is entirely possible over the course of operations for DHAs to evolve into long-term internment facilities and, ultimately, transform into civil authority penal institutions. Great care should be taken during planning stages to ensure that new construction is designed and built in such a way that internment facilities can be converted into acceptable penal institutions. Military police with I/R expertise assist planners with design requirements for long-term construction projects to ensure international acceptability and effective and efficient security designs. (See appendix J.)

TRAINING REQUIREMENTS, TRAINING STANDARDS, AND PROFESSIONAL DEVELOPMENT OF CIVIL AUTHORITIES

6-146. Military police with I/R expertise are an integral part of the assessment and subsequent development of training requirements necessary for preparing local nationals to perform civil penal system functions. Training support packages and programs of instruction used to train I/R units and in-lieu-of units

should be properly modified and refined to enable the trainers to conduct high-quality, standardized training for the conduct of penal operations.

This page intentionally left blank.

Chapter 7

Confinement of U.S. Military Prisoners

Aside from the normal and continuing mission for confinement of U.S. military prisoners at Fort Leavenworth and other permanent locations, there is a requirement to be prepared for confinement outside established facilities. In a mature theater, military police may be required to operate a field detention facility (FDF) and/or a field confinement facility (FCF) to hold or confine U.S. military prisoners for short terms. This short term may be as part of pretrial or posttrial confinement. Posttrial confinement may include temporary custody until the prisoner is evacuated from the theater to a permanent confinement facility or short-term sentences as determined by the combatant commander. Military police leaders tasked with conducting U.S. military prisoner operations must be familiar with the doctrine described in this chapter, the policies outlined in AR 190-47, and the tasks described in Soldier Training Publication (STP) 19-31E1-SM and STP 19-31E24-SM-TG. The U.S. Army Corrections Command, a field-operating agency of the PMG, is responsible for confinement/corrections policy development and operational implementation. Additional questions about confinement of U.S. military prisoners should be addressed to the U.S. Army Corrections Command. U.S. military prisoner operations are a subelement of I/R operations and may need to be performed across the spectrum of operations. Senior military police commanders are informed and prepared to provide retention and subsequent battlefield confinement of U.S. military prisoners. PMs at all echelons must be prepared to provide staff expertise to their respective commanders to ensure adequate and proper confinement of U.S. military prisoners. The same standards of humane treatment apply in this environment as in other areas of I/R operations.

Note. The rights of U.S. military prisoners are outlined in AR 190-47 and DODD 1325.4.

U.S. BATTLEFIELD CONFINEMENT OPERATIONS PRINCIPLES

7-1. The FCF/FDF is an integral part of the U.S. military justice system that commanders use to help maintain discipline, law, and order. The FCF/FDF provides a uniform system for incarcerating and providing correctional services for those who have failed to adhere to legally established rules of discipline. When conducting confinement operations for U.S. military prisoners, units—

- Foster a safe and secure environment while maintaining custody and control.
- Prepare prisoners for release, whether returning to duty or to a civilian status.
- Provide administrative services and limited counseling support.
- Ensure that prisoners are provided adequate access to the courts.
- Transfer U.S. military prisoners to Army Corrections System facilities as required.

PLANNING PROCESS FOR U.S. MILITARY PRISONERS

7-2. Military police plan U.S. military prisoner operations to meet the needs of the combatant commander. The commander may decide to establish U.S. military prisoner facilities within the theater if the—

- Projected or actual number of U.S. military prisoners exceeds the unit handling capability and has the potential of interfering with the pace of military operations.

- Distance from the theater to confinement facilities outside the continental United States (OCONUS)/CONUS is too great, making the evacuation of prisoners impractical.
- Necessary transportation assets are not available to evacuate U.S. military prisoners quickly to other confinement facilities.
- Length of military operations and the maturity of the theater enable the establishment of confinement facilities within the theater.
- Establishment of a confinement facility does not interfere with the commander's ability to meet other operational needs.

7-3. The PM assumes an important role in keeping the combatant commander informed throughout the planning of U.S. military prisoner operations. The PM coordinates closely with SJA, CA, HN authorities, appropriate echelon coordinating staff (such as the assistant chief of staff, personnel [G-1] and G-2), and major subordinate commands before recommending the establishment of U.S. military prisoner confinement facilities within the theater of operations. During the planning process, the PM determines—

- Availability of confinement facilities.
- Location of an FCF in the theater.
- Availability of resources and sustainment support needed to construct and operate the confinement facility.
- Availability of adequate and technically appropriate military police forces (I/R augmentation or selective task organization may be required).
- Classification and type of prisoner to be interned (pretrial, posttrial, and/or inter-Service).
- Requirements for prisoner evacuation.
- Requirements of supported forces.
- Requirements that may impact the overall U.S. military prisoner operation.

BATTLEFIELD FACILITIES

7-4. There are two types of battlefield facilities—FDF and FCF. When the combatant commander makes the decision to retain U.S. military prisoners in the theater, FDFs are possible as low as the BCT level, while an FCF is typically established at theater level and is responsible for longer-term confinement before the evacuation of U.S. military prisoner from theater. The evacuation of U.S. military prisoners from an FDF to an FCF, or from an FCF to a permanent facility, is completed according to established guidelines and available facilities.

FIELD DETENTION FACILITY

7-5. Military police use FDFs to detain prisoners placed in custody for a short term. FDFs are used to hold prisoners in custody only until they can be tried and sentenced to confinement and evacuated from the immediate area. When possible, prisoners awaiting trial remain in their units and not at an FDF. Only when the legal requirements of Rules for Court-Martial 305k. Prisoners will be placed in pretrial confinement and retained by military police. Rules for Court-Martial 305k requires probable cause belief that a court-martial offense has been committed, that the prisoner committed it, and that a more severe form of restraint is necessary to ensure that the prisoner will appear at pretrial proceedings or the trial or to prevent serious criminal misconduct. PMs are responsible for the location, setup, and operation of FDFs.

7-6. When operating an FDF, military police sign for each prisoner using DD Form 2707 (*Confinement Order*) and sign for each prisoner's property using DA Form 4137. Policies and procedures on the care and treatment of prisoners and the safeguarding of a prisoners' personal effects apply to FDFs and FCFs. If preexisting structures are available, use them as FDFs. If tents are used, they should not be smaller than the general purpose, medium tent. Probable equipment and supplies required for the establishment of an FDF include, but are not limited to—

- Barbed wire (roll and concertina).
- Fence posts.
- Gates and doors.

- Floodlights and spotlights.
- Generator(s).
- Food service and cleaning equipment.
- Water cans and/or lister bags.
- First aid equipment and supplies.
- Clothing and bedding.

FIELD CONFINEMENT FACILITY

7-7. Military police may be required to establish an FCF in the theater to detain prisoners placed in custody for a short term (pretrial, posttrial, or until transferred to another facility outside the theater). The prisoner is transferred from an FDF to the FCF using DD Form 2708. DD Form 2707 (on which the prisoner was signed for) and DA Form 4137 (on which the prisoner's property was signed for) also accompany the prisoner. The FCF may be a semipermanent or permanent facility that is better equipped and resourced than an FDF. The respective unit commander and staff use the military decisionmaking process to determine the specific tasks that must be performed to accomplish the mission. Some of these tasks include—

- Selecting a facility location and constructing the facility.
- Determining processing, classification, and identification requirements.
- Providing clothing and meals.
- Providing medical care and sanitation facilities.
- Exercising discipline, control, and administration.
- Conducting emergency planning and investigations.
- Enforcing ROI and RUF.
- Providing transportation.
- Overseeing the transfer and disposition of U.S. military prisoners.

7-8. The location of the FCF depends on several factors—sustainment assets (availability of transportation, medical facilities), terrain and preexisting structures, enemy situation, existing LOCs, battlefield layout, and mission variables. The PM must coordinate with engineers, SJA, HN authorities, and coordinating staff before a site is selected. The FCF should be located away from perimeter fences, public thoroughfares, gates, headquarters, troop areas, dense cover, and wooded areas.

7-9. The construction of the FCF depends on the availability of existing structures, work force, and material. Preexisting facilities are used to the maximum extent possible. If preexisting facilities are not available, the PM will coordinate with the engineer coordinator for the construction of a facility based on existing designs in the Theater Construction Management System database. (See appendix J.)

PROCESSING, CLASSIFICATION, AND IDENTIFICATION REQUIREMENTS

7-10. Processing, classification, and identification requirements for U.S. military prisoners are critical when operating a confinement facility. Accurate documentation allows the classification and identification process to run smoothly.

PROCESSING

7-11. . Each time the control of a U.S. military prisoner is transferred, the receiving organization acknowledges receipt of the prisoner and his property using DD Form 2708 and DA Form 4137.

7-12. Prisoners begin their confinement by in-processing into the FCF. In-processing is typically conducted by an I/R company prisoner operations section. Part of the in-processing procedure is to assist the prisoners' integration into the confinement environment. Newly confined prisoners are processed according to guidelines to ensure that—

- DD Form 2707 is accurate.
- Property is searched and segregated (authorized and unauthorized).
- Prisoners are strip-searched.
- Prisoners are issued the appropriate health and comfort supplies and complete a DD Form 504 (*Request and Receipt for Health and Comfort Supplies*).
- Prisoners are photographed and fingerprinted.
- All documentation is complete. If available, use the Army Corrections Information System Centralized Operations Police Suite. (See AR 190-47.)
- Prisoners are informed of mail and visitation rights.

7-13. A medical officer examines each prisoner within 24 hours of confinement and completes DD Form 503. Newly confined prisoners are segregated from other prisoners while they undergo initial processing. Tattoos, scars, and identifying marks are noted on DD Form 2710 (Inmate Background Summary). The prisoner's personal property (such as clothing, money, official papers, and documents) is examined.

7-14. Newly confined prisoners complete training that is designed to explain facility rules and regulations, counseling procedures, UCMJ disciplinary authority and procedures, and work assignment procedures as soon as possible. The rights of prisoners and the procedures governing the presentation of complaints and grievances according to AR 20-1 are fully and clearly explained. Pretrial prisoners are carefully instructed as to their status, rights, and privileges. They participate in the correctional orientation or treatment program phases that are determined necessary by the facility commander to ensure custody and control, employment, training, health, and welfare. Confined officers and NCOs do not exercise command or supervisory authority over other individuals while confined, and they comply with the same facility rules and regulations as other prisoners. They are not permitted special privileges that are normally associated with their former rank.

CLASSIFICATION

- 7-15. U.S. military prisoners in an FCF are classified into two categories—pretrial and posttrial:
- Pretrial prisoners must be segregated from posttrial prisoners. Pretrial prisoners must be further segregated, by gender, into the following categories: officers, NCOs, and enlisted. Pretrial prisoners are individuals who are subject to trial by court-martial and have been ordered by competent authority into pretrial confinement pending disposition of charges.
 - Posttrial prisoners are individuals who are found guilty and sentenced to confinement. Posttrial prisoners include in-transit prisoners who are evacuated to another facility and prisoners retained at the FCF during short-term sentences.

IDENTIFICATION

7-16. Individual identification photographs are taken of all prisoners. The prisoner's last name, first name, and middle initial are placed on the first line of a name board, and the prisoner's social security number is placed on the second line. A prisoner registration number may be added on the third line. Two front and two profile pictures are taken of the prisoner. Fingerprints are obtained according to AR 190-47.

CLOTHING, MEALS, AND DINING FACILITIES

7-17. One of the many challenges that military police commanders and leaders face when operating a facility is ensuring that the basic treatment standards for U.S. military prisoners are met and sustained to include, but not limited to—

- Proper clothing for all seasons and types of weather.
- Meals that are properly rationed and distributed.

7-18. Special security concerns are a factor for dining facilities. Military police who are guarding U.S. military prisoners must always be vigilant in areas where prisoners congregate, such as a dining facility.

7-19. Prior planning is critical to establishing a good system of supply needs and demands to ensure that those requirements are fulfilled.

CLOTHING

7-20. Prisoners confined in an FCF wear the uniform of their respective military service. Certain items of clothing (as prescribed in AR 700-84) and other articles (as determined by the facility commander) are returned to the prisoner. Rank insignia is not worn at the place of confinement. The issue and expense of clothing supplied to prisoners, except officers, is according to AR 700-84 and Common Table of Allowance (CTA) 50-900. DA Form 3078 (*Personal Clothing Request*) is maintained for personnel with less than 6 months of active duty service and personnel receiving clothing on an issue-in-kind basis. Organizational clothing, within the allowances prescribed in CTA 50-900, may be provided to prisoners according to AR 710-2. Prisoner clothing, except for officers on pay status, is laundered or dry cleaned without charge. (See AR 210-130.) (Clothing and personal property is dispositioned according to AR 190-47.)

MEALS

7-21. Prisoners are provided with wholesome and sufficient food prepared from the Army Master Menu. They are normally supplied with the full complement of eating utensils. (The FCF commander must approve the nonissue of eating utensils for security or other reasons. Prisoners in close confinement and those with loss of privileges associated who have approved disciplinary action may be denied supplemental rations described on the Army Master Menu.) Alternate meal control procedures may be authorized by the FCF commander or a designated representative as a means to prevent staff and prisoner injury when a prisoner may have tampered with food. These procedures require documentation on DA Form 3997 and the concurrence of a medical officer. Meal control procedures will not exceed 7 days.

DINING FACILITIES

7-22. Dining facilities may be organic to the unit operating the FCF or set up through appropriate contracting procedures. The FCF commander decides the best method for feeding the prisoners based on the available dining facilities and logistical and HN support.

MEDICAL CARE AND SANITATION

7-23. Medical personnel supporting an FCF assist in providing medical and mental health care, referrals, limited counseling, and social services. Medical officers, clinician nurses, or physician's assistants perform medical examinations to determine the fitness of newly confined prisoners and prisoners who have been outside military control for more than 24 hours. These examinations are completed within 24 hours of a prisoner's initial arrival or return to confinement. Examinations normally take place at the FCF. Dental services are provided, as required, for all prisoners. A medical officer, clinician nurse, or physician's assistant examines each prisoner in close confinement daily. Except in matters requiring the protection of medical information, the facility commander is provided with medical observations and recommendations concerning individual prisoner's correctional treatment requirements.

7-24. Prisoners are tested for HIV and screened for tuberculosis within 3 duty days of their initial confinement. The results of the HIV test and the tuberculosis screening are recorded on DD Form 503.

7-25. The medical commander or a designated representative (typically, a preventive medicine personal) performs a monthly inspection of the FCF. This inspection ensures that the operation of the FCF is consistent with accepted preventive medicine standards. The FCF commander is provided with a copy of the inspection results at the time of the inspection. (Additional medical guidance is provided in AR 190-47.)

7-26. The FCF commander must enforce high sanitation standards within the facility. Preventive medicine personnel will provide direct oversight and support to field sanitation teams as necessary.

7-27. All prisoners are required to bathe and follow basic personal hygiene practices while in custody to prevent communicable diseases. The FCF commander must enforce high sanitation standards in FCFs where prisoners are required to share common latrines and showers.

DISCIPLINE, CONTROL, AND ADMINISTRATION

7-28. Developing discipline, control, and administrative procedures for military police operating confinement facilities is crucial to the success of U.S. military prisoner operations. Military police leaders ensure that appropriate procedures, consistent with U.S. laws and policies, are in place to guide and direct personnel operating those facilities. Such procedures ensure that prisoners are allowed the full range of privileges afforded to persons with their status when the consistent application of facility standards is applied.

DISCIPLINE

7-29. FCF commanders are authorized by public law and AR 190-47 to restrict the movement and actions of prisoners, take other actions required to maintain control, protect the safety and welfare of prisoners and other personnel, and ensure orderly FCF operation and administration.

Note. A prisoner is considered to be in an on-duty status except for periods of mandatory sleep and meals and during reasonable periods of voluntary religious observation as determined by the facility commander and in coordination with the facility chaplain. Therefore, a prisoner who, as part of an administrative disciplinary action, has been determined undeserving of recreation time privileges may be required to perform other duties during such time. Such performance of duties is not considered a performance of extra duty. Privileges will be withheld from prisoners on an individual basis, without regard to custody requirements or grade and only as an administrative disciplinary measure authorized by AR 190-47. The attractiveness of living quarters and the type or amount of material items that may be possessed by prisoners may differ by custody grade to provide incentives for custody elevation. Prisoners are denied the privilege of rendering the military salute. Pretrial prisoners salute when they are in an appropriate Service uniform.

7-30. The only authorized forms of administrative disciplinary action and punishment administered to military prisoners are described in AR 190-47 and the UCMJ. Procedures, rules, regulations, living conditions, and similar factors affecting discipline are constantly reviewed to determine disciplinary action. Physical or mental punishments are strictly prohibited. Authorized administrative disciplinary actions include—

- Written or oral reprimand or warning.
- Deprivation of one or more privileges. Visits may be denied or restricted as a disciplinary action only when the offense involves violations of visitation privileges. Restrictions on mail will not be imposed as a disciplinary measure.
- Extra duty on work projects that may not exceed 2 hours per day for 14 consecutive days. Extra duty will not conflict with regular meals, sleeping hours, or attendance at regularly scheduled religious services.
- Reduction of custody grade.
- Disciplinary segregation that does not exceed 60 consecutive days. Prisoners are told why they are being placed in segregation and that they will be released when the segregation has served its intended purpose. Segregated prisoners receive the same diet as prisoners who are not segregated. Nonessential items, such as soft drinks and candy, in addition to the diet stipulated by the Army Master Menu are not provided.
- Forfeiture of all or part of earned military good conduct time or extra good conduct time according to AR 633-30 and DOD 1325.7. A forfeiture of good conduct time need not be specified as to whether it is from good conduct time or extra good conduct time.

7-31. The FCF commander is authorized to administer punishment, he or she may delegate this authority to a subordinate officer (captain or above) for minor punishments. The first field-grade commander in the

chain of command imposes major punishment when delegated authority by the first general officer in the chain of command. Prohibited punitive measures include, but are not limited to—

- Clipping a prisoner's hair excessively close.
- Instituting the lockstep.
- Requiring silence at meals.
- Having prisoners break rocks.
- Using restraining straps and jackets, shackles, or hand or leg irons as punishment.
- Removing a prisoner's underclothing or clothing and instituting other debasing practices.
- Flogging, branding, tattooing, or any other cruel or unusual punishment.
- Requiring strenuous physical activity or requiring a prisoner to hold a body position designed to place undue stress on the body.
- Using hand or leg irons, belly chains, or similar means to create or give the appearance of a chain gang.

WARNING

Prisoners will not be fastened to a fixed or stationary object

7-32. Prohibited security measures include, but are not limited to—

- Employing chemicals (except riot control agents).
- Employing machine guns, rifles, or automatic weapons at guard towers, except as a means to protect the FCF from enemy or hostile fire. Selected marksmen, equipped with rifles, may be used as part of a disorder plan when specifically authorized by the higher echelon commander (other than the FCF commander).
- Using electrically charged fencing.
- Securing a prisoner to a fixed object. This is prohibited except in emergencies or when specifically approved by the facility commander to prevent potential danger to FCF staff and/or the outside community. Medical authorities should be consulted to assess the health risk to prisoners.
- Using MWDs to guard prisoners.

Note. The FCF commander must follow additional guidance and procedures for disciplinary measures as outlined in AR 190-47.

CONTROL

7-33. The FCF commander follows the custody and control guidelines outlined in AR 190-47. The facility commander or a designated representative conducts physical counts of prisoners each day. The report rendered by the inspecting officer includes verification of DD Form 506 (*Daily Strength Record of Prisoners*). Physical counts will at a minimum include—

- Roll call or a similarly accurate accounting method at morning, noon, and evening formations.
- Head count immediately on the return of prisoners from work details.
- Bed checks between 2300 and 2400 and between 2400 and 0600.

7-34. The appropriate degree of custodial supervision for individual prisoners is based on a review of all available records pertaining to the prisoner, including DD Form 2713, DD Form 2714, DODI 1325.7, and the recommendations of correctional supervisors and professional services support personnel. Prisoners are not assigned to a permanent custody grade based solely on the offenses for which they were confined. Classification is to the minimum custody grade necessary and is consistent with sound security requirements and DODI 1325.7. Custody grades include trustee and minimum, medium, and maximum security. FCF commanders may subdivide these custody grades to facilitate additional security controls.

ADMINISTRATION

7-35. The commander and staff of an I/R company or battalion will typically operate an FCF. The following duties are performed in addition to the personnel and services requirements during processing:

- **Shift supervisor.** The shift supervisor keeps the FCF commander informed on matters that affect the custody, control, and security of the FCF. The FCF commander must select a shift supervisor who has direct supervision over correctional and custodial personnel within the FCF. Shift supervisors ensure that rules, regulations, and SOPs are followed and enforced. They directly supervise facility guards and are responsible for prisoner activities. They monitor custody and control and security measures, ensure compliance with the scheduled calls, initiate emergency control measures, and are responsible for the FCF DA Form 3997. Supervisory personnel assigned to the FCF may also perform these duties.
- **Facility guards.** Facility guards work for the shift supervisor and are responsible for the custody, control, and discipline of prisoners under their supervision. They supervise activities according to the schedule of calls and supervise the execution of emergency action plans. They conduct periodic inspections, searches, head counts, roll calls, and bed checks. Table 7-1 depicts the duties that facility guards must perform.

7-36. The FCF commander ensures that a complete and current set of regulations governing corrections and confinement facilities is available. These regulations include, but are not limited to—

- AR 15-130.
- AR 190-14.
- AR 190-47.
- AR 633-30.
- DODI 1325.7-M.
- DODI 7000.14-R.
- MCM.
- UCMJ.

Table 7-1. Facility guards' duties and actions

Duties	Actions
Close-confinement	Close-confinement Soldiers maintain custody and control of prisoners who are segregated from the general population due to inprocessing, administrative reasons, or disciplinary reasons. They ensure that activities are accomplished within the schedule of calls applicable to the close-confinement area. When DD Form 509 is required, close-confinement Soldiers are responsible for ensuring that 30-minute checks are conducted. Special-status prisoners are checked every 15 minutes. Prisoners considered suicide risks are observed continuously. Guards ensure that all required signatures for DD Form 509 are obtained on a daily basis.
Dining facility	Dining facility Soldiers are responsible for the custody and control of prisoners during mealtimes. They ensure that the dining facility traffic plan is followed to prevent prisoner congestion at high-traffic areas. Silverware is counted before and after the meal. Prisoners are searched before leaving the dining facility.
Detail supervisors	Detail supervisors maintain custody, control, and supervision of prisoners while on assigned details. They ensure that work is completed and that safety precautions are observed. They maintain strict accountability of equipment and tools. Detail supervisors assist with frisking and/or strip-searching prisoners who are returning from details. They account for prisoners on details according to the schedule of calls. They track the prisoners' locations at all times while they are on a detail.
Prisoner escorts	Prisoner escorts provide custody and control while moving prisoners to and from designated places. If required and authorized by the facility commander, each may be armed with a pistol. If available, a guard company may perform these duties. If armed, escorts will be qualified with a pistol and trained in the UOF; ROE; and firearms safety procedures for transporting prisoners by land, air, and sea.
Main gate and/or sally port	Soldiers assigned to the main gate and/or sally port ensure that only authorized persons enter the FCF, provide custody and control of prisoners, and inspect vehicles entering and leaving the FCF. They provide security by inspecting packages, conducting inventories of items entering and exiting the facility, and requiring noncustodial personnel to register on sign-in logs. A guard company may perform these duties if available.
Visitor room	Visitor room Soldiers are responsible for the custody and control of prisoners during visits authorized by the FCF commander. They are to detect violations of rules and regulations, improper behavior, and contraband delivery. They position themselves in an inconspicuous place and observe the conversations rather than listen to them. Any identified infractions are reported to the shift supervisor and may be grounds for termination of the visit.
Hospital	Hospital Soldiers provide custody and control while escorting prisoners to and from medical appointments and during specified hospitalization. They ensure that rooms are clear of contraband and prevent unauthorized communications with other individuals. A guard company may perform these duties if available.
Tower watch	Soldiers assigned to duty in towers provide custody and control by observing specific sectors of the perimeter. They Soldiers are briefed on the UOF and are qualified with the 12-gauge shotgun and/or their assigned weapon. They ensure that contraband is not passed through the fence and provide protection for Soldiers in the compound/enclosure.
Note. The facility commander may adjust the number and types of guards based on available personnel.	
Legend:	
DD	Department of Defense
FCF	field confinement facility
ROE	rules of engagement
UOF	use of force

7-37. The FCF commander must maintain a number of records and reports to facilitate administrative operations. (See appendix G for a complete list of records and reports.)

7-38. A correctional treatment file is established within the first 72 hours of initial confinement and maintained throughout a prisoner's confinement period. If a prisoner is transferred, this file accompanies

him or her to the next facility. AR 190-47 establishes the minimal requirements for the correctional treatment file.

7-39. The FCF commander may have to consider sentence computations if the theater commander determines that certain sentences will be served within the theater. This decision is based on the type of operation and its projected duration. Sentence computation is conducted according to AR 633-30 and DOD 1325.7-M. The FCF commander ensures that the personnel services NCO working in the personnel staff officer is properly trained to do sentence computations. Incorrect computations will result in incorrect release dates and can violate a prisoner's legal rights. The rate of earnings for good conduct time is calculated based on the prisoner's length of confinement, to include any pretrial time. (See Table 7-2 for information on good conduct time for prisoners who have been found guilty of an offense that occurred on or after 1 October 2004.)

Table 7-2. Good conduct time

Sentence	Good Conduct Time
<1 year	5 days for each month
≥1 year to <3 years	6 days for each month
≥3 years to <5 years	7 days for each month
≥5 years to <10 years	8 days for each month
≥10 years (excluding life)	10 days for each month
Note. If the term of confinement is reduced or increased, time for good conduct is recomputed at the rate appropriate to the new term of confinement.	

Mail and Correspondence

7-40. The FCF staff records the inspection of each prisoner's mail, correspondence, and authorized correspondents on DD Form 499 (*Prisoner's Mail and Correspondence Record*). The mail and correspondence guidance outlined in AR 190-47 applies to the battlefield confinement of U.S. military prisoners.

Prisoner Personal Property and Funds

7-41. Prisoners in the FCF are allowed to place personal property that the FCF commander has not authorized for personal retention in safekeeping. Prisoner personal property and funds guidance outlined in AR 190-47 applies to the battlefield confinement of U.S. military prisoners.

Support Personnel

7-42. Support personnel organic to the unit operating the FCF are tasked with providing support to the FCF. Special personnel (medical officer, chaplain, social service worker), may also be available to assist with the administration of the facility. Support personnel assigned to an FCF are oriented and trained in the procedures of custody and control. A formal training program is established that may include, but is not limited to—

- Supervisory and interpersonal communication skills.
- Self-defense techniques.
- Use of force.
- Weapons qualifications. (See DA Pamphlet 350-38.)
- First aid.
- Emergency plans.
- FCF regulations.
- Riot control techniques.

Supply Services

7-43. Supply functions for units operating the FCF are the same as in other military operations. However, more emphasis is placed on security measures and accountability procedures that are necessary to prevent certain supplies and equipment from falling into the hands of prisoners.

7-44. Weapons, ammunition, and emergency equipment (such as hand and leg irons) must be stored in maximum-security, locked racks and cabinets. These racks and cabinets are then placed in a room that is located away from prisoner areas.

7-45. The unit logistics officer ensures that a sufficient amount of general use and janitorial items are available to keep the FCF sanitary and free of potential diseases. General-use items include mops, buckets, brooms, toiletries, and office supplies. These items are issued under strict control procedures and on an as-needed basis to prisoners and staff. Health and comfort items are issued to new prisoners during the initial processing and regularly thereafter. Prisoners request additional supplies using DD Form 504. Prisoners in a nonpay status receive these items free of charge. Basic health and comfort supplies include, but are not limited to, safety razor, bath soap, toothbrush, toothpaste, and shoe polish.

7-46. Physical inventories are conducted at least monthly to reconcile and balance the records of the previous inventory, supplies received, and supplies issued to prisoners. The FCF commander or a designated representative verifies the inventory in writing.

EMERGENCY PLANNING AND INVESTIGATIONS

7-47. The FCF commander publishes formal plans for apprehending escaped prisoners, protecting and preventing fires, evacuating the FCF (in CBRNE and regular scenarios), quelling prisoner riots and disorders, evacuating mass casualties, quarantining U.S. military prisoners, and conducting special confinement and U.S. military prisoner processing operations. These plans must form part of the unit SOP and be tailored to the physical environment where the FCF is located. Emergency action plans are tested at least every 6 months. Evacuation drills (such as fire drills) are conducted monthly. All tests of the emergency action plans in the FCF are recorded on DA Form 3997. (See DODI 6055.6 and FM 5-415.) The essential elements of these plans include—

- Providing notification by alarm and confirming the nature of the situation.
- Providing procedures for manning critical locations on the exterior of the FCF (control points, escape routes, observation points, defensive positions).
- Providing procedures to secure the prisoner population during the execution of emergency action plans.
- Instituting prisoner and cadre recall procedures and developing a means of organizing forces (for example, search parties and riot control teams).
- Implementing procedures to terminate the emergency action plan and conducting follow-up actions (submitting reports, conducting an investigation).
- Providing procedures for evacuating mass casualties and securing prisoners.

7-48. The FCF commander is responsible for organizing a reaction force that is trained in the use of force, riot control formations, and other emergency actions. The size of the reaction force depends on available personnel assets and the nature of the emergency.

7-49. Where appropriate or legally required, incidents of misconduct, breaches of discipline, or violations of the UCMJ are investigated using the procedures established in AR 15-6. Before prisoners suspected or accused of violations are interviewed, advised of their rights against self-incrimination under Article 31, UCMJ, and told that any statement they make may be used as evidence against them in a criminal trial or in a disciplinary and adjustment board proceeding. They are told that they have the right to counsel and to have counsel present during questioning. Requests to consult with counsel will not automatically result in the case being referred to a three-member board. If requested, arrangements are made for the prisoner to meet with an attorney as soon as practical. Relevant witnesses, including those identified by U.S. military prisoners, are interviewed as deemed appropriate by the investigator. Written, sworn statements are

obtained when possible. The investigation is completed expeditiously, and a disciplinary report is submitted to the FCF commander or a designated representative.

7-50. Upon receipt of the disciplinary and adjustment board report, the senior board member takes action to reduce the report to a memorandum for record, refers the case for counseling and/or reprimand, or takes other appropriate action. (Refer to AR 190-47 for further guidance on a disciplinary and adjustment board.)

RULES OF INTERACTION

7-51. The FCF commander must establish and enforce the ROI that allow for the humane treatment and care of prisoners, regardless of the reason they are confined ROI include, but are not limited to—

- Being professional and serving as positive role models for prisoners.
- Being firm, fair, and decisive.
- Refraining from being too familiar or too belligerent with prisoners.
- Avoiding becoming emotionally or personally involved with prisoners.
- Not gambling, fraternizing, or engaging in any commercial activities with prisoners.
- Not playing favorites with any prisoners.
- Not giving gifts to prisoners or accepting gifts from them.

USE OF FORCE

7-52. Guidelines on the use of force are incorporated into orders, plans, SOPs, and instructions at FDFs and FCFs. In all circumstances, employ only the minimum amount of force necessary. The use of firearms or other means of deadly force is justified only under conditions of extreme necessity and as a last resort. No person will use physical force against a prisoner except as necessary to defend themselves, prevent an escape, prevent injury to persons or damage to property, quell a disturbance, move an unruly prisoner, or as otherwise authorized in AR 190-47.

7-53. In the event of an imminent group or mass breakout from the FCF or another general disorder, it should be made clear to prisoners that order will be restored, by force if necessary. If the situation permits, a qualified senior NCO or the facility commander will attempt to reason with prisoners engaged in the disorder before the application of force. If reasoning fails or if the existing situation does not permit reasoning, a direct order will be given to prisoners to terminate the disorder. Before escalating beyond a show of force, prisoners not involved in the disturbance may be given an opportunity to voluntarily assemble in a controlled area away from the disturbance. (See appendix H.)

ESCAPE

7-54. Each guard is provided with a whistle or another suitable means of audible alarm. Using firearms to prevent an escape is justified only when there is no other reasonable means to prevent escape. (See AR 190-14.) In the event that a prisoner attempts to escape from the confines of the FCF, the guard takes action according to the following priorities:

- Alerts other guard personnel of the attempted escape by blowing three short blasts on a whistle or by sounding another suitable alarm signal.
- Orders the prisoner to halt three times in a loud voice.
- Fires only when the prisoner has passed all barriers of the FCF and is continuing the attempt to escape.

7-55. The location of barriers is determined by the physical arrangement of the FCF. Normally, barriers include fences or walls enclosing athletic, drill, recreational, and prisoner housing areas and administrative buildings.

7-56. A guard does not fire on an escapee if the action of firing will endanger the lives of other persons. When firing is necessary, the guard directs shots at the prisoner with the intent to disable rather than to kill. Guidelines for the use of firearms by guards escorting prisoners outside the FCF are generally the same as those for the use of firearms at the FCF. (See AR 190-47.)

7-57. The FCF commander ensures that guards are trained to use the weapons with which they are armed. All personnel are thoroughly trained on policies regarding the use of force and the provisions of AR 190-14. Only 12-gauge shotguns with cylinder (unchoked) barrels are issued for use by FCF guards, and barrels will not exceed 20 inches in length. Authorized ammunition for armed guards (perimeter and escort guards) is Number 9 shot in trap loads of 2¾ drams equivalent of power and 1½ ounces of shot. Tower guards may use 00 buckshot ammunition.

7-58. Tower guards and escort guards are instructed that the shotgun will not be fired at a range of less than 20 meters to prevent prisoner escapes. Such instructions will appear in prisoner guard training programs and in special instructions prepared for guard personnel.

7-59. The M9 pistol and M16 and/or M4 rifles are used when prisoners are under escort. Machine guns and submachine guns are not to guard U.S. military prisoners. Weapons are not taken inside controlled areas of the FCF, except at the expressed direction of the FCF commander.

TRANSPORTATION

7-60. The FCF commander is responsible for prisoner transportation requirements, to include safety and security once a prisoner is under the FCF commander's direct custody. (See chapter 4 for more information on transportation considerations.) The FCF commander must ensure that the guard and escort force is thoroughly familiar with the RUF and the movement tasks outlined in STP 19-31E1-SM. The FCF commander ensures that escort guards—

- Know the type of vehicle being used, departure time, number of prisoners and their status, the number of assigned escorts, the type of weapons they are armed with, type of restraints used (if applicable), and transfer procedures at the final destination.
- Know the actions to take in the event of a disorder or an escape attempt.
- Conduct a thorough vehicle search and ensure that items which could be used as weapons are removed or secured.
- Do not handcuff two prisoners together if they are both at risk for escape.
- Do not handcuff prisoners to any part of a vehicle.
- Sign a DD Form 2708 for each prisoner escorted out of the FCF and frisk the prisoners before loading them into the vehicle.
- Follow loading procedures based on the type of transport available.
- Know emergency, loading, unloading, latrine, and meal procedures.

TRANSFER AND DISPOSITION OF U.S. MILITARY PRISONERS

7-61. The FCF commander must be prepared to transfer U.S. military prisoners from their facilities to other confinement facilities outside the theater or back to their units. Receiving units are responsible for the movement of prisoners. Prisoners are only released from confinement with proper authorization. The FCF commander coordinates with SJA and the next higher commander to determine release authority and authenticate DD Form 2718 (*Inmate's Release Order*). (Detailed guidance on the administrative and operational processing required for prisoner transfer is outlined in AR 190-47.)

This page intentionally left blank.

Chapter 8

Rehabilitation of U.S. Military Prisoners and Detainees

The rehabilitation of U.S. military prisoners has long been practiced, but it has only recently become a focus for detainees. Lessons learned have highlighted this critical requirement, and military police have been actively involved in a complete reengineering of apprehension, detention, and release procedures for detainees as a result. These new detention procedures are based on rehabilitation and reeducation programs for Islamic extremists developed in Singapore and Saudi Arabia and incorporate lessons learned from Abu Ghraib and other recent and historical U.S. involvement with detainee operations. The rehabilitation procedures also draw from established policies and procedures for rehabilitation that are already effectively employed for U.S. military prisoners. The rehabilitation of detainees plays a critical role in counterinsurgency operations and benefits the overall counterinsurgency strategy.

REHABILITATION

8-1. Issues of apprehension, incarceration, recidivism, and programs to curb violent behavior in released persons is a long-studied subject by generations of scholars. Entire organizations are built around these issues and take years of in-depth analysis to reach conclusions for policy application. This is further complicated by the conditions in a combat zone.

8-2. Detention provides military police with an opportunity for interaction and positive influence on U.S. military prisoners and detainees. Military police provide humane and even-handed treatment to prisoners and detainees in their care. These persons are within the control of military police under circumstances that, unchecked, could cause military police to regard them with great animosity. It is the professionalism and discipline of military police that facilitates impartial conduct toward prisoners and detainees and prevent animosity from manifesting itself. This, in turn, sends a clear message of fairness and impartiality toward the indigenous people. Military police internment operations in support of long-term stability operations, particularly within the context of counterinsurgency, must be deliberately and professionally conducted with an understanding of the impact of perception and subsequent negative information operations used by the threat to discredit the U.S. military.

8-3. Detention or imprisonment can be a period of transitory idleness where the U.S. military prisoner or detainee simply endures the period of his internment and contemplates the humiliation or perceived injustice of his condition. Conversely, it can be one of the most productive and auspicious rehabilitative measures that society can provide the individual and his respective society. Rehabilitative measures have resulted in decreased recidivism and should begin the moment the individual is apprehended or captured and fully implemented upon transfer to a fixed facility.

8-4. U.S. military prisoners and detainees are afforded selected privileges, such as sending and receiving correspondence or employment opportunities for compensation. The presumption is that U.S. military prisoners and detainees receive these benefits unless the commander determines that a modification of the privileges is required by a violation of camp discipline or (in the case of CIs, unlawful enemy combatants or U.S. military prisoners) for imperative reasons of security. Commanders and operation officers consult with the local servicing SJA or legal advisor when determining whether to withhold the above stated activities from any U.S. military prisoner or detainee.

SECTION I – U.S. MILITARY PRISONERS

PROGRAMS

8-5. All prisoners (unless precluded because of disciplinary, medical, or other reasons determined appropriate by the facility commander) engage in useful employment that is supplemented by appropriate supervision, mental health programs, professional evaluation, education, training, and welfare activities. Activities established and resources allocated to meet these requirements are not to be less arduous or more generous than for military personnel who are not incarcerated.

CLASSIFICATION

8-6. Correctional evaluation and classification are based (at a minimum) on an individual prisoner's offense, attitude, aptitude, intelligence, personality, adaptation to incarceration, record of performance before incarceration, and potential for further military service. (See DODI 1325.7.)

PLANS, POLICIES, AND PROCEDURES

8-7. The facility commander establishes an inmate classification plan that covers policies and procedures for inmate classification. The plan specifies objectives and methods for achieving goals, to include monitoring and evaluating the classification process. The plan is reviewed and updated annually. The classification plan, at a minimum, contains and/or implements the following:

- Assessment of a prisoner's adjustment to and progress of confinement.
- Assignment to a staff member/team to ensure supervision and personal contact.
- Review of prisoner's classification at least annually.
- Criteria and procedures for determining and changing an inmate's classification status, to include at least one level of appeal.
- Notice to all prisoners 48 hours in advance to appear at their classification hearing and are given notice before the hearing, unless the potential security of the facility or others is at serious risk.
- Opportunity for prisoners to request and receive authorization from the facility commander or his designated representative to review the progress and classification status as noted on the DD Form 2712 (*Inmate Work and Training Evaluation*).
- Risk assessment of the inmate.

Review Board

- 8-8. The facility commander establishes classification review boards that—
- Consider and make recommendations to the facility commander or a designated representative regarding each prisoner's correctional treatment program, including custody grade, quarters, training, work, planned disposition, and special treatment.
 - Review background information and consider cases of prisoners to determine their individual correctional treatment program and initial assignment.
 - Conduct special reviews when directed by the facility commander.
 - Report findings, recommendations, and actions taken by the facility commander or a designee by using the prisoner classification review and DD Form 2711-1 (*Custody Reclassification*).
 - Divulge recommendations only to persons with a need to know.

8-9. Classification review boards consist of an E-8/general schedule (GS)-12 or above with two enlisted members (E-6 or above). A GS-7 may be substituted for one of the NCO members. (See AR 190-47.)

DISPOSITION BOARDS

- 8-10. The facility commander establishes disposition boards to perform functions that include—
- Considering and making recommendations to the facility commander regarding clemency actions and requests for parole.
 - Conducting work per policies established in AR 190-47.

- Following procedures established by the facility commander.
- Preparing a mental health report (documented by mental health personnel) for each prisoner appearing before the board who is confined for murder, rape, aggravated assault, aggravated arson, sexual offenses, child abuse, or an attempt to commit any of these offenses.
- Ensuring receipt of current recommendations by the disposition board and the facility commander not earlier than 30 days in advance a prisoner's maximum eligibility date for consideration by the secretary of the Service concerned. Disposition evaluations and recommendations being submitted for annual consideration will be forwarded 30 days in advance of annual consideration dates. Minimum eligibility dates for consideration will be determined per references cited in DODI 1325.7. The disposition board will consider prisoners for restoration or reenlistment, clemency, and parole. The board will make a recommendation regarding restoration or reenlistment only if the prisoner has applied for restoration or reenlistment.
- Making recommendations regarding clemency for each prisoner requesting consideration. Consideration for parole will be per AR 15-130 and chapter 8 of AR 190-47. Annual clemency and parole review dates will occur per AR 15-130, except when an interim consideration for parole or clemency is directed. When interim consideration occurs, a new annual review date will be established as of the date of the interim consideration. When action on restoration/reenlistment, clemency, or parole has been taken, the prisoner will be promptly informed of the decision.

8-11. Disposition boards consist of an E-8/GS-10 or above with two enlisted members (E-6 or above). A GS-7 may be substituted for one of the NCO members. When requested by the respective Service, a member of the prisoner's Service will be a board member. If a member of the Navy or Coast Guard is not available, a Marine will usually sit as a board member. (See AR 190-47 for more information on disposition boards.)

COUNSELING

8-12. Counseling is a continuous process, that often involves every member of the staff and cadre. While various counseling programs may be available, no prisoner is guaranteed participation in any specific counseling or treatment program.

8-13. Army Corrections System facilities establish prisoner counseling programs that are commensurate with staffing levels and the policies set forth in AR 190-47. Counseling is available in all facilities for immediate problem solving and crisis intervention. Army Corrections System regional facilities and the U.S. disciplinary barracks provide the following counseling/treatment programs:

- Chemical abuse counseling.
- Anger management counseling.
- Stress management training.
- Adjunct therapy programs such as Alcoholics Anonymous and Narcotics Anonymous.
- Impact of crimes on victims training.
- Other programs consistent with staffing, professional support, and prisoner needs.

8-14. Regional corrections facilities will rely primarily on those counseling/treatment programs available to all Soldiers. Installations unable to provide basic regional counseling services will request a waiver from the OPMG.

EMPLOYMENT

8-15. Another element of the correctional program involves employing U.S. military prisoners. (See AR 190-47 for more information on U.S. military prisoner employment.) Several considerations involved with employment include—

- **Nature of work.** Prisoners are employed in maintenance and support activities that provide work of a useful, constructive nature that is consistent with their custody grade, physical and

mental condition, behavior, confining offense, sentence status, previous training, individual correctional requirements, and installation or facility needs.

- **Coordination of work projects.** Close coordination between the facility commander and the garrison commander or equivalent is maintained to establish worthwhile work projects for the employment of prisoners. Approval for, and assignment of, prisoners to work on projects are the responsibilities of the facility commander.
- **Employment activities.** Prisoners may be employed in the manufacturing and processing of equipment, clothing, and other useful products and supplies for DOD activities or other federal agencies; in agricultural programs; manufacturing; or the preparation of items to meet institutional or installation needs.
- **Vicinity of work.** Prisoners cannot work away from the installation or subinstallation on which the facility is located, except as part of an approved work release program, or upon the facility commander's approval.
- **Length of workday.** When not engaged in prescribed training or counseling, prisoners are required to perform a full day of useful, constructive work. In general, prisoners are employed through a standard 40-hour workweek. Supervisors may determine that failure to complete 40 hours was due to factors outside the control of the prisoner, such as weather, sickness, and so on. This restriction is not intended to limit the authority of commanders to direct extra work during emergencies, to prevent the assignment of prisoners to details that normally encompass weekends, or to prevent prisoners from volunteering for extra work.

Work Restrictions

8-16. Commanders are aware of the following restrictions while employing military prisoners:

- A pretrial prisoner will not be assigned work details with posttrial prisoners.
- Prisoners will not perform the following work detail:
 - Attend children.
 - Exercise dogs (except as part of authorized duties on properly established and recognized work details).
 - Clean and polish others' shoes (except in shoe repair and shoe shine projects operated by an Army Corrections System facility).
 - Perform laundry work (except in the installation or Army Corrections System facility laundry).
 - Act as cooks or serve meals in individual quarters.
 - Cultivate or maintain private lawns or gardens.
 - Make beds or perform orderly or housekeeping duties in government or privately owned quarters.
- Prisoners will not perform labor that results in financial gain to prisoners or other individuals, except as specifically authorized by the garrison or Army Corrections System facility commander.
- Prisoners will not be given work assignments that require the handling of, or access to, personnel records, classified information, drugs, narcotics, intoxicants, arms, ammunition, explosives, money, or institutional keys.
- Prisoners will not have access to automation equipment unless approved by the Army Corrections System facility commander and properly supervised.
- Prisoners are required to perform useful work to the same extent as Soldiers who are available for general troop duty. However, they will not be used on work such as police details, area maintenance, janitorial duties, or kitchen police within unit areas. Such work projects may be performed in direct support of the Army Corrections System facility and other installation functions when approved by the garrison commander or equivalent.
- Prisoners will not be placed in any position where the discharge of duties may reasonably be expected to involve the exercise of authority over other prisoners. However, skilled prisoners

may be used as assistant instructors to help other prisoners with academic work and vocational education or training.

Note. Prisoners may work in exchanges, clubs, or other service-regulated activities on a military installation, provided such employment does not violate the prohibited practices listed above.

Compensation

8-17. Prisoners in a nonpay may be compensated for demonstrating excellence in work, as follows:

- **Appropriated funds.** When authorized by public law or an AR, appropriated funds available to the Army Corrections System facility may be used to pay prisoners for work performed. When pay is authorized, the Deputy of the Army PM will issue a specific pay-for-work policy.
- **Good conduct time.** Good conduct time is accorded each prisoner serving a sentence(s) imposed by a court-martial or other military tribunal for a definite terms of confinement. Prisoners who are serving a life sentence will not receive good conduct time. Good conduct time is credited monthly with a deduction from the term of sentence(s) beginning with the day that the sentence begins. Military services may elect to calculate an anticipated release date at the beginning of a prisoner's sentence to confinement based on the regular good conduct time that could be earned for the entire period of the sentence. A parole/mandatory supervised release violator who is returned to confinement earns good conduct time at the rate applicable to the sentence in effect at the time of violation of parole/mandatory supervised release. Good conduct time will be credited according to AR 633-30 and at the rates described below:
 - Five days for each month of the sentence if the sentence is less than 1 year.
 - Six days for each month of the sentence if the sentence is at least 1 year but less than 3 years.
 - Seven days for each month of the sentence if the sentence is at least 3 years, but less than 5 years.
 - Eight days for each month of the sentence if the sentence is at least 5 years but less than 10 years.
 - Ten days for each month of the sentence, if the sentence is 10 years or more. All sentence computations will follow DODI 1325.7M except for inmates adjudged before 1 January 2005. Sentences are computed by according to AR 633-30 and DOD 1325.7M.
- **Earned-time abatement.** Facility commanders can grant earned time as an additional incentive to prisoners who demonstrate excellence in work, educational, and or vocational training pursuits. The facility commander designates jobs in writing for which earned time is granted. Facility commanders require work supervisors to report the prisoner's conduct and work performance at least quarterly, and these work evaluations are used to award earned time. Prisoners enrolled in the earned-time program who receive poor evaluations or disciplinary measures that prohibit them from working are not awarded earned time. (See AR 190-47 for earned-time computation.)

VOCATIONAL TRAINING AND EDUCATION

8-18. Organized vocational training and academic classes will be conducted at Army Corrections System facilities when resources are available. Facility commanders should ensure that vocational training programs are integrated with academic programs and are relevant to the vocational needs of prisoners and to employment opportunities in the community, such as—

- **Vocational training.** Vocational training includes the training in trades, industry, business, and other vocations designed to assist prisoners in pursuing employment in private industry upon release. Vocational training and supporting academic instruction may include—
 - Practical work or vocational training projects under the supervision of a trained instructor or a skilled employee of the DOD. The work/training is organized and operated per applicable educational, military, or industrial standards and should be designed as self-sustaining. Such programs may provide for practical and classroom instruction.

- Maintenance details using skilled supervision and modern equipment available on the installation. Detailed training objectives are developed when a maintenance detail is as designated as a vocational training position. Related military or civilian correspondence course participation to supplement the work experience will be permitted.
- Individual vocational/academic counseling closely correlated with work placement opportunities upon the prisoner's release.
- **Academic vocational programs.** Prisoners may be permitted to pursue other nonmilitary correspondence courses at no expense to the Army. They may also be required to participate in formal, vocational training classes and correspondence courses at Army expense.
- **Apprenticeship Training Program.** The Apprenticeship Training Program (in coordination with the Department of Labor, Bureau of Apprenticeship and Training, and craft labor unions) may be established at Army Corrections System facilities.
- **Textbook and teaching aids.** When applicable, Army publications may be used. When appropriate and available, textbooks, job instruction sheets, industry standard textbooks, and teaching aids/devices may be furnished by the Army Corrections System facility.
- **Vocational training funds.** Appropriated funds may be used to pay for vocational training programs per AR 190-47 and may be supplemented with the use of nonappropriated funds per suitable nonappropriated fund regulations.

ACADEMIC INSTRUCTION

8-19. Another element of the correctional program involves providing instruction to U.S. military prisoners. Considerations involved with instruction include—

- **Program establishment.** Facility commanders establish academic programs which ensure that eligible prisoners are afforded the opportunity to participate. Upon availability of resources, community facilities, and local businesses, the program may contain the following:
 - Educational philosophy and goals.
 - Communication skills.
 - General education.
 - Basic academic skills.
 - General education diploma preparation.
 - Special education.
 - Vocational education.
 - Postsecondary education.
 - Other educational programs as dictated by the needs of the prison population.
- **Educational counseling.** As an integral part of the initial assignment procedure, each prisoner is counseled with respect to educational opportunities/needs. A definitive education and career plan to meet personal needs is established, and every practicable opportunity to complete it is provided.
- **Prisoner instructors.** The facility commander may approve the use of qualified prisoner instructors when qualified military or civilian personnel are not available. In addition to full-time personnel, part-time services of qualified instructors recruited from the surrounding community, such as high school teachers and college professors, are used when possible.
- **Testing.** Educational testing, diagnosis, and appraisal of factual information concerning the prisoners' academic and vocational education is conducted as an essential part of planning academic and vocational training programs during in-processing, including the following:
 - Prisoners are given educational achievement tests and tests to determine their educational level and mechanical aptitudes. In addition, a brief presentation of educational and vocational opportunities is given to each new prisoner. On the basis of resources available, a training program that is suited for each particular prisoner is recommended.

- Physical handicaps discovered as a result of medical examinations and their bearing on training are considered in formulating a prisoner's academic training program.
- The proposed training recommendations are included in the prisoner's admission summary and brief statements on testing and interviewing results.
- **Academic files.** The facility maintains an academic file on each prisoner, to include achievement test results, interview sheets, and school records.

WELFARE ACTIVITIES

8-20. Commanders establish welfare activities as part of confinement this as follows:

- Facility commanders establish policies and procedures and implement a comprehensive recreational program that includes leisure activities and outdoor exercise. The program will describe policies and procedures for the selection, training, and use of inmates as recreation program assistants.
- Welfare activities include provisions for reading material and physical recreation facilities. Prisoners are authorized to retain the following welfare items in their possession, with reasonable restrictions as to quantities and sizes as directed by the facility commander:
 - Bibles, prayer books, and religious pamphlets and scriptures appropriate to the prisoner's faith as recognized by the Office of the Chief of Chaplains.
 - Textbooks and appropriate military and vocational training manuals.
 - Books and magazines approved by the facility commander or a designee.
 - Personal letters and photographs.
 - Official and personal documents.
 - Writing materials. Facility commanders may, for good cause, designate the type of writing instrument, such as a ballpoint pen or pencil.
 - Library services, to include a reference section, MCM, and other legal resources.
 - Prisoner recreation programs may include sporting events, hobby shops, radio, television, indoor games, motion pictures, videocassettes, creative writing, painting, and other appropriate activities. (See AR 215-1.)
- Free admission motion picture or videocassette service may be provided to Army confinement and correctional facilities.
- American Red Cross assistance is requested from the American Red Cross representative serving the host installation.
- Religious services are provided to prisoners. Prisoners are allowed to worship according to their faith, subject to the security and safety of their confinement as highlighted in AR 190-47 and AR 600-20.

SECTION II – DETAINEES

PROGRAMS

8-21. The strategic importance of operations in fixed I/R facilities should not be underestimated. Information operations, continued support of multinational allies, U.S. popular opinion, and international scrutiny are influenced by events and processes or procedures that occur within fixed I/R facilities. The nature of field detention generally means that actual rehabilitation programs will not be conducted at levels below the TIF. Rehabilitation programs within fixed facilities and the associated internment process have strategic and international importance with long-term effects that influence policy and procedural decisions.

8-22. The complexity of TIF operations associated with long-term rehabilitation begins with the identification and assessment of who is being detained within the fixed I/R facilities. This assessment starts at the POC by conventional and special operations forces and continues throughout the internment of those detained, up to and through the reconciliation process. The former doctrinal segregation of officers, enlisted, civilians, and females now extends to ethnic groups, tribes, behaviors, religious sects, juveniles,

and other categories. An inaccurate assessment can have immediate and significant effects that could result in injury or death to detainees, contribute to insurgency ideals, and cause major custody and control problems within the fixed I/R facilities.

8-23. The numbers and categories of detainees have increased the complexity of operations in fixed I/R facilities and the design of and required services to support and sustain the facilities. Fixed I/R facility complexity mirrors major civilian prison operations and must be resourced and treated as such to address many of the custody, control, and sustainment challenges associated with operating fixed I/R facilities.

8-24. Throughout the custody process, the methods used to identify and segregate insurgents and those susceptible to their recruiting efforts are important. Interrogators and investigators should realize the operational advantages that can be gained through reengaging detainees and continuously assessing the information available within the fixed I/R facility. The development of enduring processes that exploit information gleaned from the population inside the facility is critical to the safety and security of the facility cadre and detainees, and can provide information actionable intelligence to support ongoing operations outside the facility. This source of intelligence can be especially relevant in support of a counterinsurgency effort.

8-25. U.S. forces conducting detention operations must balance several requirements for fair and humane treatment with security and protection efforts within the facility. Cultural considerations may further complicate the conduct of operations and how personnel interact with detainees. The following factors are considered when implementing detention policy:

- **Consistency.** Punishments and rewards should be meted out equitably. If a detainee receives a punishment for a certain offense, every similar offender should receive the same punishment.
- **Discipline.** Strict discipline is required of detainees and detention personnel. Detainees will exploit contradictions, discrepancies, and double standards if they believe that detention personnel are not held to the standards established for them.
- **Respect and dignity.** Soldiers and guards should ensure that every aspect of their job is done with the preservation of dignity in mind.
 - **Autonomy.** Decisions that do not have to be made by detention staff should be delegated to a detainee. These situations will be severely limited in a detention setting. However, when a detainee is anticipating the loss of all freedoms, token or fabricated opportunities for empowerment will go a long way in maintaining a level of dignity and self worth that is critical to maintaining order and, ultimately, rehabilitating detainees.
 - **Religious tolerance.** Religious services are provided to detainees. They are allowed to worship according to their faith, subject to the security and safety of their confinement.
- **Transparency.**
 - **Manage expectations.** Detainees should know exactly what is expected of them at all times, and know what is expected of the detention personnel.
 - **Formal charges.** It is imperative that apprehended detainees are provided a degree of transparency regarding the purpose for their apprehension.
 - **Promises.** Do not make promises that cannot be kept. Do not break promises that have been made. Negotiate alternate courses if the position requires a modification to a previous commitment.
- **Visitation.** Detainee visitation provides an excellent opportunity to propagate a favorable message about U.S. and multinational forces. These measures mitigate the anxiety surrounding a detainee's detention, and their vast social networks will hear of the care afforded to them.

8-26. Beyond these general guidelines, a number of specific policies or approaches to the detention process will increase opportunities to exploit relevant cultural factors. The detention facilities should take advantage of the fact that they have a population of mostly military-aged men in a controlled environment. This is an excellent opportunity to address and reverse some of the factors that contribute to criminal behavior, antisocial activity, or support to indigenous insurgency efforts within or outside the facility.

8-27. Detention facility commanders and detention cadre should ensure that detainee schedules are rigid, predictable, and filled with educational, life skills, and vocational instruction. Account for time for

interrogations (when required), counseling, and recreation. Typically, schedules should not allow for naps or extended periods of idleness. Individuals thrive on having a purpose, status, mission, relevance, dignity, importance, and honor and on being honored. It is imperative that the source of the fulfillment of those needs transition, at least in part, to education and occupation. There are several areas to consider in executing a holistic rehabilitation program, to include—

- **Education, training, and self-development.**
 - **Evaluation and assessment.** Factors such as detainee literacy, education, geographical origin, vocational skills, professional skills, military experience, construction skills, and management experience should be considered.
 - **Academic education.** After separating detainees by literacy, detainees can receive instruction on a broad range of subjects, with a curriculum coordinated with the HN. Beyond basic education for the younger or poorly educated detainees, the curriculum may also include HN politics, HN constitution, and the structure of the HN government. Other worthwhile periods of instruction may include money management, job applications, basic computer skills, basic communication skills, hygiene, first aid, reporting crimes and suspicious activity reporting, and community familiarization and awareness.
 - **Vocational, occupational, and professional training.** As a result of the initial assessment and evaluation, the detainee may be enrolled in a vocational track. The track should mirror the local industry to ensure that skills developed in detention are relevant upon detainee release. The detention facility commander may approve the use of local community or skilled detainees to teach these skills.
 - **Religious discussion.** Religious discussion programs may be made available upon approval of the detention facility commander.
- **Teaming.** Detainees may break up into small groups or teams. This will allow detainees the opportunity for social development, integration, and exposure to the perspectives of others. These teams should be a cross-sectarian mix; represent the spectrum of ages, experience, and education; and be balanced to meet the needs of the detention system and contribute to order and civility. The team will be the detention facility's unit and do everything together. The team leader may serve as the liaison with detention staff and convey fellow detainees' sentiments.
- **Recreation.** Detention facility commanders establish policies and procedures and implement a comprehensive recreational program that includes leisure activities and outdoor exercise. One example of this may be organized soccer matches to allow physical activity and team building for detainees.
- **Leadership visibility.** Senior leader should make frequent appearances. The display of concern for order and control will resonate among the facility because detainees will know that order is being maintained at the highest levels and that the guards are being supervised appropriately.
- **Detention support personnel.** Aside from traditional functions that need to be performed in a detention setting, several support functions should be considered to facilitate the successful functioning of the system and to drastically improve the detention system's image and ability to gather useful information. These additional support positions (to include counselors, detainee advocates/liaisons, and reintegration facilitators) may be provided by HN personnel.
- **Information operations.** Robust information operations, to include police engagement strategies, may be implemented within, and associated with, the detention system. These operations should target the detainees, detention staff, local community, and society at large.
- **Sponsorship program.** The system of vouching for others' credibility and character is a long-established system in most societies. These unofficial contracts may not be legally binding, but they do have some significance to the parties. Sponsors may be one of the justice system's proxy parole officers, monitoring the released detainee and ensuring that he or she is honoring the terms of release.
- **Community centers.** If programs similar to those outlined above are implemented in the HN penal system, it may be necessary to establish community centers that offer the same services. These centers will provide the released detainee a venue where he or she can continue the education and training he or she was receiving. Community centers will also allow services

(such as literacy, adult education, life skills, vocational skills, and computer skills) to everyone in the community, rather than being limited to just to those who were incarcerated.

- **Separation of detention from imprisonment.** The ultimate objective of stability operations is the transition of operations to HN control under the rule of law. As this transition matures, the population within detention facilities will change from detainees who are held as combatants, CIs, or RP to facilities that hold those who are truly criminals. Every effort must be made to maintain the physical separation of detainees (which may be detained for other than criminal activity), accused criminals who have not been tried and convicted in the courts, and criminals who have been sentenced subsequent to court proceedings within the government legal system.

8-28. Circumstances may warrant the preclusion or compromise of some of the above considerations; however, the above guidelines will facilitate positive perceptions, cooperation, and assistance.

REHABILITATION PROGRAMS

8-29. Rehabilitation programs are not mandatory, but they should be encouraged for detainees who are assessed to be appropriate candidates for rehabilitation. Rehabilitation programs should be constructed based on the specific needs of detainees and the environment into which they will be released. In some OEs the detainees may be almost totally illiterate, requiring extensive baseline academic training to increase literacy. Other populations may be very literate, but live within environments that are economically challenged, requiring vocational training or education to develop skills that can result in economic prosperity for individuals and the HN. There are any number of environmental considerations and combinations of factors that must be weighed when developing a relevant rehabilitation program.

EVALUATION AND ASSESSMENT

8-30. Throughout capture, processing, and orientation to the detention system, each detainee should be carefully evaluated. This evaluation is used to place the detainee appropriately within specific rehabilitation programs. Factors such as literacy, education, geographical origin, vocational skills, professional skills, military experience, construction skills, and management experience are considered. Religious affiliation should only be used in the context of appropriate placement. Detention and prison environments may serve as optimal arenas to remove sectarian biases and the pervasive sense of sect-based quotas. The assessment of detainees' backgrounds allows the detention staff to use resources properly, mitigating the burden on the detention staff and state.

8-31. Some detained personnel, specifically during stability operations, may be detained for criminal activity that is deemed a threat to U.S. assets or to HN or multinational partners. Though the crimes they are alleged to have committed should not be a consideration in their treatment, the assessment of these factors may help to strategize the appropriate placement of detainees. A detainee may be a combatant who meets all criteria under the Geneva Conventions as an EPW and may benefit from some level of job training that is consistent with rehabilitation programs. While EPWs may not require rehabilitation in the strictest sense, training them with a skill that they can apply upon release may provide them with nonmilitary-related opportunities that can contribute to their economies and support their families upon release. Further, these programs keep them actively engaged in a constructive activity making them less likely to cause disruptions within the facility. All of these things must be considered when evaluating and assessing requirements.

VOCATIONAL TRAINING AND EDUCATION

8-32. While a strong liberal arts education may be considered the foundation of a rehabilitation process, a vocational education is generally the core of a successful rehabilitation process. Vocational training potentially provides the skills for immediate employment and economic viability for a detainee upon reintegration into the population. After initial assessment and evaluation, detainees may be enrolled in a vocational track. These tracks should mirror the local industry so that the skills developed in detention are relevant upon release. The initial evaluation and assessment considers the detainee's prior work history, occupational interests, occupational aptitudes, and employment opportunities offered in his or her community. It also provides for occupations that are personally meaningful to the detainee, while

supporting the detainee's academic and resocialization needs. Following the initial evaluation and assessment, the detention staff compiles a list of tracks that are consistent with the detainee's abilities and interests. The detainee is given the opportunity to choose his/her preference from that list. This process is important to the overall rehabilitation strategy because the opportunity to make choices provides an opportunity for detainees to exercise a level of autonomy. Introducing the ability to make choices regarding their future allows for the preservation of dignity and control in a relatively powerless environment.

8-33. Local businesses are typically consulted to determine what skills are in demand, and vetted members of the local community may be used to teach these skills at the detention facility. This allows the detainees to learn a skill as it is practiced in the community and also establishes points of contact within the industry. The proactive enlistment of community involvement is very beneficial to the detainee's reintegration, allowing acceptance and reintegration to begin before the detainee is released. Strong community involvement and support also provides potential employers with a pool of skilled laborers in which they have established a relationship. Detainees may possess skills of their own that can be exploited to instruct other detainees. With the wise use of resources and the incorporation of vocational training in the rehabilitation system, detainees can become some of the most useful and potentially productive members of society. Vocational and professional training may be made available for—

- Management.
- Fireman.
- Entrepreneurship.
- Medical specialties.
- Construction specialties.

8-34. Coordination with the local HN business community can provide opportunities for work programs in which the detainees can gain hands-on experience in their chosen vocation. These opportunities depend on the local economic environment and the economy's ability to absorb the workforce. These work programs must be carefully controlled, and participants (detainee and sponsoring business) must be evaluated for security risks.

8-35. Transition programs may be integrated for detainees who have received release documentation and are awaiting reintegration by the appropriate HN authority. This provides for the continuing education of the detainee to reinforce structure and self-improvement, increasing the probability for success when they are integrated back into society.

ACADEMIC INSTRUCTION

8-36. A facility may require the implementation of educational programs that are geared to benefit detainees—coupled with other rehabilitation efforts outlined in the following paragraphs. The detention facility is not only dedicated to sustaining good order and discipline, but also attempts to better individual detainees in preparing for future reintegration into society.

8-37. The TIF reconciliation center is responsible for ensuring that each program of instruction has the potential to provide a substantial impact on detainees participating in the programs. Rehabilitation programs are self-improvement programs where each willing detainee has the opportunity to better himself or herself and achieve program outcomes. These programs are critical for reintegration into the population. Self-improvement programs (literacy, life skills) offered by the TIF reconciliation center and coupled with additional programs (vocational, information operations, economic programs) that support the civilian population and economy can achieve a substantial level of success.

8-38. Educational programs developed and offered by the TIF reconciliation center should be based on the literacy rate of detainees within the facility. Illiterate detainees are separated from those who are literate, and the curriculum is devised accordingly. The educational programs supporting higher learning skills should be approved by the HN and monitored for proper curriculum development that is consistent with, at a minimum, HN educational standards. These services may need to be designed to teach a person who had little or no educational background before internment.

8-39. The lack of basic reading, writing, and math skills may be a major contributing factor to why a high number of illiterate males participate in combatant or illegal activities. The diminished opportunity to

obtain profitable employment needed to support families may cause some to support criminal or insurgent elements for employment. The lack of education can be a major contributor, causing moderate males to turn to combatant, criminal, or insurgent activities for monetary reasons, even though they do not believe in or personally support the activities or cause. Moderate detainees who participated in combatant, criminal, or insurgent acts because of little or no opportunity to provide for their families, may be discouraged from rejoining combat, criminal, or insurgent organizations through education programs and the subsequent opportunities that education provides.

8-40. The TIF reconciliation center may focus on elementary education if detainees possess only rudimentary education skills. Detainees attending these classes may have no formal education experiences and may be illiterate. Illiteracy can lead to desperation that fuels adverse motivations in otherwise moderate detainees. Detainees participating in rehabilitation programs may be scheduled to attend school for a predetermined period and be tested at the end of the period to measure their comprehension. If a detainee meets program standards, that individual receives credit for the program; if the detainee does not pass program standards (as set by the TIF reconciliation center and HN), the individual does not receive credit. The educational programs may be taught by HN teachers who are employed by the TIF reconciliation center services. Some program teachers may be detainees or RP with specific skills. Teachers develop educational programs based on detainee constraints, time available, and security requirements.

8-41. Religious discussion groups may also be offered to detainees as a program to educate them on specific aspects of their religion. The program should be taught by vetted religious leaders of the same religious affiliation as the detainees. The program educates detainees on the nationally accepted teachings of their religion as viewed by the HN society. During the program, detainees are brought together with religious leaders and scholars to focus on major teaching points of dogma. The program may be valuable in curbing extreme fanaticism that may be a catalyst for violence within the detainees' world view.

8-42. A liberal arts education has been described as "the foundation of the rehabilitation process." A curriculum such as politics, HN constitution, and the structure of the HN government provides more fluency in discussing these topics, and detainees will better appreciate their situation and how they can peacefully contribute to its success. Other worthwhile periods of instruction may include managing money, job applications, basic computer skills, basic communication skills, hygiene, first aid, crime and suspicious activity reporting, and community familiarization and awareness.

RELIGIOUS DISCUSSION GROUPS

8-43. The detention facility commander may approve religious discussion groups within the facility. The goal for religious groups is to provide religious support to detainees and moderate extremists within the facility. This is above and beyond the standard clerical support that is required and provided in the course of normal detention operations. Clerical leaders who are chosen to participate must be carefully vetted and are typically selected from moderate elements of their respective religions. Religious discussion is never forced on a detainee; participation in this program is voluntary.

8-44. Extremists participating in religious discussion groups may be tempered by the more moderate philosophy and reinforced by socialization with other more moderate detainees. It is also possible that religious extremists may reject a moderate interpretation of their religion and detract from efforts to present a moderate approach. Many extremists may not participate, fearing that the facility-sanctioned advocate is a cooperative spiritual leader. Detention facility commanders must allow autonomy, within established security requirements, for religious leaders and instructors. The only way that moderate leaders retain credibility is by operating on their own—forced sessions of "religious reeducation" only discredit a religious leader to those who are receptive and have little impact on those who are inherently beyond reconciliation. Detainees may also use personal time to engage in worship or religious study on their own. The detention system may wish to implement instruction in "social intervention" based on HN principles, rather than straight doctrinal dogma.

TEAMING

8-45. Socialization is an important component of prison populations. The detention system is composed of teams to mitigate the potential for socialization and indoctrination that is counter to U.S. and HN interests

and to shape positive socialization and influence. This allows detainee opportunities for social development, integration, and exposure to the perspectives of others within a group that is populated in a manner which reduces the likelihood of disruptive, criminal, or antisocial behavior. Following initial evaluation and assessment, detainees are placed on an existing team. Just as individuals are segregated upon apprehension for security and information-gathering purposes, the detention population is similarly segregated and recombined in elements that facilitate security and information gathering and shaping of the detainee social network.

8-46. A team established within the detention facility conducts all activities as a group. The team leader serves as the liaison with detention staff and conveys fellow detainees' sentiments. Teams aid in converting detention into a rehabilitative environment, rather than one that is punitive or idle. Teams do not eliminate extremism or recidivism, nor do they create jobs. However, they may diminish the prevalence or need to engage in profitable criminal behavior because released detainees are better equipped to function appropriately in society.

RECREATION

8-47. Many military police express support for physically exhausting activity in detention as a positive outlet for energy that may otherwise be used for counterproductive purposes. Sports clubs may be organized within the facility for this purpose. Time and space are set aside to accommodate detainees' physical exercise. This also contributes to the socialization of the detention population. Teams are cross-sectarian, and military police foster the right messages within this context.

LEADERSHIP VISIBILITY

8-48. Detainees may have a heightened respect for high-ranking officials. Order within a facility is likely to increase with increased leadership visibility. Therefore, senior leadership should make frequent appearances throughout the facility. This display of concern for order and control resonates among the facility as the detainees know that order is being maintained at the highest level and that guards are being supervised appropriately. However, leaders should ensure that guard force duties and responsibilities are not undermined. Leadership needs no specific reason to make rounds and conduct random inspections. Detainees typically feel secure from abuse (from guards and other detainees) and may be discouraged from inciting unrest. When senior leadership enforces even the most trivial infraction among the detention staff, it sends a clear message to the detention population that order is to be maintained in the facility.

DETENTION SUPPORT PERSONNEL

8-49. Several support functions should be considered to facilitate the ability to gather useful information to further the rehabilitation process, and identify rehabilitation failures or setbacks. This support may include behavioral health personnel, detainee advocates/liaisons, and reintegration facilitators.

Behavioral Health Personnel

8-50. Behavioral health services will be provided to detainees, based on the availability of medical resources and patient workload. Resources to provide this care may be task-organized and may include inpatient and outpatient care. Health care personnel providing behavioral health services to detainees may include a psychiatrist, psychologist, social worker, behavioral health nurse, occupational therapist, and behavioral health specialist.

8-51. All detainees will receive a behavioral health screen when in-processing and before distribution into the general population. A translator will be used to translate between the screener and the detainee. The behavioral health screen will be conducted by a behavioral health team member. Each detainee will be screened individually to maximize privacy. The behavioral health screen will include whether the detainee has a present suicide ideation, the history of suicidal behavior, the history of (or current) psychotropic medication use, current behavioral health complaints, the history of behavioral health treatment, and/or the history of treatment for substance abuse. During the behavioral health screen, each detainee will be observed for general appearance and behavior; evidence of abuse and/or trauma; and current symptoms of

psychosis, depression, anxiety, and/or aggression. After screening, each detainee will be recommended for placement into the general population, placement into the general population with appropriate referral to behavioral health, or referral to behavioral health for an emergency assessment prior to placement into the general population. The screening will begin with an introduction and explanation of the nature and purpose of the screen. Each question will be asked by the screener and translated by the translator. Under no circumstance will a translator conduct the screen. Behavioral health screening forms will not be presigned, and detainees will not be screened in groups. The original completed screen will be placed in the detainee's individual medical record.

Detainee Advocates/Liaisons

8-52. Detainee advocates may be used by detention facility commanders to serve as liaisons between detainees and facility leaders. The detainee advocates serve as sympathizers and mediators in a facility. Many of these positions may be filled by vetted HN personnel. The difference in rehabilitative effect by having an indigenous person perform this function, rather than even the most concerned U.S. leader, can be profound. Their primary responsibility is addressing detainees' concerns and finding resolutions that are mutually acceptable to detainees and facility leadership. Advocates address all detainee concerns, regardless of how unfounded, baseless, or improbable the allegation. The advocates liaise with team leaders and are responsible for investigating claims and discussing reasonable solutions with facility leadership. This advocate-team leader channel should be strictly followed. Having concerns and complaints addressed also gives the detainees another degree of autonomy. Advocates have no decisionmaking authority, only the capacity to pass on decisions that have been made by facility leaders. Detainees may view sympathetic decisionmakers as targets of pressure and manipulation. The role of an advocate provides a buffer for that very reason. Detainees are made aware of the decisionmaking limitations of the advocates to limit the extent to which they are manipulated.

8-53. Advocates are also responsible for facilitating individual religious worship (such as providing prayer rugs, Qur'ans, Bibles, or other religious literature and accoutrements). Another function of the advocates includes liaising with detainee families to ensure that they have the most accurate and current information regarding their loved one. They are also involved in scheduling and managing visitation. Recently released or soon-to-be released detainees are prime candidates for this intermediary role.

Reintegration Facilitators

8-54. Not all detainees commit crimes for motives relating to economic or social desperation; however, these may be important underlying motivations for a significant number of them. For these detainees, no amount of exposure to military police, broadening of perspective, or increased understanding is going to address the fundamental need that was the impetus for the crime. The detention system must reach beyond the detention facility as halfway houses, convict-to-work programs, and parole officers do in the American justice system. Much like a U.S. parole officer, a reintegration facilitator coordinates release and reintegration functions for detainees. These facilitators are typically vetted HN personnel who are employed to act in this capacity.

8-55. Reintegration facilitators establish a relationship with the detainee as release approaches. They review the detainee's file and make appropriate recommendations, referrals, and placements within the community that take advantage of education and skills acquired in detention. Reintegration facilitators are responsible for networking with organizations and persons, to include—

- Local business.
- Vocational schools.
- Colleges.
- Law enforcement offices.
- Prison and detention facilities (for released detainees who could fill detainee support positions within detention/prison facilities).
- Medical community.
- Local contractors.

8-56. Facilitators work with the preceding organizations and persons to make the most appropriate placement. They should make periodic contact with released detainees to track progress, keep them on the radar, and offer further assistance. They may also be responsible for meeting with detainee families before release to advise them on how best to assist with reintegration and what, if anything, is expected of released detainee from a legal and moral standpoint.

INFORMATION OPERATIONS

8-57. Robust information operations, to include military police engagement strategies, are implemented within, and associated with, rehabilitation efforts and detention operations in general. Information operations within a facility may be conducted to stress that the detainee's society is suffering while its youth, talent, and experience have chosen incarceration over rebuilding the HN civilization. Counselors are effective conduits for this kind of information within the facility. All detention cadre should be used to gather information for effective information operations within the facility. Information operations outside the facility can be conducted to publicize successes and benefits of specific programs. These engagement strategies target detainees, the detention staff, the local community, and society at large. This can be accomplished through personal interaction between detention facility leadership and local representative and leadership, articles in local newspapers, and broadcasts via radio or television. Examples of engagement topics include—

- Success stories from effective community involvement.
- Detainee completion of instruction programs and vocational training, to include formal completion or graduation ceremonies.
- Holiday releases of detainees.

SPONSORSHIP PROGRAM

8-58. Sponsorship programs can be framed in such a way as to hold sponsors accountable at some level. Reasonable consequences may be attached to the violation of sponsorship terms by the sponsor (loss of government contracts or public association with the offender). Sponsors can be used as one of the justice system's proxy parole officers, monitoring a released detainee and ensuring that he or she is honoring the terms of release. A recognized sponsorship arrangement can hold all involved accountable and give the justice system added justification for actions it takes against the detainee in case of recidivist conduct.

COMMUNITY CENTERS

8-59. Community centers can play a major part in community development and democracy as seen through individuals organizing themselves into neighborhood groups and attending to people's needs, desires, and aspirations. Community centers are an educational, social, and recreational community resource. There may also be community centers that serve a specific purpose for the whole community, such as an arts center.

8-60. Community centers may be squatted, or rented buildings, that have been made into organized centers for community activities; support networks; institutional initiatives free kitchens, (free shops, public computer labs, graffiti murals); free housing for activists and travelers; recreation; public meeting rooms; legal collectives; or spaces for dances, performances, and art exhibitions. Centers in a more established setting may be directly connected with a library, swimming pool, gymnasium, or other public facility.

8-61. Community centers have various relationships with the state and governmental institutions. Within the history of a given institution, they may move from a quasilegal or illegal existence to a more regularized situation.

8-62. The detention system provides an ideal venue for rehabilitative measures. A converted audience, assimilated into a structured regimen allows society an otherwise elusive opportunity to infuse employable skills and education into a subset of the population that has a great need for attention and validation. Regardless of guilt or innocence, conviction or release, detainees come away from detention or imprisonment better able to contribute positively to their community. American perception is positively altered, and the desire to attack multinational forces is diminished. Detainees gain valuable knowledge and

skills that motivate them to assist military forces once released. Their understanding and appreciation of the current situation is improved, and they are, therefore, better able to secure their neighborhoods and communities.

Chapter 9

Parole, Transfer, or Release of U.S. Military Prisoners and Detainees

DOD policy requires that I/R programs be operated by the military in a manner that strives to achieve uniformity, effectiveness, and efficiency in the administration of I/R functions. The release of U.S. military prisoners is conducted to foster the safe and appropriate release of military offenders under such terms and conditions that are consistent with the needs of society, the rights of victims, and the rehabilitation of the prisoner. Detainee release is the process of returning a detainee to his country of birth or citizenship or to the POC. A detainee who is not sick and wounded is released at the end of hostilities or when as directed by the Office of the Secretary of Defense. Sick and wounded detainees will not be released against their will during hostilities. The release process is critical to ensuring a successful transition into society.

RELEASE OF U.S. MILITARY PRISONERS

9-1. The release of U.S. military prisoners typically involves the completion of a sentence as a result of clemency, parole, or mandatory supervised release. This chapter focuses on release as a function of a parole or mandatory supervised release.

POLICIES AND PROCEDURES

9-2. The objective of the Army Corrections System is to prepare military prisoners for release, whether they return to duty or civilian status, with the prospect of becoming productive Soldiers/citizens by conforming to military or civilian environments. (See AR 190-47.) The Army Corrections System provides the environment, opportunities, and assistance to enhance living skills among posttrial prisoners in preparation for their release from confinement. Military prisoners will be released from confinement under the conditions most likely to ensure that their earliest assumption of responsibilities as productive law-abiding citizens. In rare cases, selected Army prisoners may return to duty.

9-3. Policy and procedural guidance for parole and the mandatory supervised release of U.S. Army prisoners is contained in AR 15-130. Army Corrections System commanders will convene disposition boards to evaluate and make recommendations regarding prisoners confined in Army facilities, per criteria established by the Army Clemency and Parole Board. Disposition boards will refer to the considerations in AR 15-130 when evaluating Army Corrections System prisoners for parole consideration.

JURISDICTION

9-4. A prisoner on parole or mandatory supervised release will remain under the legal supervision and control of the releasing facility and a local U.S. probation officer assigned by the Probation Division of the U.S. Courts, until the expiration of the full term or aggregate terms of the sentence, without credit for abatement. The U.S. Parole Commission, Department of Justice, has jurisdiction over Army prisoners confined in federal penal and correctional institutions in matters concerning parole and mandatory supervised release.

9-5. Prisoners from an Army Corrections System facility who have parole or mandatory supervised release approved will remain under the releasing facility's control at the time of release on parole or mandatory supervised release unless otherwise directed. The facility commander or designee will electronically notify the Army Clemency and Parole Board in advance, but no later than the day before the date of release on parole or mandatory supervised release. (See AR 15-130.)

PRELIMINARY PAROLE/MANDATORY SUPERVISED RELEASE CONSIDERATIONS

9-6. Each eligible prisoner will execute a DD Form 2715-3 (*Inmate Restoration/Return to Duty, Clemency, and Parole Statement*) or equivalent automated form in duplicate, indicating whether parole is desired. The original form will be forwarded to the Army Clemency and Parole Board, and a duplicate copy retained in the prisoner's correctional treatment file. If a prisoner is unable or refuses to sign the parole statement, it will be forwarded with an appropriate explanation.

9-7. The only prisoners eligible for mandatory supervised release are those with an approved finding of guilt for an offense that occurred on or after 16 August 2001, who are eligible for parole, but are not paroled. A prisoner's willful failure to prepare an acceptable mandatory supervised release plan may result in a Discipline and Adjustment Board for the loss of good conduct time and earned time. The departure of the prisoner from the correctional facility constitutes acceptance of the terms and conditions of mandatory supervised release. If the prisoner refuses to depart the correctional facility, the prisoner may be charged with failure to follow an order or dereliction of duty. (See AR 15-130.)

9-8. For prisoners who have an approved finding of guilt for an offense that occurred on or after 17 October 2004, the award of good conduct time and earned time is a condition of the prisoner submitting an acceptable release plan and fully cooperating in all other respects with mandatory supervised release.

9-9. Each prisoner desiring parole will complete all sections of DD Form 2715-3 and submit it to the commander or designated representative before local parole consideration and in accordance with local SOPs. The prisoner will be provided necessary assistance in developing a satisfactory, tentative parole plan and will be encouraged to take the initiative in developing a parole plan. The prisoner will agree, in writing, to abide by that plan. The U.S. probation officer will not be requested to establish or verify any element of the prisoner's tentative parole plan before parole approval by the Army Clemency and Parole Board.

9-10. Prisoners who do not desire parole when eligible or prisoners whose previous requests for parole were disapproved by the Army Clemency and Parole Board may request consideration before their next annual eligibility date if sufficient justification exists for an interim consideration of their cases as determined by the Army Corrections System facility commander.

DISPOSITION BOARD ACTION

9-11. Normally, requests for parole will be considered by the disposition board and forwarded to the Army Clemency and Parole Board to arrive no later than 30 days before the prisoner's parole eligibility date. Requests may be considered up to 120 days in advance of the eligibility date when such action permits concurrent consideration of sentence remission or restoration to duty. Requests for parole will be accompanied by documentation described in AR 15-130, to include a victim impact statement if appropriate.

9-12. The disposition board will consider each parole applicant on an individual basis in consonance with the policies and objectives of parole as specified in AR 15-130. The board's recommendations for or against parole will include reasons for their recommendation.

9-13. Before convening the disposition board, the facility commander or designated representative advises appropriate victims and witnesses of the parole consideration and informs the victims/witnesses of the address to which impact statements may be forwarded. If required, prisoners acknowledge in writing that they will comply with state violent or sexual offender reporting and registration requirements. Similarly, candidates for parole should demonstrate compliance with court-ordered dependent support or restitution to victims who have made arrangements to the courts' satisfaction.

9-14. The Army Corrections System facility commander or a designee will review the disposition board's recommendation to ensure that the policies and objectives of parole have been considered in the evaluation and recommendation. When the Army Corrections System facility commander's parole recommendation differs from that of the Disposition Board, the reasons will be stated.

DEPARTMENTAL ACTIONS

9-15. The Army Clemency and Parole Board approves or disapproves Army parole applications submitted to that board, on a DA Form 4459 (*Parole Action Record*) or equivalent automated form/letter to record its determinations. Departmental actions also include—

- Announcing parole, which includes providing authenticated copies of a DD Form 2716-1 (*Department of Defense Certificate of Parole*).
- Providing prisoners who are denied parole with written notification of the reasons that their request was denied.
- Providing DD Form 2716 (*Parole Acknowledgement Letter*) or equivalent automated form/letter to inform prisoners of their parole denial and giving them the opportunity to appeal the decision.

9-16. Release on parole is conditioned upon parole approval and the completion of a parole plan considered to be satisfactory to the U.S. probation officer. Misconduct subsequent to parole approval may delay or preclude eligibility for parole. The Army Clemency and Parole Board or the Deputy Assistant Secretary of the Army (Review Boards) may delay the scheduled parole release date or rescind parole approval in the event of a major violation of institutional rules.

APPEAL OF PAROLE DISAPPROVAL

9-17. A prisoner whose application for parole has been denied may submit an appeal through the Army Corrections System facility commander within 60 calendar days of receiving written notification of the denial. New or additional, material information that was not previously considered should be included in the appeal. The Deputy Assistant Secretary of the Army (Review Boards) or a designee will inform the prisoner of the action on the appeal. Decisions of the Deputy Assistant Secretary of the Army (Review Boards) are final.

PAROLE PLAN COMPLETION

9-18. Upon receipt of notification that parole/mandatory supervised release has been approved and before the prisoner is released, the U.S. probation officer will be requested to establish the validity of residence arrangement, employment, and other elements of the tentative parole plan. The probation officer will be promptly furnished complete information concerning the proposed parole plan, including proposed residence and employment, names and addresses of close relatives, and admission and progress summaries.

EMPLOYMENT REQUIREMENTS

9-19. Unless a waiver is granted for convincing reasons, no prisoner will be released on parole until satisfactory evidence has been furnished that the prisoner will be engaged in a reputable business or occupation or a valid educational or vocational program. Employment requirements for release on parole will be deemed to have been met when one of the following applies:

- A prospective employer has executed a letter offering employment.
- A recognized trade union or similar organization has provided documentation that, subsequent to release on parole, the prisoner will be considered a member of the organization in good standing and that, through the normal functions of the organization, the prisoner will be afforded employment rights and assistance equal to that furnished other members in good standing.
- A U.S. probation officer has validated that a job has been secured for the prisoner.
- Acceptance in a valid educational or vocational program.

9-20. In limited cases, a waiver of employment may be obtained. Every effort must be made to obtain employment before a request for waiver will be considered—to include obtaining the support of employment agencies within the area the prisoner desires to reside during parole. Before furnishing employment agencies with information from a prisoner's record, the written authorization of the prisoner will be obtained. If, after parole approval, every effort to obtain employment has been made without success, the Army Clemency and Parole Board, in coordination with the U.S. probation officer, may grant a waiver of employment. (See AR 15-130 for more information on waivers.)

CERTIFICATE OF PAROLE

9-21. On a date approved by the Army Clemency and Parole Board and specified on DD Form 2716-1, or as soon thereafter as an acceptable plan is completed, the prisoner will be released.

9-22. Prisoners are required to execute a written agreement of the specific conditions of parole. All copies of this agreement will be signed by the prisoner and witnessed by the Army Corrections System facility commander or an authorized representative. The prisoner will agree, in writing, to abide by the parole plan.

9-23. Upon approval of parole/mandatory supervised release and prior to release, the following actions will occur—

- **Medical examination.** Prisoners being released on parole will be given a medical examination per AR 40-501.
- **Identification card.** If release is implemented before the completion of appellate review, the prisoner is furnished DD Form 2A (*Active Duty Military Identification Card*), completed to show rank and an expiration date that does not exceed 1 year from issue. Family member identification cards will bear the same expiration date as that of the prisoner. The Army Corrections System facility commander will instruct the prisoner to return all identification cards through the U.S. probation officer on completion of appellate review.
- **FBI Form I-12.** The Army Corrections System commander ensures that flash notices are prepared for each prisoner released on parole and that indication is made on the form that the appropriate Army Corrections System facility is to be notified of any arrests reported to the FBI. The FBI Form I-12 (*Flash-Cancellation Notice*) provides a uniform means of filing requests with the FBI to ensure that the Army Corrections System facility commander is notified of the arrest of an individual on parole. Box 2 of the form is checked and all available information requested on the form for filing flash notices is provided. The form is forwarded directly to the U.S. Department of Justice, FBI, ATTN: Identification Division, Washington, D.C. 20537.
- **Parole limits.** The U.S. probation officer will prescribe the limits of movement based on where the prisoner resides, unless otherwise directed by the Army Clemency and Parole Board. Individuals released on parole are under the direct supervision of U.S. probation officers.
- **Gratuities.** Prisoners are furnished the following gratuities upon release on parole:
 - Prisoners in a nonpaid status are provided one pair of civilian pants, one civilian shirt, and one civilian coat (if required).
 - Transportation is provided to the parole destination per the Joint Federal Travel Regulations (JFTR) Volume 1 and 2.
 - A cash discharge gratuity is provided per DOD 7000.14-R.

CLEMENCY CONSIDERATIONS

9-24. Those under supervision (parole/mandatory supervised release) are eligible for and continue to receive clemency consideration on the established annual review date. The Army Clemency and Parole Board annually will notify the respective Army Corrections System facility and U.S. probation officer the parolee has an upcoming hearing. The U.S. probation officer sends a report of a parolee's adjustment directly to the Army Clemency and Parole Board. The Army Corrections System facility will send an electronic parole file with victim/witness information as required. (See AR 15-130.) The U.S. probation officer will furnish recommendations relative to the restoration to duty if the parolee personally submits an application for a restoration to duty.

STATUS CHANGE

9-25. If the sentence to confinement of a parolee expires before completion of appellate review, the commander will transfer the prisoner to an leave-without-pay-status. A DA Form 31 (*Request and Authority for Leave*) is required to grant excess leave.

9-26. If the parolee's sentence is ordered executed, on completion of the appellate review the commander will—

- Process separation document (DD Form 214 [*Certificate of Release or Discharge from Active Duty*]).
- Furnish the individual with instructions regarding the appellate action and request the return of identification cards that were furnished for use pending completion of the case review.

RELEASE OR TRANSFER OF DETAINEES

9-27. The transfer and release of detainees is not new to doctrine, but lessons learned have highlighted the need to focus on more than just the simple release of detainees. The term *release* has been expanded to include the preparation of detainees for reintegration in a fashion similar to that done for U.S. military prisoners and, to varying degrees of success, in our federal, state, and local prisoners in the United States. (See chapter 8 for more information on detainee rehabilitation.) The material below generally applies to transfers and all general types of release for all categories of detainees.

9-28. The detention facility commander ensures that personnel who are conducting detainee operations are trained and logistically supported to conduct transfer or release operations according to applicable laws and policies. The detention facility commander also determines air, land, and sea transportation requirements for transfer and/or release operations to the POC through the unit responsible for that operational area or AO. In addition, the detention facility commander establishes the C2 relationship between all elements involved in transfer or release (reintegration) operations. The detention facility commander ensures that notification is made of the transfer or releases of a detainee to the NDRC. Other roles and responsibilities regarding the transfer/release of detainees are as follows:

- **Detention facility commander.**
 - Develops detainee policies regarding transfer or release operations according to applicable laws and policies.
 - Coordinates with appropriate staff elements to conduct transfer and release operations.
 - Coordinates with appropriate commanders and staffs to ensure that transfer or release operations directives are disseminated throughout the joint operations area.
- **Medical officer.**
 - Ensures that policies established regarding medical requirements for the transfer and release of detainees are according to applicable laws and policies.
 - Ensures coordination of subordinate medical elements to support transfer and release operations.
- **SJA.**
 - Provides the detention facility commander with legal guidance regarding applicable laws and regulations.
 - Serves as the command liaison to the ICRC and determines authorized ICRC activities related to the transfer/release of detainees.
 - Provides technical expertise in support of required instruction and training related to the law of war.
- **Public affairs officer.**
 - Develops media policies regarding detainee operations for the detention facility commander according to applicable laws and policies.
 - Coordinates media coverage regarding detainee transfer and release operations through the chain of command.

LEGAL CONSIDERATIONS

9-29. During the conduct of hostilities, the United States and its citizens (to include U.S. armed forces) operating in support of those operations are bound by the law of war, which encompasses all international laws and applicable customary international laws and treaties and international agreements to which the United States is a party. (See DODD 2311.01E and CJCSI 5810.01B.)

9-30. Multi-Service directives such as AR 190-8, Chief of Naval Operations Instruction 3461.6, AFI 31-304, and Marine Corps Order 3461.1 address legal considerations when conducting detainee operations. In addition, DODD 2310.01E outlines legal issues regarding the reception, treatment, processing, and release of detainees. The Geneva Conventions are the primary references for conducting detainee operations.

DETAINEE CLASSIFICATION

9-31. The initial classification of a detainee may be based on unsupported statements or documentation accompanying the detainee. After a detainee is assigned to a facility, there is a continuing need for further classification. If the detainee's classification remains in doubt, a tribunal may be convened to determine the detainee's status. Reclassification may result in the release or reassignment of detainees within the facility or to other facilities.

REVIEW AND APPROVAL PROCESS

9-32. For transfer or release authority of U.S.-captured detainees, the Secretary of Defense, or his or her designee will establish criteria for the transfer or release of detainees and communicate those criteria to all commanders operating within the theater.

9-33. The designated combatant commanders will periodically assess detainees for release or transfer per applicable regulations. The JIDC commander, with the advice of the assigned interrogators, should provide recommendations to the detention facility commander for release or transfer of detainees to ensure that detainees, for whom there remains a valid basis for detention, are not released while still being exploited for HUMINT. Recommendations for transfer or release will be coordinated with other U.S. government agencies, as appropriate, and forwarded to the Secretary of Defense or his designee, for decision.

DETAINEE RELEASE OR TRANSFER TO ESTABLISHED, RECOGNIZED NATIONAL AUTHORITY, MULTINATIONAL FACILITIES, OR INTER-SERVICE AGENCIES

9-34. The permanent or temporary transfer or release of detainees from the custody of U.S. forces to the HN, other multinational forces, or any non-DOD U.S. Government entity requires the approval of the Secretary of Defense or his designee. The permanent or temporary transfer of a detainee to a foreign nation may be governed by bilateral agreements or may be based on ad hoc arrangements. However, detainees who qualify (as a matter of law) as EPWs, RP, CIs, or members of armed groups may only be transferred according to the requirements of applicable U.S. laws and policies and the law of war.

9-35. The detention facility commander, according to applicable procedures, will make the transfer or release of a detainee from a collection point or a detention facility. All proposed transfers/releases should be reviewed by the legal adviser to ensure compliance with applicable laws and policies. Unless prohibited by command policies, the immediate release of detainees may be made at the POC based on the decision of the most senior official on the ground. The decision should be based on criteria established by higher headquarters.

9-36. The temporary transfer of detainees from one facility to another is authorized to accommodate surges in the detainee population beyond capacity. Transfers will also occur to ensure that detainee treatment and conditions are adhering to applicable laws and policies. As a general rule, detainees should not be transferred closer to the harmful effects of military operations.

9-37. A detainee who is captured or detained by the U.S. military or other agencies will be turned over to the U.S. detention facility at the earliest opportunity. Inter-Service or intratheater transfers will be executed following initial classification and administrative processing.

TRANSFER BETWEEN DEPARTMENT OF DEFENSE FACILITIES

9-38. Reclassification or other situations may result in a detainee's transfer. The transferring unit will determine appropriate security measures based on the type of detainee being transferred, the mode of transportation used, and other relevant conditions.

9-39. The detention facility commander will—

- Publish a transfer order and inform the TDRC/NDRC of the movement.
- Verify the accuracy and completeness of the detainee’s personnel records and provide copies of the records (in a sealed envelope) to the guards accompanying the movement.
- Verify that detainees possess their authorized clothing and equipment.
- Account for and prepare impounded personal property for shipment with the escorting unit or by separate shipment as appropriate.
- Brief escort personnel on their duties and responsibilities (procedures for reacting to an escape, a death, other emergencies).
- Provide rations and basic needs to detainees during the movement.
- Ensure that detainees are listed by name, ISN, nationality, and physical condition (including a statement of communicable diseases if applicable).
- Prepare paperwork in English and other languages (if required) before transferring detainees.
- Ensure that detainees are given a full physical, instructions for medication, and a supply of medications.
- Ensure that appropriate health and disciplinary records accompany detainees.
- Coordinate with joint force commander’s subordinate commanders before transferring detainees.

TRANSFER OR RELEASE MISSION

9-40. For the transfer or release of detainees from within the OA to other detention facilities or for direct release of detainee into the community, the following additional requirements should be met:

- Inform detainees of their impending transfer or release so that they can notify their next of kin of their new location (when required by applicable Geneva Conventions).
- Ensure that sustainment resources are adequate (food, water).
- Ensure that detainees are listed by name, rank/status, ISN, power served, nationality, and physical condition. Attach the list to the original receipt and provide a copy to the NDRC.
- Verify collected biometric data.

9-41. For release from a long-term detention facility, the Secretary of Defense, or his or her designee will send official notification of the transfer or release. Applicable execution orders approved by the appropriate authority will delineate the responsibilities and procedures to undertake. Table 9-1 outlines the detainee release process from long-term detention.

Table 9-1. The detainee release process from long-term detention

<i>Procedures</i>	<i>Actions</i>
Control and accountability procedures	Maintain control and accountability of the detainee until he or she is transferred to the designated protecting power. Use a list to maintain accountability, and ensure that it contains (at a minimum) the following for each detainee: <ul style="list-style-type: none"> ● Name. ● Rank or status. ● ISN. ● Power served or nationality. ● Physical condition. Use a list as an official receipt of transfer. It will become a permanent record to ensure the accountability of each detainee until final release.
Detainee records	Transfer copies of the detainee’s personnel, financial, and medical records to the custody of the designated official who is receiving the detainee. Keep copies of all records.

Table 9-1. The detainee release process for long-term detention (continued)

Procedures	Actions
Detainee personal property	Transfer releasable confiscated personal property to the released or repatriated detainee. Conduct an inventory and identify discrepancies. Have the detainee sign DA Form 4137 for his or her personal items.
Completion of transfer	Forward the official receipt of transfer to the TDRC.
Transfer procedures	Ensure that the transferring TIF forwards official records and confiscated property (that cannot be released) to the TDRC for final disposition once the TDRC notifies them that the detainee transfer is complete.
Legend:	
DA	Department of the Army
TDRC	theater detainee reporting center
TIF	theater internment facility

9-42. The detention facility commander may tailor stations to meet the current situation and conditions. Some steps taken to execute the order include—

- Preparing, maintaining, and reporting the chain of custody and completion of transfer or release documentation according to current transfer or release procedures as directed by Secretary of Defense or his designee.
- Preparing individual detainees (including, at a minimum, segregating, out-briefing, medical screening, and executing conditional release statements for those detainees being released).
- Determining receipt or transfer location.
- Creating movement routes (coordinate all routes through the appropriate combatant commanders).
- Making public notification of a release and/or transfer in consultation and coordination with Office of the Secretary of Defense (due to operations security concerns).

9-43. Boards may be established to determine detainee disposition.

DIRECT RELEASE

9-44. For the direct release of a detainee back into the community, the following requirements should be met (see figure 9-1 for reintegration considerations):

- When required by applicable Geneva Conventions, the detainee is advised, in writing, of the release to enable him or her to notify his or her next of kin.
- For release from a TIF, the following requirements must be met:
 - The Secretary of Defense or his designee sends an official notification of transfer or release from the TIF, and the applicable staff agencies execute orders that will delineate the responsibilities and procedures to undertake.
 - The releasing unit prepares, maintains, and reports the chain of custody and transfer/release documentation according to current transfer and release procedures as directed.
 - The preparations for individual detainees include, at a minimum, segregation, out-briefing, medical screening, and execution of conditional release statements for those detainees being released.
 - Movement routes to the transfer location are confirmed. Coordinate all routes through the appropriate combatant commanders.
 - Public notifications of a release or transfer are made only in consultation and coordination with the Office of the Secretary of Defense due to operations security concerns.

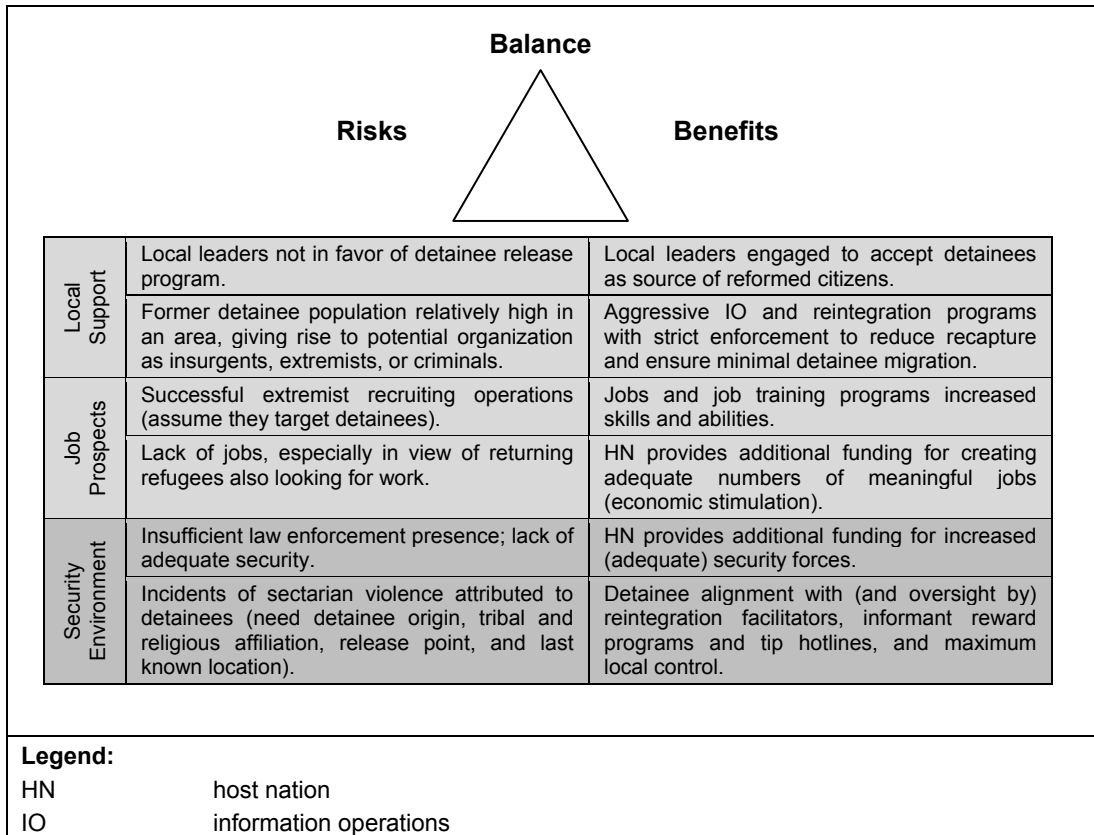

Figure 9-1. Detainee reintegration considerations

TRANSITION OF DETAINEE OPERATIONS TO CIVIL AUTHORITY PENAL SYSTEMS

9-45. Strategic-level priorities and conditions within the OE will dictate the long-term direction of theater level detainee operations. At some point, when combat actions have subsided and some predetermined level of stability is achieved, most detainees will be released, transferred, or repatriated. Detainees are traditionally released or repatriated. Various categories of interned civilians may be released once the strategic conditions which led to their internment have changed. Members of armed groups may be transferred to external facilities for strategic intelligence screening or for long-term internment. However, detainees who are suspected or convicted of committing crimes that initially resulted in their internment, or who committed serious crimes while interned, will not be released in the same manner. They may, instead, be tried as criminals in duly established military proceedings or turned over to indigenous civil courts for prosecution and adjudication. It is critical that military police plan for and position detainees for eventual release or transfer to emerging civil authority penal systems.

9-46. The permanent transfer of detainees from the custody of U.S. armed forces to HN or other multinational forces requires the approval of the Secretary of Defense or his designee. The permanent transfer of detainees to foreign national control will be governed by bilateral national agreements. Before transfer, the appropriate U.S. government representative will ensure that the receiving government is willing and able to apply the Geneva Conventions to transferred detainees and will gain assurances of humane treatment for persons convicted or pending trial for criminal activity. At the conclusion of military or stability operations, a key element that must be considered is the transfer of detainees from U.S. and/or multinational control to HN control. A myriad of factors (law enforcement, military, or judicial assets)

affect when transitions can occur with limited disruption to current operations of the U.S. and the receiving government. The following factors must be considered before releasing detainees back to the HN:

- Publish the release order and inform the detainees so that can notify their next of kin of their new location, when required by applicable Geneva Conventions.
- Verify the accuracy of the detainee's personnel and medical records and provide copies (in a sealed envelope) to the transporting unit.
- Account for and prepare impounded personal property for shipment with the escorting unit.
- Ensure that logistic resources (food and water) are adequate.
- Ensure that detainees are documented on a list by name, rank, and/or status; ISN; power served; nationality; and physical condition. Attach the list to the DD Form 2745 and provide a copy to the NDRC. (See table 4-1, page 4-6.)
- Prepare paperwork in English and other applicable languages before releasing detainees.
- Verify collected biometric data.
- Coordinate with legal, police, and penal administrative officials of the HN for the transfer of detainees.
- Coordinate with the media for press coverage of the transfer.

9-47. When I/R operations are conducted in an environment in which a state has failed or will continue to be occupied, leaders consider the following when releasing detainees back into the community:

- Assist in the establishment of internment facilities for the eventual transition of detainees to the HN penal operation.
- Assist with training HN and/or new government personnel in penal and/or detention operations.
- Coordinate with judicial and administrative personnel for the transfer of evidentiary documents and/or materials.
- Establish clear and agreed-upon standards for the release and/or transfer of detainees back to the HN and/or new government.

9-48. Planning considerations for transitioning detainee operations to a HN penal system may include:

- **Penal system template.** Strategic planners and leaders determine the current state of the developing indigenous penal system and the necessary additions or adjustments to be made to achieve a functioning system. A regional penal system template is developed for planners to use to determine the amount of penal system infrastructure and associated resources needed based on the population and regional characteristics of a given area. Planning considerations for regional penal systems range from comparative analysis of existing structures to historical examples used for development purposes and may include the following:
 - Compare the populations of similar regions to the number of persons detained to obtain a holistic analysis which will determine large-scale indigenous penal system requirements.
 - Use lessons learned in historic detainee levels to form detainee-to-population ratios as a functional starting basis for further refinement. A sample template might be a regional facility with 5,000 bed spaces for every 1 million inhabitants. Additionally, the same 1 million inhabitants planning number may lead to a requirement for 200 of the 5,000 bed spaces to be designated for female detainees.
 - Develop templates to capture layered or "bottom up" requirements. For every three 400-bed space, local facilities require one regional level facility in support. The template should also be scalable and account for the various levels of confinement facilities needed within a functional span of control.
 - Adjust templates based on the unique characteristics of the operating environment.
- **Academy organizational structure design template.** Significant preplanning is required to efficiently establish the educational institutions required to train indigenous personnel in penal operations. Planners develop templates early to capture the requirements for standing up training academies that can properly train large numbers of people for sustained periods of time. Military advanced individual training institutions should be modified, as needed, and used as a model for creating academy templates.

- **Juvenile justice/penal program.** Most developed nations recognize the need to handle and treat juvenile offenders differently from other criminals. U.S. policy requires that juvenile detainees be segregated from adult detainees and protected based on their minor status. Early planning must incorporate the requirements to resource, establish, and transition civil juvenile justice and correctional systems according to generally accepted international standards.
- **Assistance and liaison teams.** Once civil authority begins to take shape, the I/R-focused military police should plan to ease out of the “doing” role and into a “teaching, coaching, and mentoring” role. The assistance teams that work with emerging civil authorities require considerable planning and resourcing efforts. Additionally, planners anticipate increased requirements for effective liaison activities at every level of emerging civil penal systems and infrastructure.
- **Indigenous penal system resource planning estimates.** Resource requirements must be developed early regarding the necessary systems, equipment, and infrastructure needed to establish and operate regional penal systems. Military police with I/R expertise provide planners and resource directors with accurate planning estimates for the establishment and day-to-day sustainment of all aspects of penal system administration and operation.
- **Detainee information management system.** Preserving critical information on detainees and, ultimately, transferring that information to civil authorities requires robust detainee management data systems. Criminal information systems capable of tracking corrections based on inmate management information in penal environment applications are critical. Capabilities provided by such systems must meet military police and HUMINT collection requirements (including biometrics) and must be scalable from the local to national level. The system must be unclassified and transferable to civil authorities for criminal and penal applications.

9-49. The key objectives of the transition of detainee operations are numerous and complex. Key players within this transition plan include—

- Department of the State officials, to include public diplomacy personnel.
- Department of Justice.
- DOD.
- U.S. Agency for International Development.
- Foreign governments.
- NGOs and international organizations.
- Private contractors.
- Ministry of interior and local justice and police personnel.

9-50. Key U.S. military considerations include—

- Constructing facilities to ensure that they meet humane treatment standards.
- Estimating fund for infrastructure construction or upgrade.
- Identifying equipment issues for the gaining facility.
- Identifying a transition team to provide oversight.
- Developing a public affairs plan.

9-51. Transition criteria must also be established to determine at what point detainees should be handed over to the HN or a fledgling government. From a penal standpoint, the criteria includes—

- Number and quality of corrections officers trained.
- Number and quality of penal facilities built or refurbished.
- Institutional development.
- Crime rates, especially violent crimes.
- Other crime indicators, such as illegal drug trade.
- Public perception of security and performance of corrections officers.

9-52. From the standpoint of the military and similar organizations, the transition criteria may include—

- Number and quality of personnel trained and institutional facilities built or refurbished.
- Development of reliable local intelligence.

- Number of former combatants who have completed disarmament, demobilization, and reintegration.
- Number and quality of intelligence officials trained, facilities built, and institutions developed.
- The level of political violence and insurgency.
- Public perception of security.
- International military casualties.

9-53. The justice system within the government is another critical component when developing a transition plan. A set of criteria as to when to conduct transition operations may depend on the following standards:

- Number and quality of judges, prosecutors, and trained corrections officers.
- Number and quality of judicial facilities built or refurbished.
- Institutional development of justice bodies, such as a ministry of justice and local and national courts.
- Public perception of justice system effectiveness.
- Public perception of corruption in the justice system.
- Duration of pretrial detention.
- Duration of case movement through the court system.
- Established right to legal advice and due process.

9-54. A detailed plan is critical for ensuring the long-term success of transition operations.

Chapter 10

Resettlement Operations

Resettlement operations occur across the spectrum of military operations. Such operations include civil support operations and foreign humanitarian assistance operations. Events under the category of resettlement operations include relief, CBRNE, civil laws, and community assistance operations. Military police provide support to resettlement operations, which include establishing and operating facilities and supporting CA efforts to ensure that supply routes remain open (mainly linked to the maneuver and mobility support function) and clear to the maneuver commander. Additional tasks that support resettlement operations (conducted within the law and order function) include curfew enforcement, movement restrictions, the use of travel permits and registration cards, proper checkpoint operations, amnesty programs, and inspections. The level of control is typically drastically different from that of most interned persons during detainee operations. During detainee operations, the level of control and supervision is high, based on the significant and evident security risks. During resettlement operations, DCs are allowed freedom of movement as long as such movement does not impede operations. Security risks will always be present, but they should be reduced in most resettlement operations. Counterinsurgency operations may affect, or be affected by, resettlement operations; and ongoing insurgency operations will tend to blur the lines between internment operations and resettlement operations.

INTRODUCTION

10-1. Resettlement operations are conducted to provide security and support for DCs, in conjunction with CA/civil-military operations and HN, NGO, and other military specialties. CA personnel typically lead the initial analysis and assessment, coordination, and liaison with the HN and NGOs regarding resettlement operations. In some instances, conducting resettlement operations minimizes civilian interference with military operations and protects civilians from combat operations. In other instances, resettlement operations may be the main effort, such as during humanitarian relief missions. Resettlement operations are ideally performed with minimal military resources. Nonmilitary international aid organizations, NGOs, and international humanitarian organizations are the preferred resources used to assist CA forces. However, CA forces typically depend on other military units, such as military police, to assist with controlling and securing DCs.

OBJECTIVES AND CONSIDERATIONS

10-2. Often, the primary objective of resettlement operations is to minimize civilian interference with military operations, and this is typically linked to the maneuver and mobility support function. However, the primary or supporting objectives of resettlement operations may also be to—

- Protect DCs from combat operations.
- Prevent and control the outbreak of disease.
- Relieve human suffering.
- Centralize masses of DCs.

10-3. The specific planning focus of resettlement operations may differ at each level of command and will vary depending on the type and nature of detainee operation being performed and other relevant aspects of

the OE. All commands and national and international agencies involved must have clearly defined responsibilities. When planning and executing resettlement operations, consider the following actions:

- Coordinate with the Department of State, the UN Office for the Coordination of Humanitarian Affairs, and HN civil and military authorities to determine the appropriate levels and types of aid required and available.
- Minimize outside contributions (issue basic needs items only) until DCs become self-sufficient, and encourage DCs to become as independent as possible.
- Review the effectiveness of humanitarian responses, and adjust relief activities as necessary.
- Coordinate with CA units to ensure the use of U.S., HN, international, and other organizations (UN Children's Fund, Cooperative for Assistance and Relief Everywhere). Receiving assistance from these organizations capitalizes on their experience and reduces the requirements placed on U.S. armed forces.
- Apply security restrictions, as required, for DCs. Under international laws, DCs have the right to freedom of movement; but in the event of a mass influx of DCs, security considerations may require restrictions.

CIVIL-MILITARY AND RESETTLEMENT OPERATIONS

10-4. Resettlement operations typically require integrated and synchronized civil-military operations. The situation will determine if civil-military operations are supporting resettlement or if resettlement is supporting civil-military operations. CA forces are specially organized, trained, equipped, and suited to perform civil-military operations liaison, to include providing support to resettlement operations, with the varied civil agencies and multinational partners in an operational area. CA forces bridge the gap between U.S. armed forces and HN military and civilian authorities in support of military objectives. They can also provide support to non-U.S. units in multinational operations. (CA participation in detainee operations within the United States may have limitations, and the roles they perform in non-U.S. territories will typically be performed by other U.S. governmental agencies in U.S. territories.)

10-5. Civil-military operations are the activities of a commander that establish, maintain, influence, or exploit relations between U.S. armed forces, governmental and nongovernmental civilian organizations and authorities, and the civilian population in a friendly, neutral, or hostile operational area to facilitate military operations and consolidate and achieve U.S. objectives. Activities conducted by CA personnel enhance the relationship between U.S. armed forces and civil authorities in areas where U.S. armed forces are present. Support by CA personnel also involves the application of their functional specialty skills that are normally the responsibility of the civil government to enhance the conduct of civil-military operations. The contribution of CA forces to an operation centers on their ability to rapidly analyze key civil aspects of the operational area, develop an implementing concept, and assess its impact throughout the operation. (See FM 3-05.40 for more information about CA.)

RESPONSIBILITIES FOR CIVIL AFFAIRS ACTIVITIES

10-6. The President and the Secretary of Defense develop and promulgate the policy that governs CA activities that U.S. commanders perform (in joint and multinational contexts) due to the politico-military nature and sensitivity of these activities.

10-7. CA planning is based on national military strategy and is consistent with a variety of legal obligations, such as those provided for in the U.S. Constitution, statutory laws, judicial decisions, Presidential directives, departmental regulations, and the rules and principles of international laws (especially those incorporated in treaties and agreements applicable to areas where U.S. armed forces are employed).

10-8. CA forces are made available to commanders to maintain proper, prudent, and lawful relations with the civilian population and government indigenous in the operational area. When commanders' operations affect, or are affected by, the indigenous civilian population, resources, government, or other civil institutions or organizations in the operational area, CA forces will be assigned to assist in civil-military operations. (See DODD 2000.13.)

10-9. U.S. Army CA forces are designated as special operations forces. (See Title 10, USC.) All CONUS-based special operations forces are assigned to the U.S. Special Operations Command. CA units are under the combatant command of U.S. Special Operations Command until operational control is given to one of the geographic combatant commanders. U.S. Special Operations Command is the combatant command for special operations forces.

CIVIL AFFAIRS SUPPORT

10-10. The U.S. Special Operations Command coordinates with geographic combatant commanders to validate all requests for CA units and individuals during peace and war. The U.S. Special Operations Command coordinates with each of the Services and then provides CA forces that are organized, trained, and equipped to plan and conduct CA activities in support of a geographic combatant commander's mission. The U.S. Special Operations Command commander has the capability of providing one airborne-qualified CA battalion that—

- Is an Active Army unit that consists of regionally oriented companies.
- Is structured to deploy rapidly.
- Provides initial CA support to military operations.
- Is primarily used to provide rapid, short-duration CA generalist support for nonmobilization contingency operations worldwide.
- Is not designed or resourced to provide the full range of CA functional specialty skills.

10-11. The U.S. Army Special Operations Command is the Army component of the U.S. Special Operations Command. Its mission is to command and support and ensure combat readiness of assigned and attached Army Special Operations Forces. The U.S. Army Special Operations Command has the responsibility, in conjunction with U.S. Special Operations Command, to recruit, organize, train, equip, mobilize, and sustain the Regular Army's only CA brigade. As an Army Service component command, the U.S. Army Special Operations Command's primary missions are—

- Policy development.
- Long-range planning.
- Programming and budgeting.
- Management and distribution of resources.
- Program performance review and evaluation.

10-12. The U.S. Army Civil Affairs and Psychological Operations Command headquarters is a nondeploying, direct-reporting unit to the U.S. Army Reserve Command with the mission to organize, train, equip, monitor the readiness of, validate, and prepare assigned Active Army and U.S. Army Reserve CA forces for deployment. These forces conduct worldwide CA operations in support of civil-military operations, across the spectrum of operations, and in support of the geographic combatant commanders, U.S. Ambassadors, and other agencies as directed by the U.S. Army Special Operations Command.

10-13. The geographic combatant commander organizes the staff to orchestrate joint operations with multinational and interagency activities. Geographic combatant commanders plan, support, and conduct CA activities. They designate a staff element within the headquarters that has the responsibility for coordinating CA activities; combatant commanders receive CA support from the Commander U.S. Special Operations Command. The civil-military operations staff element on the theater echelon staff plays an integral part in this organization. The civil-military operations staff cell of the Theater Special Operations Command provides deliberate and contingency planning, maintenance of existing plans, assessments, and support to the geographic combatant commander. The CA commander supporting each geographic combatant commander serves as the geographic combatant commander's senior CA advisor and as the focal point for civil-military operations, coordination, collaboration, and consensus.

10-14. Normally, C2 of special operations forces is executed within the special operations forces chain of command. The identification of a C2 organizational structure for special operations forces depends on specific objectives, security requirements, and the OE. The Theater Special Operations Command is the joint special operations command through which the geographic combatant commander normally exercises operational control of special operations forces within the area of responsibility (the exceptions are the U.S.

Central Command and U.S. European Command areas of responsibility where the Theater Special Operations Command exercises operational control of CA forces).

10-15. Civil-military operations (assistant chief of staff, civil affairs operations [G-9]/civil affairs staff officer [S-9]) staff elements are typically embedded within the echelon staffs requiring CA support. These staff elements will normally be provided to brigade level, based on specific mission variables and requirements. The civil-military operations staff officer/planner (G-9/S-9) is the principal staff officer for all civil-military operations matters and conducts the initial assessment that determines CA force augmentation. The relationship between the G-9/S-9 primary staff officer to the supporting CA unit is the same relationship as the G-2 to a supporting MI unit. The G-9/S-9 enhances the relationship between military forces and civilian authorities and personnel in the AO to ensure mission success. Responsibilities and functions of the G-9 and S-9 differ due to the operational echelon. The G-9 has staff planning and oversight to—

- Manage assigned and attached CA forces.
- Coordinate all aspects of the relationship between the military force and the civil component in the environment of the supported commander.
- Advise the commander on the effect of military operations on the civilian populations.
- Minimize civilian interference with operations. This includes monitoring resettlement operation curfew, and movement restrictions or deconflicting civilian and military activities with due regard for the safety and rights of refugees and internally displaced persons.
- Advise the commander on legal and moral obligations incurred from the long- and short-term effects (economic, environmental, health) of military operations on civilian populations.
- Coordinate, synchronizing, and integrating civil-military plans, programs, and policies with national and combatant command strategic objectives.
- Advise on the prioritizing and monitoring expenditures of allocated overseas humanitarian disaster and civic aid, commanders emergency response plan, payroll, and other funds dedicated to civil-military operations. The G-9 ensures that subordinate units understand the movement, security, and control of funds. The G-9 coordinates with the funds controlling authority/financial manager to meet the commander's objectives.
- Coordinate and integrating deliberate planning for civil-military operations-related products.
- Augmenting civil-military operations staff.
- Coordinate and integrating area assessments and area studies in support of civil-military operations.
- Support emergency defense and civic-action projects.
- Support the protection of culturally significant sites.
- Support foreign humanitarian assistance and disaster relief.
- Support emergency food, shelter, clothing, and fuel for local civilians.
- Support public order and safety applicable to military operations.

10-16. The functions of the brigade S-9 are to—

- Serve as the staff proponent for the organization, use, and integration of attached CA forces.
- Develop plans, policies, and programs to further the relationship between the brigade and the civil component in the brigade AO.
- Serve as the primary advisor to the brigade commander on the effect of brigade populations on brigade operations.
- Assist in the development of plans, policies, and programs to deconflict civilian activities with military operations within the brigade area of responsibility. This includes resettlement operations, curfews, and movement restrictions.
- Advise the brigade commander on legal and moral obligations incurred from the long- and short-term effects (economic, environmental, health) of brigade operations on civilian populations.
- Coordinate, synchronize, and integrate civil-military plans, programs, and policies with operational objectives.

- Advise on the prioritizing and monitoring of expenditures of allocated funds that are dedicated to civil-military operations and facilitates movement, security, and control of funds to subordinate units. The S-9 coordinates with the funds controlling authority/financial manager to meet the commander's objectives.
- Conduct, coordinate, and integrate deliberate planning for civil-military operations in support of brigade operations.
- Coordinate and integrate area assessments and area studies in support of civil-military operations.
- Advise the brigade commander and staff on the protection of culturally significant sites.
- Facilitate the integration of civil inputs to the brigade common operational picture.
- Advise the brigade commander on the use of military units and assets that can perform civil-military operation missions.

CIVIL AFFAIRS ACTIVITIES

10-17. Under the umbrella of civil-military operations, CA forces perform the following activities:

- Foreign nation support.
- Civil-military actions.
- Support to civil administrations.
- Population and resource control.
- Humanitarian assistance.
- Emergency services.

10-18. Military police units may be deployed and employed in support of civil-military operations anywhere in the world. Military police who are supporting civil-military operations must be briefed and understand the intent of these operations. Police intelligence operations are significant enablers during civil-military operations as is the proper treatment of all categories of detainees and DCs. Having a proper mind set and good situational awareness is critical. U.S. armed forces may be called upon to relieve human suffering (such as that encountered after a natural disaster), and appropriate discipline measures and controls are enacted to meet each situation.

10-19. MI units obtain CA-relevant information gathered in interrogations, and they provide information of intelligence value that is gained from passive collection by CA personnel. Police information and intelligence are also integrated.

10-20. The expertise of CA forces in working crisis situations (conduct of assessments, transition planning, and skills in functions that are normally civil in nature) and their ability to operate with civilian organizations may make them ideal for civil support operations. CA forces should never be considered as a substitute for other U.S. armed forces.

10-21. The information that friendly, adversary, and neutral parties provide has a significant effect on the ability of civil-military operations planners' ability to establish and maintain relations between joint forces; civil authorities; and the general population, resources, and institutions in friendly, neutral, or hostile areas.

10-22. CA forces have the inherent responsibility of population and resource control due to the impact on the civilian population and movement of HN assets and personnel. Population and resource control is conducted through the coordination and synchronization of the activities of multiple civilian agencies and military organizations, to include extensive military police operations. Successfully coordinated and executed population and resource control operations—

- Provide security for the population.
- Deny personnel and material to the enemy.
- Mobilize population and material resources.
- Detect and reduce the effectiveness of enemy agents.

10-23. Population control measures include curfews, movement restrictions, travel permits, registration cards, and resettlement operations. Resource control measures include licensing, regulations or guidelines,

checkpoints, ration controls, amnesty programs, and facility inspections. Most military operations employ some type of population and resource control measures. Resettlement operations are often conducted under the auspices of population and resource control.

SUPPORTING ORGANIZATIONS

10-24. Organizations supporting resettlement operations include numerous participants (military and nonmilitary) with divergent missions. Agencies involved in resettlement operations typically come from the joint community, interagency organizations, NGOs, international organizations, and HN/multinational organizations. The environment exists for potential duplication of effort. Achieving a unified effort requires close coordination, liaison, and common purpose for mission success. (See appendix E for more information.)

PLANNING CONSIDERATIONS

10-25. The planning scope for resettlement operations and the actual task implementation typically differ depending on the command level, and vary depend on the type and nature of detainee operation being performed and other relevant aspects of the OE. Military police must have a basic understanding of the planning CA units conduct for resettlement operations. Except as specifically noted, planning considerations discussed are applicable to all tactical scenarios.

10-26. Based on national policy directives and other political efforts, the theater commander provides directives on the care, control, and disposition of DCs. The resettlement operation plan—

- Includes migration and evacuation procedures.
- Establishes minimum standards of care.
- Defines the status and disposition of DCs.
- Designates routes and movement control measures.
- Identifies cultural and dietary considerations.
- Includes information on DC plans, routes, and areas of concentration.
- Provides measures to relieve suffering.
- Establishes proper order and discipline measures within the facility for the security and safety of DCs and Soldiers.
- Provides an aggressive information program by using support agencies and DC leadership.

INFRASTRUCTURE

10-27. Resettlement operations may require large groups of civilians to be quartered temporarily (less than 6 months) or semipermanently (more than 6 months). Military police may be tasked to set up, administer, and operate facilities in close coordination with CA forces, HN or U.S. governmental agencies, PSYOP units, NGOs, international humanitarian organizations, international organizations, and other interested organizations. A military police unit commander typically becomes the facility commander (although there may be exceptions to this in the case of resettlement operations conducted as part of civil support).

10-28. When possible, facilities are modified or constructed using local agencies, local or supporting governmental employees, and selected DCs as appropriate. The supporting command's logistic and transportation assets acquire and transport materials to build or modify existing facilities, and local sources may provide materials within legal limitations. The supporting command also furnishes medical, subsistence, and other supporting assets to establish resettlement facilities. Engineer support and military construction materials will be necessary in situations where new facilities are established and may be necessary when resettlement facilities are set up in areas where local facilities are unavailable; for example, hotels, schools, halls, theaters, vacant warehouses, and factories identified for use as holding sites for DCs. (See chapter 6 and appendix J.)

10-29. If necessary, military police units set up the facility using acquisitioned tentage and other materials. The facility commander considers the type of construction necessary to satisfy the needs of the resettlement operation. Considerations may include the—

- Local climate.
- Anticipated permanency of the facility.
- Number of facilities to be constructed.
- Availability of local materials.
- Extent of available military resources and assistance.

SECURITY

10-30. The resettlement facility commander is responsible for safety and security. In any size facility, the commander addresses crimes against persons and property, ensures that security patrols are conducted, and conducts necessary quick-reaction force operations. If the commander has a law and order asset task-organized, it typically performs necessary security-related functions. If not, other task-organized assets (a guard company) typically provide the means to conduct necessary security-related tasks.

MEDICAL CARE AND SANITATION FACILITIES

10-31. Due to the temporary nature of a resettlement facility, the need for medical care and sanitation facilities increases. If possible, locate a sick call tent adjacent to each major compound inside the facility to ensure prompt medical screening and treatment. Enforcement and education measures ensure that the facility population complies with basic sanitation measures. Provide medical care via organic I/R medical personnel, or coordinate with the appropriate HN medical authorities. To prevent communicable diseases, follow the guidance in FM 21-10 and other applicable publications. Coordinate with preventive medicine specialists to conduct routine, preplanned health, comfort, and welfare inspections. Inspections are performed to ensure that the facility is safe, sanitary, and hazard-free. (See appendix I.) When conducting inspections—

- Ensure that the purpose of the inspection is conveyed and emphasized to DC leaders.
- Respect cultural beliefs, such as religious tenets and shrines. ICE, international support groups, community leaders, CA forces, and DC leaders are good sources for information regarding cultural sensitivities.
- Treat DCs and their possessions respectfully.

SCREENING

10-32. Screening prevents infiltration by insurgents, enemy agents, or escaped members of hostile armed forces. Although intelligence and other units may screen DCs, friendly and reliable local civilians can perform this function under the supervision of military police and CA forces. Screeners carefully apply administrative controls to prevent infiltration and preclude the alienation of people who are sympathetic to U.S. objectives. The screening process also identifies technicians and professionals to help administer the facility; for example, policemen, teachers, doctors, dentists, nurses, lawyers, mechanics, carpenters, and cooks.

STRATEGIC REPORTING

10-33. Military police will typically be required to account for DCs and report to higher headquarters. This may require the issuance of ISNs or control numbers that are specific to DCs. Commanders conducting resettlement operations ensure a proper understanding of the ISN issuance policy before assigning an ISN to a DC. Even in civil support operations where social security numbers may be used, a supporting system will be required for those without social security numbers.

LEGAL OBLIGATIONS

10-34. All commanders are under the legal obligation imposed by international laws, including the Geneva Conventions and other applicable international humanitarian laws. In particular, commanders must comply with the law of land warfare during all armed conflicts; however, such conflicts are characterized, and during all other military operations. (See FM 27-10.) Within U.S. territories, there are specific legal restrictions governing the use of U.S. military forces. (See JP 3-28.)

LIAISON

10-35. Military police plan liaison with multiple organizations and agencies. Liaison established with all participating agencies (international organizations, NGOs, HN organizations, CA organizations) ensures a unified effort. Liaison elements must be properly trained and equipped to accomplish these necessary tasks.

TRANSPORTATION

10-36. The efficient administration of a resettlement facility requires adequate transportation assets. Since military police units have limited organic transportation assets, the I/R unit movement officer and intergovernmental transportation specialist must coordinate with the HN, NGOs, international humanitarian organizations, or appropriate U.S. governmental agency to determine the types and numbers of vehicles required/available and make provisions to have them on hand and properly supported.

10-37. Directing and controlling movement is vital when handling masses of DCs. CA and HN or U.S. government authorities are responsible for mass resettlement operations, and the military police may help direct DCs to alternate routes. If possible, incorporate HN assets in planning and implementing. This will also be a requirement in civil support operations. Consider the following:

- **Route selection.** When selecting routes for civilian movement, CA personnel consider the types of transportation common to the area. They coordinate the proposed traffic circulation plan with the transportation officer and the PM. All DC movements take place on designated civilian evacuation routes.
- **Route identification.** After designating movement routes, CA personnel ensure that they are marked in languages and symbols that civilians, U.S. armed forces, and multinational forces understand. PSYOP units, military police units, HN military forces, and other multinational military units can help mark routes using agreed upon standards.
- **Control and assembly points.** After selecting and marking movement routes, CA and HN authorities establish control and assembly points at selected key intersections. CA personnel coordinate locations with the PM, the movement control center, and S-4/assistant chief of staff, sustainment (G-4) to include control and assembly points in the traffic circulation plan.
- **Emergency rest areas.** CA personnel set up emergency rest areas at congested points to provide immediate needs (water, food, fuel, maintenance, and medical services). Notify the PM to ensure that these areas are included in military police area security operations.
- **Local and national agencies.** Using local and national agencies conserves military resources and reduces the need for interpreters and translators. Civilian authorities normally have legal status and are best-equipped to handle their own people.

RELOCATION OF POPULATION

10-38. The final step in resettlement operations is the disposition of DCs. Allowing DCs to return to their homes as quickly as tactical (or other situational) considerations permit lessens the burden on military and civilian economies. It also reduces the danger of diseases that are common among people in confined areas. When DCs return home, they can help restore their towns and can better contribute to their own support. If DCs cannot return home, they may resettle elsewhere in their country or in a country that accepts them. Guidance on the disposition of DCs comes from higher authority upon coordination with U.S. armed forces, national authorities, and international agencies.

10-39. The most important step in the disposition of DCs is the final handling of personnel and property. Before the DC operation is terminated, the resettlement facility commander consults with higher headquarters, the SJA, and other pertinent agencies to determine the proper disposition of records.

MILITARY POLICE SUPPORT TO RESETTLEMENT OPERATIONS

10-40. Resettlement operations typically include controlling civilian movement and providing relief to human suffering. These operations may be performed as domestic civil support operations (due to natural or man-made disasters), stability operations (due to noncombatant evacuation operations, humanitarian-assistance operations), or DC operations (due to combat operations). The authority to approve resettlement such operations within U.S. territories is at the Secretary of Defense level and may require a special exception to Title 18, USC (Posse Comitatus Act). The Posse Comitatus Act prohibits the U.S. military from enforcing civilian laws within the United States or its territories without specific authorization. The U.S. Constitution and other federal, state, and local laws may directly and significantly affect operations in the U.S. and its territories if the enforcement of civilian laws are required according to Title 10, USC. U.S. military forces conducting law enforcement functions in such cases require an authorization through a congressional act (for example, Title 10 USC, Sections 331 through 334 [Insurrection Statutes]) or a constitutional authorization (for example the President invoking his executive authority under Article 2 of the Constitution). U.S. Army National Guard Soldiers operating in a nonfederal status are not restricted by the Posse Comitatus Act. (See Title 32, USC, and JP 3-28.)

10-41. Military police support these operations predominately by decreasing civilian interference with military operations, by protecting civilians from combat operations or other threats (including natural and man-made disasters), and by establishing resettlement facilities in support of CA operations. When the joint force commander determines that there is a need, a variety of military police units may be deployed to assist in accomplishing the resettlement mission.

10-42. Once the decision is made to employ a military police unit to support resettlement operations, the military police commander becomes the resettlement facility commander. The resettlement facility commander and staff must have a thorough understanding of the legal considerations, the joint force commander's concept of operations, and how each applies to the military police mission. If time permits, the resettlement facility commander makes contact with the joint force commander plans officer, civil affairs staff officer, SJA, and other organizations that may have a role in the operation. Intergovernmental agencies can provide resettlement facility personnel with expertise on factors that directly affect the operation.

10-43. A properly configured modular I/R battalion can support, safeguard, account for, and guard 8,000 DCs while ensuring that they are treated humanely. The support of resettlement operations begins before a military police unit arrives in the theater or is tasked with the mission. CA forces provide military police leaders and Soldiers with expertise on factors that directly affect resettlement operations. These factors include, but are not limited to—

- HN agencies.
- Status of infrastructure that will hold DCs.
- Ethnic differences and resentments.
- Social structures (family and regional).
- Religious and cultural systems (beliefs and behaviors).
- Political systems (distribution of power).
- Economic systems (sources and distribution of wealth).
- Links between social, religious, political, and economic systems.
- Cultural history of the area.
- Attitudes toward U.S. armed forces.
- Sustainment requirements.

10-44. Military police leaders remain in close coordination and continuous liaison with the agencies involved in operating the resettlement facility. Responsibilities may include—

- Selecting the facility location, constructing it, and setting it up.
- Determining processing, screening, classification, and identification requirements.

- Providing clothing, equipment, and subsistence.
- Providing medical care, veterinary support, and sanitation facilities.
- Maintaining discipline, control, administration, and law and order.
- Determining ROI and ROE.
- Determining transportation requirements.

10-45. Major sections of a resettlement facility normally include a headquarters facility, clinic, dining facility, personal hygiene facilities, sleeping areas, and animal compounds. Sleeping areas must be segregated for families, unaccompanied children, unattached females, and unattached males. Cultural and religious practices may be important considerations. Efforts are made to keep families together when assigning billets. Appendix J shows a sample DC resettlement facility. Additional facilities, fencing, and other requirements are based on the—

- Number of civilians housed.
- Diversity of the population housed.
- Resources available.
- Need for a reactionary force.
- Need for an animal compound.
- Facility duration.

PROCESSING

10-46. The initial processing begins with the transport of civilians to the resettlement facility. The HN (in coordination with NGOs, international organizations, and/or international humanitarian organizations) normally assists in arranging transportation for DCs. The processing is done in a positive manner because these civilians may be fearful and in a state of shock. Civilians should understand why they are being processed and know what to expect at each station. This is accomplished by the facility commander ensuring that all DCs, HN representatives, other officials receive an entrance briefing upon their arrival. The briefing is provided in the native language of the DCs. If there is more than one language represented, the briefing is provided in multiple languages to meet all language requirements.

10-47. While the processing procedures discussed in chapters 4 and 5 provide a foundation, I/R personnel must be aware of unique aspects to consider when processing DCs. Military personnel provide training and support, while NGOs, international humanitarian organizations, international organizations, or other U.S. agencies typically process DCs. In the absence of NGOs, international humanitarian organizations, international organizations, or other appropriate U.S. agencies, military personnel may perform the functions in table 10-1. The number and type of processing stations vary from operation to operation. Table 10-1 shows stations that are typically required during resettlement operations.

Table 10-1. Actions during inprocessing

Station	Purpose	Responsible Individuals*	Actions
1	Search and screen	I/R staff, MI personnel, NGOs, IHOs, and IOs	Conduct a pat-down search to ensure that weapons are not brought into the facility and that the facility is not infiltrated by insurgents.
2	Accountability	I/R staff	Prepare forms and records to maintain the accountability of DCs. Use forms and records provided by the HN or CA personnel or forms and records used for detainee operations that may apply to DCs.
3	Identification card or band	I/R staff	Issue an identification card or band to each DC, if required, to ease facility administration and control.
4	Medical evaluation	Medical personnel	Evaluate DCs for signs of illness or injury, and treat them as necessary.

Table 10-1. Actions during inprocessing (continued)

Station	Purpose	Responsible Individuals*	Actions
5	Assignment	I/R staff	Assign a sleeping area to each DC.
6	Personal items	I/R staff	Issue personal-comfort items and clothing if available.
* The number of people performing these tasks depends on the number of DCs and the time available. Allow HN authorities to conduct most of the processing when possible.			
Legend:			
CA	civil affairs		
DC	dislocated civilian		
HN	host nation		
IHO	international humanitarian organization		
IO	international organization		
I/R	internment and resettlement		
MI	military intelligence		
NGO	nongovernmental organization		

10-48. The resettlement facility commander determines the accountability procedures and requirements necessary for resettlement operations. Translators are present throughout processing. A senior member of the facility staff greets new arrivals and makes them feel welcome. DCs are briefed on resettlement facility policies and procedures and screened to identify security and medical concerns. They are offered the use of personal hygiene facilities. Family integrity is always maintained if possible.

10-49. Searches are conducted of arriving DCs to ensure that weapons are not brought into the resettlement facility. Same-gender searches are conducted when possible, and strip searches are never conducted without special authority and only in unique situations. Speed and security considerations may require mixed-gender searches. If so, perform them in a respectful manner, using all possible measures to prevent any action that could be interpreted as sexual molestation or assault. The onsite supervisor carefully controls Soldiers doing mixed-gender searches to prevent allegations of sexual misconduct. Using HN, NGO, or international humanitarian organization personnel to conduct searches may prevent negative situations from developing.

DISLOCATED CIVILIAN OPERATIONS

10-50. Resettlement operations are performed across the spectrum of operations, especially in stability and civil support operations. Planning and conducting resettlement operations is the most basic collective task performed by CA forces. Additional agencies (such as nonmilitary international aid organizations, NGOs, and international humanitarian organizations) are the primary resources that CA forces use. However, when needed, CA forces may depend on other military units (military police assets) to assist with a particular category of civilians during resettlement operations.

10-51. Controlling DCs is essential during military operations because uncontrolled masses of people can seriously impair the military mission. Commanders plan measures to protect DCs in the operational area or AO to prevent their interference with the mission. Major natural and man-made disasters, large numbers of refugees or migrants crossing international borders, and other situations resulting in significant personnel displacement may quickly overwhelm local logistics capabilities, requiring a significant military response to prevent human suffering. The military police commander and staff must have a clear understanding of the OE, ROE, and legal considerations before establishing a resettlement facility in support of resettlement operations.

10-52. During military operations, U.S. armed forces must consider two distinct categories of civilians—

- **Those who remain in place.** This category includes individuals who are indigenous to the area and the local population, including individuals from other countries. These persons may or may not require assistance. If no assistance is required and the safety of the civilians is not an issue, they should remain in place.

- **Those who are dislocated.** This category includes individuals who have left their homes for various reasons. They are categorized as DCs, and their movement and physical presence can hinder military operations. They probably require some degree of aid (medicine, food, clothing, water, shelter) and may not be native to the area or the country.

Note. Categories of DCs are discussed in depth in chapter 1.

PLANNING RESETTLEMENT OPERATIONS

10-53. The planning scope for resettlement operations and the actual task implementation differ, depending on the command level and the theater of operations. Before conducting resettlement operations, military police leaders must have a basic understanding of how CA forces plan resettlement operations. Except as specifically noted, planning considerations discussed in this manual are also applicable to tactical scenarios.

10-54. Military police classify DCs during processing. They coordinate with CA personnel, NGOs, international humanitarian organizations, and international organizations to determine proper classifications. I/R personnel can expect a continuing need for reclassification and reassignment of DCs. Statements made by DCs and the information on their identification papers determine their initial classifications. Agitators, enemy plants, and individuals who may be classified as detainees are identified by their activities. DCs may be reclassified according to their proper identity and/or ideology through a CI review tribunal. If a DC is reclassified as a detainee, he or she will be transferred to a TIF or SIF.

10-55. Active police intelligence operations conducted within and around the resettlement facility are critical to maintaining order and security. Through active and passive collection activities, criminals, agitators, enemy plants, and other disruptive elements can be identified early and measures taken to mitigate (or remove) these elements and their activities prior to significant negative impacts on the facility and the personnel living and operating within the facility.

10-56. Identifying DCs may or may not be necessary; it depends on guidance from higher headquarters, CA units, the HN, and other agencies. The need to identify DCs varies from operation to operation. DC identification may be necessary for the following reasons:

- To verify rosters against the actual population.
- To provide timely reunification of family members.
- To match DCs with their medical records in case of a medical emergency or evacuation.
- To check the identities of DCs against the transfer roster.
- To identify personnel being sought by HN, multinational, or U.S. forces.

10-57. The NDRC has the ability to assist commanders in establishing an automated Detainee Reporting System to process DCs. (See chapter 1.) This portable Detainee Reporting System (jump kits) will assist in processing identification cards, ISNs, and demographic information. An identification card is used to facilitate the identification of a DC. It contains the DC's name, photograph, and control number. The control number may be an ISN or a sequenced control number specific to the DC. Identification cards or bands permit identification by categories. (See chapter 1.) An identification band permits rapid, reliable identification of an individual and may also be used in resettlement operations. While DCs cannot be prevented from removing or destroying identification bands, most will accept their use for identification purposes. When identification bands or cards deteriorate, replace them immediately.

CLOTHING AND EQUIPMENT

10-58. DCs should be supplied with adequate, suitable clothing and sleeping equipment if they do not have supplies with them. Requisition clothing and equipment through NGOs, international humanitarian organizations, international organizations, and HN sources when possible. In a combat environment, use available captured clothing and equipment. Ensure that DCs wear clothing until it is unserviceable, and replace it as necessary.

SUBSISTENCE

10-59. Ensure that food rations are sufficient in quantity, quality, and variety to maintain health and prevent weight loss and nutritional deficiencies. Consider the habitual diet of the DC population, and be aware that DCs may bring their own rations and cooking utensils. Allow DCs to prepare their own meals after coordination with CA personnel, the HN, NGOs, international humanitarian organizations, and international organizations.

10-60. Ensure that expectant and nursing mothers and children under the age of 15 receive additional food in proportion to their needs. Increase the rations of workers based on the type of labor they are performing. Provide plenty of fresh water.

10-61. Make minimal menu and feeding schedule changes to prevent unrest among the DC population. Inform the DC leadership when changes must be made.

DINING FACILITIES

10-62. Dining facility requirements vary depending on the number of DCs and the availability of equipment. If deemed necessary, the resettlement facility commander can authorize the local procurement of cooking equipment. Consult with the SJA to determine the purchasing mechanism and the legality of items being purchased. Coordinate with NGOs, international humanitarian organizations, and international organizations for food service support. Train selected DCs to perform food service operations, and ensure that they are constantly supervised by U.S. food service personnel.

SELF-GOVERNMENT

10-63. The resettlement facility commander must determine whether the establishment of self-government is required and appropriate. If responding to a natural disaster, such as an earthquake, the civilian government may not be affected and the resettlement facility may be solely used as shelter. However, if the civilian government cannot be established or is nonoperational, the resettlement facility commander must determine if the implementation of self-government is appropriate.

10-64. If needed, self-government leaders can greatly assist in solving problems before they become major events. An infrastructure of self-government also helps promote a stable environment where rapport can be built between the facility commander, the civilian leadership, and the general civilian population. This, in turn, will provide an effective means of communicating reliable information to the resettlement facility population, thus reducing tension.

10-65. DCs may make complaints and requests to the resettlement facility commander, who will try to resolve the issue. These complaints may be voiced by—

- Elected civilian representatives.
- A written complaint addressed to the resettlement facility commander.
- A visiting representative of the UN High Commissioner for Refugees or other agencies.

CONTROL AND DISCIPLINE

10-66. Controlling of the population is key to successful facility operations. Civilians housed in resettlement facilities during resettlement operations are not prisoners, and this affects the rules and guidelines drafted to support these operations. Measures needed to maintain discipline and security are established and rigidly enforced in each resettlement facility to ensure good order and discipline and minimize the possibility of unstable conditions that would negatively affect efforts to assist the DCs. The resettlement facility commander establishes rules that can be easily followed by everyone in the facility and ensures that they are understood. The resettlement facility commander coordinates with the SJA and HN or U.S. government authorities to determine how to enforce the rules and how to deal with DCs that violate facility rules.

10-67. The resettlement facility commander publishes, enforces, and updates the rules of conduct as necessary. The commander serves as the single point of contact, coordinating all matters within the

resettlement facility and with outside organizations or agencies. Facility rules are brief, but clear, and kept to a minimum. The rules in figure 10-1 are similar to those used in support of Operation New Arrivals in August 1975 at Indiantown Gap, Pennsylvania. They also parallel the rules posted in support of Panama's Operations Just Cause and Promote Liberty and Hurricane Katrina relief operations in New Orleans.

1. Do not move from assigned barracks without permission.
Note. Military police in an I/R facility assign individuals to designated barracks. Only the administrative staff can change barracks assignments. Occupants desiring to change barracks must request permission from the area office.
2. Maintain the sanitary and physical condition of the barracks.
Note. Barracks chiefs organize occupants to perform these tasks.
3. Empty and wash trash cans daily, and put the trash into the trash dumpsters in the barracks area.
4. Do not bring food or cooking utensils into the barracks. Do not take food from the dining area (other than baby food and fruit).
5. Do not have weapons of any kind in the barracks and in the surrounding facility.
6. Do not have pets in the barracks. Pets are contained in the animal compound.
7. Observe the barracks lights-out time of 2300. Barracks indoor lights are turned out at 2300 each night. Do not play radios or compact disc players after 2300.
8. Do not allow children to play on the fire escape because it is very dangerous.
9. Watch children carefully, and do not allow them to wander out of the residence areas.
10. Do not throw diapers or sanitary napkins in toilets. Place these items in trash cans.
11. Do not allow children to chase or play with wild animals. These animals may bite and carry diseases.
12. Obtain necessary barracks supplies from the barracks chief.
13. Do not smoke, use electrical appliances for heating or cooking, or have open fires in the barracks. Military police should designate a location for cooking and/or heating food.

Figure 10-1. Sample facility rules

10-68. Control and discipline also apply to resettlement facility personnel. They must quickly and fairly establish and maintain rigorous self-discipline when operating in resettlement facilities. Resettlement facility personnel—

- Maintain a professional, but impartial, attitude.
- Follow the guidelines established in the ROI and/or ROE.
- Cope calmly with hostile or unruly behavior or incidents.
- Take fair, yet immediate, decisive action.

10-69. The resettlement facility commander takes positive action to establish daily or periodic routines and responses that are conducive to good discipline and control. Resettlement facility personnel—

- Enforce policies and procedures that provide the control of facility residents.
- Give reasonable, decisive orders to DCs in a language they understand.
- Post facility rules, regulations, instructions, notices, orders, and announcements that facility residents are expected to obey in an easily accessible area. This information is printed in a language understood by the DCs. Those individuals who do not have access to the posted copies will be given a copy.
- Ensure that DCs obey orders, rules, and directives.
- Report DCs who refuse or fail to obey an order or regulation.
- Not fraternize with DCs.
- Not donate gifts or receive gifts from or engage in any commercial activity with DCs.

ADMINISTRATION

10-70. DCs should become involved in facility administration. With the large numbers of civilians requiring control and care, it is preferred that they assist as cadre for facility administration. Civilian personnel performing cadre functions are trained and organized by resettlement facility personnel. Problems might arise as a result of the state of mind of the civilians. The difficulties they have experienced may affect their acceptance of authority. The facility commander can minimize difficulties by—

- Maintaining different national and cultural groups in separate facilities or sections of the facility.
- Keeping families together, while separating unaccompanied adult males, adult females, and children under the age of 18 (or abiding by the laws of the HN as to when a child becomes an adult).
- Allowing DCs to speak freely to facility officials.
- Involving the DCs in facility administration, work, and recreation.
- Quickly establishing contact with agencies for aid and family reunification.

10-71. Additionally, the facility commander must ensure that all DCs are treated according to the minimum basic human standards by—

- Not restricting their movement, other than those that are necessary in the interests of public health and order.
- Allowing them to enjoy the fundamental rights internationally recognized, particularly those set out in the Universal Declaration of Human Rights.
- Treating them as persons whose plight requires special understanding and sympathy. They should receive necessary assistance and should not be subjected to cruel, inhumane, or degrading treatment.
- Not discriminating against them on the grounds of race, religion, political opinion, nationality, or country of origin.
- Remembering that they are persons before the law, enjoying free access to the courts of law and other competent administrative authorities.
- Providing them with the necessities of life (food, shelter, basic sanitary and health facilities).
- Maintaining them in family units when possible.
- Providing them with all possible assistance for tracing lost relatives.
- Establishing adequate provisions for the protection of minors and unaccompanied children.
- Allowing them to send and receive mail.
- Permitting friends and relatives to provide material assistance to them.
- Making appropriate arrangements, where possible, for the registration of births, deaths, and marriages.
- Granting the necessary means that enable them to obtain a satisfactory, durable solution.
- Permitting them to transfer assets that they brought into the territory to the country where the durable solution is obtained.
- Taking steps to facilitate voluntary repatriation.
- Affording them humane treatment and protecting them against acts of violence, intimidation, insults, and public curiosity.

10-72. In the administration of any of resettlement facility, the dissemination of instructions and information to the facility population is vital. Communication may be in the form of notices on bulletin boards, posters, public address systems, loudspeakers, facility meetings assemblies, or a facility radio station. CA and PSYOP units may be able to help with the information dissemination effort.

10-73. Another tool in the effective administration of a resettlement facility is the use of liaison personnel. Liaison involves coordination with all interested agencies. U.S. government and military authorities, multinational liaison officers, representatives of local governments, and international agencies help in relief and assistance operations.

SECURITY CONSIDERATIONS

10-74. The exact location of the military police station depends on the facility layout and needs of the commander. Internal and external patrols are necessary; however, security for a resettlement facility should not give the impression that the facility is a prison. Military police patrol areas and the distribution plan are based on the size of the facility and the number of civilians housed inside each subdivision. FM 19-10 and FM 3-19.13 provide basic guidelines for law and order operations and investigations.

10-75. Additional sources for security officers may include HN police, security forces, or other military forces. Another potential source of security may come from the facility population itself. Police personnel within the population might supplement security teams or constitute a special facility police force if appropriate. When supporting civil support operations, civilian police will normally be used to conduct law enforcement functions within a facility. National Guard Soldiers operating under Title 32, USC, may also be used by their respective state governors to perform law enforcement functions.

10-76. Before a civilian is apprehended, the resettlement facility commander must coordinate with SJA and HN authorities to determine the following:

- Jurisdiction over the population.
- Authority to detain.
- Disposition and status of DCs.
- Disposition of case paperwork.
- Disposition of evidence, to include crime laboratory analysis results.
- Disposition of recovered property.
- Procedures and agreements unique to the supported HN.

10-77. The facility commander is prepared to perform operations to restore law and order by identifying a reaction force that can be immediately deployed and employed inside the facility to bring disturbances under control. The size of the reaction force depends on the size of the population and the available military forces. The reaction force is well trained, organized, and knowledgeable of applicable ROE, the use of force policy, and the use of NLWs and civil disturbance measures. (See appendix H for more information on the use of force, NLWs, and additional civil disturbance measures; and FM 3-19.15 for more information on civil disturbance operations.)

RULES OF INTERACTION

10-78. ROI provide Soldiers with a guide for interacting with the civilian population. ROIs include—

- Treating all DCs humanely and with respect.
- Avoiding discussions of politics and policies with DCs.
- Avoiding promises. If cornered, reply with “I will see what I can do.”
- Refraining from making obscene gestures. DCs may understand the meaning.
- Avoiding derogatory remarks. DCs may understand English and the local linguists surely do.
- Treating all DCs equally. DCs may become offended if they do not receive the same treatment or resources that other DCs receive.
- Respecting religious articles and materials.
- Treating medical problems seriously.
- Greeting DCs in their native language.
- Ensuring that any phrase taught by a DC to a Soldier is cleared through a linguist to ensure that it does not contain any obscenities.

RULES FOR THE USE OF FORCE

10-79. RUF used in resettlement operations vary from operation to operation. The combatant commander establishes RUF, in conjunction with the SJA and upon joint staff approval, and approves special RUF developed for use in resettlement facilities. The RUF evolve to fit the changing environment, ensuring continued protection and safety for the DC population and U.S. military personnel. Ensure that RUF remain

simple and understandable so that Soldiers are not confused and do not have to memorize extensive checklists. Standing RUF apply to Title 10 military police conducting operations in the United States and its territories, absent any explicit additional guidance from Secretary of Defense, Commanders may also submit supplemental RUF requests for the Secretary of Defense's approval.

10-80. Nonlethal measures can and may be authorized by the RUF during an operation to protect Soldiers and DCs from injury. NLWs may include riot batons, pepper spray, stun guns, and shotguns loaded with nonlethal munitions. The RUF may include less-than-lethal force to protect mission-essential equipment from damage or destruction. Mission-essential equipment includes tactical and nontactical vehicles, communications equipment, weapons, computers, and office and personal equipment.

This page intentionally left blank.

Appendix A

Metric Conversion Chart

This appendix complies with AR 25-30 which states that weights, distances, quantities, and measures contained in Army publications will be expressed in both U.S. standard and metric units. Table A-1 is a metric conversion chart.

Table A-1. Metric conversion chart

<i>U.S. Units</i>	<i>Multiplied By</i>	<i>Equals Metric Units</i>
Feet	00.30480	Meters
Inches	02.54000	Centimeters
Inches	00.02540	Meters
Inches	25.40010	Millimeters
Pounds	00.45359	Kilograms
Yards	00.91440	Meters
<i>Metric Units</i>	<i>Multiplied By</i>	<i>Equals U.S. Units</i>
Centimeters	00.39370	Inches
Meters	03.28080	Feet
Meters	39.37000	Inches
Meters	01.09361	Yards
Millimeters	00.03937	Inches
Kilograms	02.20460	Pounds

This page intentionally left blank.

Appendix B

Primary Military Police Units Involved With Internment and Resettlement

This appendix provides a synopsis of various units from the Military Police Corps that typically support I/R operations within a theater of operations. It also lists their primary capabilities and roles relating to the support of I/R operations. (See FM 3-39.)

MILITARY POLICE COMMAND

B-1. The MPC is typically assigned to an Army Service component command, and its commander usually serves as the theater CDO. This unit provides the following capabilities to the supported commander:

- C2, staff planning, and supervision for all military police functions (including I/R operations) performed by assigned or attached military police organizations at the theater level.
- C2 for nonmilitary police organizations operating in support of military police functions at the theater level.
- Implementation of theater-wide standards and compliance with established DOD and DA detainee policies.
- Tactical/operational control with augmentation of a tactical combat force, conducting theater level response force operations as required.

MILITARY POLICE BRIGADE

B-2. The military police brigade is typically assigned to an MPC, Army Service component command, or corps. In special situations, it may be assigned to a division. Its commander usually serves as the CDO in the absence of an MPC, but the brigade may require augmentation from an MPC. This unit provides the following capabilities to the supported commander:

- C2, staff planning, and supervision for all military police functions (including I/R operations) performed by assigned/attached military police organizations at the theater, corps, or division level.
- C2 for up to five military police battalions.
- C2 for nonmilitary police organizations operating in support of military police functions at the theater, corps, or division level.
- C2 for the TDRC when the MPC is not required in the theater of operations.

INTERNMENT AND RESETTLEMENT BATTALION

B-3. The I/R battalion is typically assigned to a military police brigade or an MEB, and its commander may serve as the facility commander for a TIF. In small-scale contingency operations, it is possible that the battalion commander may also serve as the CDO. This unit provides the following capabilities to the supported commander:

- C2, staff planning, and supervision for long-term I/R operations.
- C2 for I/R, military police, and guard companies when these units are performing I/R operations. A battalion normally includes a headquarters and headquarters company, 3 organic I/R detachments (consisting of 24 Soldiers each), and a combination of 2 to 5 I/R and guard companies. When task-organized as described above, the I/R battalion can typically provide operational control for a TIF, interning up to 4,000 compliant detainees, 300 noncompliant detainees, or 8,000 DCs.

MILITARY POLICE BATTALION

B-4. The military police battalion is typically assigned to a military police brigade or an MEB. This unit provides the following capabilities to the supported commander:

- C2 for short-term I/R operations at the brigade, division, or corps level.
- The same capabilities as an I/R battalion for long-term I/R operations when properly augmented, equipped, and task-organized.
- C2 to one or more DHAs and/or DCPs.

INTERNMENT AND RESETTLEMENT COMPANY

B-5. The I/R company is typically assigned to an I/R battalion, but may be assigned to a military police battalion or brigade. This unit provides the following capabilities to the supported commander:

- A capability for stand-alone, long-term I/R operations.
- Staff augmentation to a battalion in support of prisoner administration and sustainment functions within an I/R facility.
- Custody and control in stand-alone operations for up to 100 high-risk detainees or 300 U.S. military prisoners.
- Missions as part of a battalion level operation. An I/R company provides C2 to support the operation of one enclosure inside a TIF for up to 1,000 detainees or 2,000 DCs. It normally has operational control of an I/R detachment assigned to the battalion and is responsible for the accountability of detainees/DCs and the operation of compounds within their enclosure.

GUARD COMPANY

B-6. The guard company is assigned to an I/R or military police battalion. This unit provides the following capabilities to the supported commander:

- Security for the confinement of up to 900 U.S. military prisoners.
- Security of up to 4,000 compliant detainees, 600 high-risk detainees, or 300 noncompliant detainees when task-organized under an I/R battalion.
- Individual detainee escort.
- Guards for detainees at medical facilities that are separate from I/R facilities.
- Security and law enforcement for up to 8,000 DCs.

MILITARY POLICE COMPANY

B-7. The military police company is typically assigned to a military police or I/R battalion. It may also be assigned to a BCT or an ACR as a C2 element for more than one military police platoon. This unit provides the following capabilities to the supported commander:

- Functionality as a guard company.
- Detainee escort guards and security during the transfer of detainees.
- Facilitation of DC movement.
- Selected detainee transport security, protection, and security patrols for TIFs.
- Operation and execution of detainee operations at a DHA or one or more DCPs.

INTERNMENT AND RESETTLEMENT DETACHMENT

B-8. The I/R detachment is typically assigned to an I/R battalion. This unit provides the following capabilities to the supported commander:

- A capability for long-term I/R facility operations as part of a battalion level operation.
- C2 of one enclosure of housing up to 1,000 detainees or 2,000 DCs.
- Staff augmentation to a battalion headquarters for administration and sustainment functions at the facility.

THEATER DETAINEE REPORTING CENTER

B-9. The TDRC is a modular organization that is capable of breaking down into four, nine-person teams that are deployable in support of smaller contingency operations at the team level. It is typically assigned to the MPC, but may be assigned to the military police brigade. This capability is required when there is more than one detention facility reporting information to the NDRC at Headquarters, DA. This unit provides the following capabilities to the supported commander:

- A centralized theater agency for the receipt, processing, maintenance, dissemination, and transmittal of data and the status of property pertaining to I/R operations within a theater of operations.
- Operation at the theater level, but can be directly linked to a TIF.

INTERMENT AND RESETTLEMENT CAMP LIAISON DETACHMENT

B-10. The I/R camp liaison detachment is typically assigned to a military police brigade. This unit provides the following capabilities to the supported commander:

- Continuous accountability of detainees who have been captured by U.S. armed forces and transferred to the control of HN or multinational forces.
- Custody and care monitoring of U.S. captured detainees being interned by HN or multinational forces according to the Geneva Conventions.
- Receipt and certification of multinational and HN requests for reimbursement of expenses associated with interning detainees captured by U.S. forces.

INTERMENT AND RESETTLEMENT BRIGADE LIAISON DETACHMENT

B-11. The I/R brigade liaison detachment is typically assigned to a military police brigade (in a ratio of one detachment per three I/R battalions). This detachment provides the following capabilities to the supported commander:

- Staff augmentation to expand military police brigade planning, coordination, and C2 for detainee operations.
- I/R staff augmentation and a liaison link to the HN or multinational forces to ensure that the care and handling of detainees captured by U.S. armed forces is in compliance with international treaties.

INTERMENT AND RESETTLEMENT INFORMATION CENTER

B-12. The I/R information center is typically assigned to a military police brigade. This unit provides the following capabilities to the supported commander:

- A central agency in the theater for the receipt, processing, maintenance, and dissemination (to authorized agencies) of required detainee and DC information.
- A central locator system for detainee personnel and detainees transferred to multinational or HN authorities.

MILITARY WORKING DOGS

B-13. MWDs are typically assigned to an MPC or a military police brigade. There are three types of military police MWD elements capable of supporting I/R operations: kennel master, explosives/patrol team, and narcotics/patrol team. Collectively, they provide the following capabilities to the supported commander:

- Reinforcement of security measures against penetration and attack by small enemy forces.
- Detection of narcotics or explosives.
- A deterrence to escape attempts during external work details.
- External facility security patrols as a deterrence to escape attempts.

This page intentionally left blank.

Appendix C

Contractor Support

Government contractors may be used to provide support to U.S. armed forces. Commanders must fully understand their role in planning for and managing contractors on the battlefield and ensure that their staffs are trained to plan for and manage contractor support. This appendix provides basic information on contractor support considerations and highlights some of the most likely contractors to support I/R operations. (See FM 3-100.21 and FM 100-10-2.) Military units receive guidance and instructions to conduct an operation from published plans and orders, usually operation plans and orders. These plans and orders describe the mission and the manner in which an operation will be accomplished. Contractors receive similar guidance via their contracts. A contract is a legally enforceable agreement between two or more parties for the exchange of products and/or services. It is the vehicle through which the military details the tasks that it wants a contractor to accomplish. It also specifies the monetary amount that the contractor will receive in return for the products and services rendered. There are many different entities represented in a contract. The following paragraphs identify those entities and their responsibilities.

CONTRACTORS

C-1. Contractors are persons or businesses, including authorized subcontractors, that provide products or services for monetary compensation. A contractor furnishes supplies or services or performs work at a stated price or rate based on the terms of a contract. (See AR 715-9 and FM 3-100.21.)

C-2. In military operations, a contractor may provide life support, construction and/or engineering support, weapon systems support, and/or other technical services. The contractor may be required to provide one or multiple types of support.

REQUIRING UNIT

C-3. All requiring units are responsible for providing contracting and contractor oversight in the operational area or the respective AO through appointed contracting officer representatives, to include submitting contractor accountability and visibility reports as required.

C-4. A contracting officer is the official with the legal authority to enter into, administer, and/or terminate contracts. Within the Army, a contracting officer is appointed in writing using SF 1402 (*Certificate of Appointment*). Only contracting officers who are duly appointed in writing are authorized to obligate funds of the U.S. government. Regular Army and reserve component military personnel and DOD civilian personnel may serve as contracting officers supporting deployed forces. The three types of contracting officers are—

- Procuring contracting officer.
- Administrative contracting officer.
- Terminating contracting officer.

C-5. Commanders will primarily work with procuring contracting officers and administrative contracting officers. (See FM 100-10-2.)

CONTRACTING OFFICER REPRESENTATIVE

C-6. The contracting officer representative is an individual appointed in writing by a contracting officer to act as the eyes and ears of the contracting officer. This individual is not normally a member of the Army's contracting organizations, such as the Army Service component command office, but most often comes from the requiring unit.

C-7. In all cases, the contracting officer assigns the contracting officer representative responsibilities (in writing) and authority limitations. The contracting officer representative represents the contracting officer only to the extent delegated in the written appointment. The contracting officer representative does not have the authority to change the terms and conditions of a contract. When the MPC, military police brigade, or military police or I/R battalion is the requiring unit, it must have trained contracting officer representatives to coordinate and accomplish this mission.

STATEMENT OF WORK

C-8. A statement of work defines the government's requirements in a clear, concise language that identifies the specific work to be accomplished. It is incorporated into the contract and is the contractor's mission statement.

C-9. Statements of work are prepared by the requiring unit and must be individually tailored to consider the time period of performance, deliverable items (if any), and desired degree of performance. The work to be performed is described in terms of identifying the government's required products. Any requirements beyond the statement of work may expose the government to claims and increased costs.

CONTRACTOR MANAGEMENT

C-10. Contractor management is accomplished through a responsible contracting organization, not the chain of command. Command authority over contractors in support of military operations is somewhat limited when compared to the authority over military personnel and DA civilians. Contractor personnel are managed according to their performance work statements, which should clearly state that contractor personnel must follow the local protection and safety directives and policies. Commanders must manage contractors through the contracting officer or assistant contracting officer. Contracting officer representatives are appointed by contracting officers in coordination with the requiring unit to ensure that a contractor performs the work required according to the terms and conditions of the contract and federal acquisition regulations. The contracting officer representative serves as a form of liaison between the contractor, supported unit, and contracting officer.

C-11. The management and control of contractors are significantly different from the C2 of Soldiers and DA civilians. During detainee operations, Soldiers and DA civilians are under the C2 of the military chain of command. In an area of responsibility, the geographic combatant commander is responsible for accomplishing the mission and ensuring the safety of all U.S. armed forces, DA civilians, and contract employees in support of U.S. military operations. The supported combatant commander, through the Army Service component command, exercises C2 over Soldiers and DA civilians, including special recognitions and/or disciplinary actions. Military commanders do not, however, have the same authority over contractors and their employees. Military commanders have only management authority over contractors according to defense acquisition rules and regulations. The proper military oversight of contractors is imperative to fully integrate contractor support into the theater operational support structure.

C-12. It is important to understand that the terms and conditions of the contract establish the relationship between the military and the contractor. This relationship does not extend through the contract supervisor to the employees. Only the contractor can directly supervise the employees. The military chain of command exercises management control through the contract for the products and/or services provided. Contract employees will not be placed in a supervisory capacity over military or DA civilian personnel.

C-13. The military link to the contractor, through the terms and conditions of the contract, is the contracting officer or duly appointed contracting officer representative, who communicates specific needs to the contractor. The contracting officer, not the contracting officer representative, is the only government

official with the authority to direct the contractor or modify the contract. As indicated earlier, the contracting officer representative has daily contact with the contractor, is responsible for rigorous oversight and monitoring of contractor performance, and is key to contractor management and control. The contracting officer representative should be trained according to contracting regulations and policies and direction from the contracting officer. When possible, the contracting officer representative should be on-site where the contract is being performed.

INTERNATIONAL AGREEMENTS

C-14. International agreements and HN laws that apply to the operational area directly affect the use of contractors. They may establish legal obligations independent of contract provisions and may limit the full use of contractor support. Typically, these agreements and laws affect contractor support by—

- Directing the use of HN resources before contracting with external commercial firms.
- Placing restrictions on commercial firms to be contracted.
- Placing restrictions on the types of services to be contracted.
- Establishing legal obligations to the HN.
- Prohibiting contractor use altogether.

C-15. These agreements must be considered when preparing operation plans, operation orders, and contracts. The SJA within a commander's operational area can provide guidance on legal obligations.

POLICY

C-16. In the event of emergency or contingency operations, contractors are often required to perform services in the operational area. With the increased criticality of contractor support, especially when conducting I/R operations, the Army (AR 715-9) and DOD policies (DODI 3020.41) are that—

- Civilian contractors may be employed to support Army operations and/or weapon systems domestically or overseas. They will generally be assigned duties at echelons above division. However, they may be temporarily assigned or deployed anywhere, as needed and consistent with the terms of the contract and the tactical situation.
- The management and control of contractors depends on the terms and conditions of the contract.
- Contract employees are required to perform tasks identified within the statement of work and provisions defined in the contract. They will comply with applicable U.S. and international laws when contracted to perform detainee operations.
- Contract employees are subject to court-martial jurisdiction only in times of officially declared war or contingency operations. Non-HN contract employees supporting U.S. military forces may be prosecuted for serious criminal offenses under the Military Extraterritorial Jurisdiction Act. In all cases involving suspected contractor misconduct, commanders should immediately consult their SJA for specific legal advice.
- Contract employees deployed in support of I/R operations are provided with security and support services commensurate with those provided to DA civilians.
- Contract employees accompanying U.S. armed forces may be subject to hostile actions. If captured, a contract employee's status will depend on the type of conflict, applicability of relevant international agreements, and nature of the hostile force.

TRAINING CONSIDERATIONS FOR CONTRACTORS

C-17. Operations Iraqi Freedom and Enduring Freedom demonstrated that civilian contractors play a large role in sustainment and other operations in support of the maneuver commander. Contract interrogators are often used in detainee operations. A contract interrogator is a contractor who is specifically trained and DOD-certified according to DODD 3115.09 to collect information from HUMINT sources for the purpose of answering specific information requirements. Their operations must be conducted according to applicable U.S. laws, Geneva Conventions, and U.S. Army policies and regulations. Contract interrogators operate only in fixed facilities, not in tactical operations. (See DODD 3115.09 and DODI 3020.41.)

STATUS OF CONTRACT EMPLOYEES

C-18. According to Hague Convention, Article 13, “individuals who follow an army without directly belonging to it, such as newspaper correspondents and reporters, sutlers, and contractors, who fall into the enemy’s hands and whom the latter thinks expedient to detain, are entitled to be treated as prisoners of war, provided they are in possession of a certificate from the military authorities of the army which they were accompanying.”

C-19. Contract employees are not combatants or noncombatants. They are not subject to attack unless, and for such time as, they take a direct part in hostilities, which is prohibited by DOD policies. Contractors should, therefore, not be consciously placed in a position where they might be perceived as directly taking part in hostilities and, thereby, become subject to intentional attack. Commanders may unintentionally compromise the status of contractors by subjecting them to the following conditions:

- Being commanded or controlled by a published chain of command.
- Wearing a distinctive insignia or uniform.
- Carrying arms openly.

C-20. The employment and use of contractors must be carefully assessed by the commander to ensure that contract personnel are not placed in high-risk locations unnecessarily. Therefore, commanders must carefully consider decisions regarding the use or location of contract employees in the theater of operations. In some cases, a source of support other than contractors may be more appropriate. While some support functions (interrogators, interpreters, supplies and services) may be appropriately contracted, the direction and control of detention facilities for detainees in the operational area or a specific AO are inherently governmental and must be performed by military personnel. (See DODI 1100.22.)

CONTRACTOR SUPPORT FOR DETAINEE OPERATIONS

C-21. Contract employees have been used as HUMINT collectors in a variety of locations. Generally, these contract employees are former military HUMINT collectors (often former warrant officers or senior NCOs) with many years of experience. Occasionally, persons with other interrogation experience (law enforcement personnel) have been used. In many instances, contract employees deploy to assignments for a longer period of time than their military counterparts and offer a degree of continuity to the operation due to their longer service. Such use of contract employees in the detainee arena has proven to be highly successful. The key to this success lies in a clear understanding of the contract employee’s role within the supported unit’s overall mission and in understanding the contract employee’s responsibilities and limitations. (See FM 2-22.3 for more information on contracting HUMINT collectors.)

C-22. The statement of work outlines expectations of contract employees in terms of what the required output is, rather than how the work is accomplished. Generally, contract employees will follow local SOPs and policies that describe how military counterparts accomplish their day-to-day missions, though such SOPs and policies may make special provisions or exceptions for contract employees. Military commanders, officers in charges, NCOs in charge, and others who come in contact with contract employees in the course of their duties should familiarize themselves with the statement of work and applicable local policies and procedures so that they will be fully aware of the capabilities and limitations of contract employees.

C-23. Additionally, military personnel who interact with contract employees must be aware that only contractors manage, supervise, and give directions to their employees. Any questions or concerns as to a contract employee’s performance or conduct should be addressed to the appropriate contracting officer representative, who should then address such concerns to the contractor. SOPs and other local policies should clearly identify guidelines and procedures for addressing questions about contract employee performance and conduct.

C-24. The terms and conditions of any contract must include provisions that require contract employees to abide by guidance and obey instructions and general orders (including those issued by the theater commander) applicable to the U.S. armed forces and civilians. Operational support contracts must include requirements for the contractor to—

- Ensure that contract employees comply with the preceding guidance and demonstrate good conduct.
- Promptly resolve, to the satisfaction of the contracting officer representative, contract employee performance and conduct problems identified by the contracting officer representative.
- Remove and replace (at the contractor's expense) contract employees who fail to comply with the preceding guidance when directed by the contracting officer representative. This provides a significant tool to aid in achieving good order and discipline within the operational area or a specific AO.

JURISDICTION OVER CONTRACTORS

C-25. There are several ways that jurisdiction may be exercised over civilians and contractors. Determining whether criminal jurisdiction exists over contractors may depend on the type of contractor involved in misconduct and the applicable written provisions within the contract itself. Furthermore, civilians may be subject to the Military Extraterritorial Jurisdiction Act, which establishes federal jurisdiction over offenses committed OCONUS by persons employed by or accompanying the Armed Forces, or by members of the Armed Forces who are released or separated from active duty prior to being identified and prosecuted for committing such offenses, and for other purposes.

C-26. The commander has the authority to initiate proceedings that could lead to charges under UCMJ, possible HN jurisdiction under a Status of Forces Agreement, or violations of the Military Extraterritorial Jurisdiction Act (Public Law 106-523). Administrative discipline for civilians can include a reduction in grade, suspension from duty without pay, or removal from office. Military personnel may be subject to appropriate administrative discipline or to action under the UCMJ, which may include punishment under Article 15 or trial by court-martial. Government contractors may be held liable for their employee's misconduct. Contractor employees may also be held personally liable. In all cases involving suspected contractor misconduct, commanders should immediately consult their SJA for specific legal advice.

This page intentionally left blank.

Appendix D

Application of the Geneva Conventions to Internment and Resettlement Operations

The purpose of the law of war is to diminish the evils of war by regulating the conduct of hostilities. Various international agreements have been designed and adopted for the protection of individuals who are out of combat (hors de combat), including detainees and DCs interned and resettled in times of conflict. The Geneva Conventions are the primary sources of legal guidance for the care and treatment of these individuals. This appendix summarizes various provisions of the Geneva Conventions that are applied to I/R operations. The principal conventions are the GPW and GC. The Geneva Conventions speak in terms of *POWs* and *detained civilians*. When this appendix addresses the term *detainee*, it refers to all categories of detainees unless otherwise specified. The terminology of the Geneva Conventions is specific to prisoners of war without distinction to EPWs. The United States uses the term *EPW* to identify hostile forces taken captive and reserves the term *POW* to identify its own or multinational armed forces who have been taken captive. In this appendix, the term *POW* is used in the general sense of the Geneva Conventions.

Note. Soldiers conducting I/R operations should include a complete copy of the Geneva Conventions in their resource materials to use as a primary reference.

INTENT OF PROTECTION

D-1. DOD policy is to apply the Geneva Conventions in all military operations unless directed otherwise by competent authority, usually at the theater level or above (the same level of authority that designates hostile forces).

D-2. The GPW will be applied, presumptively, for persons who are detained because of their hostile acts, from the POC to a detention facility, until directed otherwise by competent authority (including the determination of status by an Article 5 tribunal). EPWs will be treated according to the GPW at times. The GC will be applied, presumptively, to other detainees (including those who are determined not to be EPWs) and DCs unless directed otherwise by competent authority. Current DOD policy requires that all detainees be afforded the protections outlined in Common Article 3 to the Geneva Conventions (see figure D-1, page D-2).

D-3. Although the protocols have not been ratified by the United States, many of their provisions are binding on the United States as customary international laws. Moreover, many U.S. allies are under a legal obligation (as parties to both protocols) to comply with these treaties. In addition to the conventions and protocols, AR 190-8 and DODD 2310.01E provide detailed guidance for the implementation of international agreements.

HUMANE TREATMENT

D-4. The minimum standard of treatment, dictated by DOD policy, is outlined in Common Article 3 to the Geneva Conventions.

Common Article 3 to the Geneva Conventions, 1949

In the case of armed conflict not of an international character occurring in the territory of one of the High Contracting Parties, each Party to the conflict shall be bound to apply, as a minimum, the following provisions:

(1) Persons taking no active part in hostilities, including members of armed forces who have laid down their arms and those placed hors de combat by sickness, wounds, detention, or any other cause, shall in all circumstances be treated humanely, without any adverse distinction founded on race, color, religion or faith, sex, birth or wealth, or any other similar criteria.

To this end, the following acts are and shall remain prohibited at any time and in any place whatsoever with respect to the above-mentioned persons:

- a. Violence to life and person, in particular murder of all kinds, mutilation, cruel treatment and torture;
- b. Taking of hostages;
- c. Outrages upon personal dignity, in particular humiliating and degrading treatment;
- d. The passing of sentences and the carrying out of executions without previous judgment pronounced by a regularly constituted court, affording all the judicial guarantees which are recognized as indispensable by civilized peoples.

(2) The wounded and sick shall be collected and cared for.

An impartial humanitarian body, such as the International Committee of the Red Cross, may offer its services to the Parties to the conflict.

The Parties to the conflict should further endeavor to bring into force, by means of special agreements, all or part of the other provisions of the present Convention.

The application of the preceding provisions shall not affect the legal status of the Parties to the conflict.

Figure D-1. Common Article 3 to the Geneva Conventions

Basic Standard of Care

D-5. The basic standard of care for all detainees is outlined in DODD 2310.01E. Detainees, regardless of their status or the circumstances of their capture, receive the basic standard of care from the POC until the end of their detention. This basic standard of care is summarized as follows:

- **Protect detainees (Articles 3 and 27, GC; Articles 3 and 13, GPW).** Detainees must be protected against violence and harm from external sources and sources within the detention facility.
- **Treat detainees humanely (Articles 3 and 27, GC; Articles 3 and 13, GPW) and show respect for their person (Articles 3 and 27, GC; Articles 3 and 14, GPW).** These two provisions are tied together and include respect for the detainee's religion, culture, family, sex, and race, among others.
- **Provide adequate food (Article 89, GC; Article 26, GPW).** Ensure that detainees are provided a nutritious diet that is sufficient in quality, quantity, and variety to keep them healthy. This diet should be consistent with local cultural diet if possible (for example, do not feed pork to Muslims). This does not include things like cookies, candy, and sweets; these items are luxuries

and may be provided as incentives. The common diet of detainees during the beginning of major combat operations can be stripped-down meals, ready-to-eat (the main meal and side dishes), but no sweets. Ensure that detainee rations are consistent with Soldier meals. For example, as a theater matures, conditions improve, and Soldiers and personnel operating the facility are provided three hot meals per day, then detainees should also be provided (three hot meals if possible) at least two hot meals and one cold meal per day.

- **Provide adequate water (Article 89, GC; Article 26, GPW).** Ensure that detainees have enough water to drink, wash with and, in some cases, do laundry. This does not include coffee, tea, or juice. Potable water should be at room temperature potable.
- **Provide adequate shelter (Article 85, GC; Article 25, GPW).** Ensure that detainees have shelter from the elements that is consistent with the level of shelter provided for Soldiers and personnel operating the facility. A hard-site shelter is not required, but protection from threats (mortars, rockets, improvised explosive devices) must be provided to protect detainees.
- **Provide adequate medical care (Article 91, GC; Article 30, GPW).** Ensure that detainees receive adequate medical and dental care that is consistent with the level of care provided for Soldiers and personnel operating the facility. Treatment can include mental health care, particularly with respect to suicidal detainees. Modern conflicts (focused on stability operations) do not result in the previously typical population of EPWs. Modern conflict result in detainees of all ages, both male and female. Special attention is required to address geriatric conditions, diabetes, self-inflicted injuries, and other unusual health conditions.
- **Provide sufficient clothing for the climate (Article 90, GC; Article 27, GPW).** EPWs who are captured while wearing military uniforms will be provided adequate clothing to replace their uniforms. Any person detained in civilian clothing must be provided clothing only if their clothing is inadequate or if the facility commander directs that jumpsuits or other uniforms be worn.
- **Provide adequate hygiene facilities (Article 85, GC; Article 29, GPW).** Detainees must be allowed to wash, shower, and brush their teeth regularly. They should be allowed to wash their clothes or be provided with clean clothes on a regular basis. To prevent health risks within the detention facility, ensure that detainees stay clean, using force if necessary.
- **Protect detainee property (Article 97, GC; Article 18, GPW).** If detainee property is taken (retained), it must be annotated on DA Form 4137 and a copy of the form given to the detainee as a receipt. When the detainee is released, he or she will be allowed to file a claim for anything that is missing. Evidence chain of custody is important, especially if the individual is to be prosecuted by U.S. or HN officials. Detainees are sometimes allowed to keep family pictures and are usually allowed to keep religious literature and paraphernalia. Refer to the local SOP for guidance.
- **Protect detainees from public curiosity (Article 27, GC; Article 13, GPW).** Tours of the facility will be allowed for official purposes only, and consistent with DOD policy. Photographs will be taken for official purposes only.
- **Allow detainees the freedom to exercise religion (Article 93, GC; Article 34, GPW).** At a basic level, detainees are allowed to practice religion, but are not necessarily facilitated in that practice. The practice of religion may be limited by the capturing unit based on security and operational considerations. For example, the exercise of religion might be curtailed when a call to prayer occurs shortly after a detainee is captured and is physically restrained. At that point, the detainee would not be allowed the freedom to exercise his religion.

Detainee Care at a Detention Facility

D-6. When detainees move back to a fixed facility, their treatment may change slightly based on their status and the rules in the facility. The following rights are not the only ones that detainees may be given at a fixed facility, nor will detainees necessarily be given all of these. The detention facility commander may determine that some limitations on these rights or benefits are justified for imperative reasons of security. However, as the theater matures, detention facilities improve, and more resources become available, all rights and benefits discussed below will be provided to detainees and DCs. They will—

- **Be allowed the freedom to exercise religion (Article 93, GC; Article 34, GPW).** Detainee freedom to exercise religion is broadened at this level and in fact, will not be restricted without a significant reason (such as a lockdown at the detention facility after a riot). At this level, the facility will typically facilitate the practice of religion by providing religious personnel to assist detainees or DCs or by providing necessary items (such as copies of the Qur'an, Bible, or other religious materials).
- **Be allowed to exercise (Article 9, GC; Article 38, GPW).** Detainees and DCs must be provided opportunities for physical exercise (to include sports and games) and outdoor time. Sufficient open spaces will be provided for these purposes in all facilities if available.
- **Be allowed to send and receive mail (Article 107, GC; Article 71, GPW).** Detainees must be allowed to send and receive mail unless the commander (usually the commanding general, three- or four-star in this context) determines that military necessity prevents it; and if so, it should be for a short period of time only. Detainees are allowed to send two letters and four postcards per month.
- **Be allowed representation (Article 102, GC; Article 79, GPW).** Detainees may elect a committee to represent them from within the facility. For EPWs, the representative will be the ranking EPW. EPW representatives are one method for detainees to advise the facility commander of complaints regarding detention conditions. In Muslim countries, when Imams and Sheiks are picked up and detained, they often fill the representative role simply because they are already leaders within the community. The same could be true for other religious leaders in other countries.
- **Not be photographed or videotaped for unofficial purposes (AR 190-8; Article 27, GC; Article 13, GPW).** Detainees may be photographed or videotaped for official purposes only. The restriction on unofficial photographs and videotapes also applies to detention facility personnel—photographs of the detention facility are not souvenirs. Videotape surveillance of the facility for security purposes is fine; however, the videotaping of interrogations is authorized on a case-by-case basis and according to DODD 3115.09. The key factor is that all photographs and videotapes must be for administrative, security, or intelligence/counterintelligence purposes.
- **Have access to the Geneva Conventions (in their own language) (Article 99, GC; Article 41, GPW).** Detainees have a right to a personal copy of the Geneva Conventions. The Geneva Conventions must also be posted in the facility in English and the detainee language. Copies will be supplied, upon request, to detainees who do not have access to posted copies.
- **Be allowed to complete documentation to notify their family of their location and that they are alive and in U.S. custody (Article 106, GC; Article 70, GPW).** DA Form 2665-R will be completed for EPWs; DA Form 2678-R (*Civilian Internee NATL-Internment Card*) will be used for CIs. Detainees must be allowed to complete these forms, which will be forwarded to their families.
- **Be issued an identification card (Article 97, GC; Articles 17 and 18, GPW).** EPWs will be issued a DA Form 2662-R; CIs will be issued a DA Form 2667-R (*Prisoner of War Mail [Letter]*). Detainees have the right to have an identification document. If they are military and the enemy military has an identification card system (similar to what the U.S. forces use), then they maintain their military identification card. If they are civilian and there is a civilian identification card (as there is in many countries), they will keep the civilian identification card. If they do not have an identification card, facility administration personnel must provide them with one.
- **Be allowed visits by the ICRC (Article 143, GC; Article 126, GPW).** Detainees have the right to visits by the ICRC. They also have the right to talk to the ICRC and voice their complaints.

D-7. The GPW and GC provide detailed guidance on procedures for the care of detainees and the use and maintenance of facilities. Some examples include procedures for the receipt of relief packages and money; treatment of personal property; provisions for EPWs, RP, and CIs to work; care of CI families; evacuation or transfer of detainees; and provisions of canteen facilities. These provisions of the Geneva Conventions are required to be implemented as soon as practicable after a detention facility is established. The detention facility commander may, if required by imperative military necessity, suspend all or part of the rights,

benefits, and provisions annotated in this section; the humane treatment standards can never be abridged. The specific provisions of the Geneva Conventions and the SJA should be consulted to aid in developing detailed SOPs and the specific suspension of these provisions.

INTERROGATION

D-8. A detaining power may interrogate EPWs. EPWs, however, are only required to provide their name, grade, birth date, and serial number. EPWs cannot be punished if they refuse to give additional information. Article 17 of the GPW states, “No physical or mental torture, nor any other form of coercion, may be inflicted on prisoners of war to secure from them information of any kind whatever. Prisoners of war who refuse to answer may not be threatened, insulted, or exposed to any unpleasant or disadvantageous treatment of any kind.” Similarly, Article 32 of the GC states, “No physical or moral coercion shall be exercised against protected persons, in particular to obtain information from them or from third parties.” All interrogation procedures in FM 2-22.3 are consistent with Common Article 3 to the Geneva Conventions, the Detainee Treatment Act of 2005, and U.S. domestic laws.

PROSECUTION

D-9. EPWs have “combatant immunity;” they cannot be tried or punished for their participation in an armed conflict. They may be prosecuted for committing war crimes, crimes against humanity, and common crimes under the laws of the detaining power or international laws. EPWs are entitled to be tried before the same courts and face the same procedures that detaining power military personnel would face (that is, the respective UCMJ for EPWs captured and held by U.S. forces). EPWs are entitled to representation by competent counsel during the trial and must be advised of the charges against them; they also have a right to appeal their conviction and sentence.

D-10. If, at the end of a conflict, an EPW has done nothing more than take up arms against opposing forces, the detaining power is required to repatriate the EPW. An EPW detained in connection with a criminal prosecution may also be repatriated if the detaining power consents.

D-11. Other detainees are not afforded the same extensive rights of trial as an EPW. These individuals may be tried by HN courts, international tribunals, or tribunals established by the detaining power. The trial rights they are afforded must, however, meet the minimum standards of Common Article 3 to the Geneva Conventions, which gives them judicial guarantees that are recognized as indispensable by civilized peoples. They—

- Must be informed of the charges against them.
- Are presumed innocent.
- Are allowed to—
 - Present their defense and call witnesses.
 - Be assisted by a qualified counsel of their choice.
 - Have an interpreter.
 - Be allowed to appeal the conviction and sentence.

TRIBUNALS

D-12. A tribunal is an administrative hearing, that is controlled by a board of officers. Article 5 tribunals determine the actual status of a detainee (CI, RP, or enemy combatant). A CI review tribunal determines the lawfulness of the internment of civilians who may be detained for security reasons. (See AR 190-8 for Article 5 tribunal procedures.)

ARTICLE 5 TRIBUNAL PROCEDURES

D-13. The following procedures are the minimum required for an Article 5 tribunal. Detainees whose status is to be determined—

- Will receive notice (in a language they understand) of the intent to hold a hearing.

- Will receive a fair opportunity to present evidence to the tribunal.
- Will be advised of their rights at the beginning of their hearings.
- Will receive a copy of the status determination and a notice (in a language they understand) of appeal rights.

D-14. After hearing testimony (if applicable) and reviewing documents and other evidence, the tribunal will determine the status of the detainee by majority vote in a closed session. The preponderance of evidence will be the standard used in reaching this determination. Hearsay evidence offered by the detainee or DOD may be accepted by the tribunal. There will be a rebuttable presumption in favor of creditable DOD evidence, with the burden shifting to the detainee to rebut that evidence with more persuasive evidence. A written report of the tribunal decision will be completed in each case. Possible board determinations are as follows:

- EPW (lawful enemy combatant).
- Recommended RP. This individual is entitled to EPW protection and may be considered for certification as a medical or religious RP.
- Civilian.
 - Civilian accompanying the force, given EPW status.
 - Innocent civilian who should be immediately returned to his home or released.
 - CIs, who for reasons of operations security, should be detained or transferred to local law enforcement authorities as appropriate.
 - Members of armed groups.

D-15. The following procedures may be added to the tribunal as time, resources, and circumstances permit:

- **Oath.** Members of the tribunal and the recorder may be sworn in. The recorder should be sworn in first by the tribunal president. The recorder may then administer the oath to all voting members of the tribunal, including the tribunal president.
- **Records.** A complete summarized record may be made of the proceedings. The recorder may prepare a record of the tribunal following the announcement of the tribunal decision. The record will then be forwarded to the first SJA in the internment facility chain of command.
- **Proceedings.** Open proceedings may be conducted, with the exception of deliberation, voting by the members, and testimony or other matters that might compromise security if held in the open.
- **Notification of classification.** Detainees may receive further notice of the factual basis for their classification.
- **Rebuttal.** Detainees may also receive a fair opportunity to rebut DOD factual assertions.
- **Attendance.** Detainees may be allowed to attend all open sessions and, if necessary, be provided an interpreter. Detainees may be excluded from sessions on the basis of national security.
- **Witnesses.** Detainees may be allowed to call witnesses, if reasonably available, and to question those witnesses called by the tribunal. Witnesses will not be considered reasonably available if, as determined by their commanders, their presence at a hearing would affect military operations. In these cases, written statements, preferably sworn, may be submitted and considered as evidence. All admissible evidence and statements may be excluded, as required, for national security. The recorder may also require additional witnesses when a doctor, chaplain, or other expert witness is required to determine RP status.
- **Right to testify.** Detainees may be given the right to testify or otherwise address the tribunal; they may not be compelled to testify before the tribunal.

D-16. The record of every tribunal proceeding that results in a determination denying EPW status will be reviewed for legal sufficiency when the record is received at the office of the SJA.

D-17. If a detainee requests an appeal, the decision of the board, any evidence admitted before the tribunal, and any additional information provided by the detainee will be presented to the convening authority within a reasonable time after the proceedings have concluded.

CIVILIAN INTERNEE REVIEW TRIBUNAL PROCEDURES

D-18. The following procedures are the minimum required for a CI review tribunal. This tribunal may be conducted as a result of an appeal to the initial order of internment or as part of the 6-month review required by the Geneva Convention Relative to the Protection of Civilian Persons (a review tribunal is mandatory for the six-month review). Detainees whose status is to be determined—

- Receive notice (in a language they understand) of the intent to hold a hearing.
- Receive a fair opportunity to present evidence to the tribunal.
- Are advised of their rights, if present, at the beginning of their hearings.
- Receive a copy of the status determination, along with a notice of further review rights, before final action by the convening authority.

D-19. Following the hearing of testimony (if applicable) and the review of documents and other evidence, the tribunal will determine the status of the detainee, in closed session, by majority vote. The preponderance of evidence will be the standard used in reaching this determination. Hearsay evidence offered by the detainee or DOD may be accepted by the tribunal. If the tribunal finds that there is an insufficient basis to deprive the CI of liberty or if the valid basis which necessitated internment no longer exists, the tribunal will recommend that the convening authority order the detainee's release from internment or placement. A written report of the tribunal's decision is completed in each case. Possible board determinations are as follows:

- Innocent civilian who should be immediately returned to his home or released.
- CI who for reasons of operational security should be detained or transferred to local law enforcement authorities as appropriate.

D-20. The internment of civilians is a significant deprivation of liberty that may solely be justified for imperative reasons of security. Accordingly, additional procedures may be appropriate, especially for periodic review proceedings. The following procedures may be added to the tribunal as time, resources, and circumstances permit:

- **Oath.** Members of the tribunal and the recorder may be sworn in. The recorder should be sworn in first by the president of the tribunal. The recorder may then administer the oath to all voting members of the tribunal, to include the president.
- **Records.** A complete summarized record may be made of the proceedings. The recorder may prepare a summarized record of the tribunal following the announcement of the tribunal's decision. The record will then be forwarded to the first SJA in the internment facility's chain of command.
- **Proceedings.** Open proceedings may be conducted, with the exception of deliberation, voting by the members, and testimony or other matters that might compromise security if held in the open.
- **Notice of classification.** Detainees may receive further notice of the factual basis for their classification.
- **Rebuttal.** Detainees may also receive a fair opportunity to rebut the DOD factual assertions.
- **Attendance.** Detainees may be allowed to attend all open sessions and be provided with an interpreter if necessary. Detainees may be excluded from sessions on the basis of national security.
- **Witnesses.** Detainees may be allowed to call witnesses, if reasonably available, and to question those witnesses called by the tribunal. Witnesses will not be considered reasonably available if, as determined by their commanders, their presence at a hearing would affect military operations. In these cases, written statements, preferably sworn, may be submitted and considered as evidence. All admissible evidence and statements may be excluded, as required, for national security. The recorder may also require additional witnesses.
- **Right to testify.** Detainees may be given a right to testify or otherwise address the tribunal; they may not be compelled to testify before the tribunal.

- **Representation.** CIs may also request a personal representative, or local civilian counsel. Such counsel will be at the expense of the detainee. No unreasonable delay in the proceeding will be permitted to obtain funding or otherwise engage the services of local counsel.

D-21. The record of every tribunal proceeding that results in a determination denying CIs liberty will be reviewed for legal sufficiency when the record is received at the office of the SJA.

D-22. A copy of the tribunal decision will be provided to the CI, along with a statement of further review rights (including the right to present a written response to the convening authority before his final decision).

D-23. The decision of the tribunal, evidence admitted before the tribunal, and any additional information provided by the detainee will be presented to the convening authority after the proceedings have concluded in order for the convening authority to make a final decision as to the status of the detainee.

Appendix E

Agencies Concerned With Internment and Resettlement Operations

This appendix provides background information about the various types of government and nongovernment agencies interested in I/R operations. The interests and support activities of these agencies include ensuring that proper and humane treatment is given to individuals, that the rights of others are protected, and that provisions for subsistence are present for individuals.

U.S. FEDERAL AGENCIES

E-1. The DOD, Department of Homeland Security, Federal Emergency Management Agency, and other federal agencies provide support for I/R operations. Often, there is more than one federal agency providing support for I/R operations. These federal agencies may support nongovernment agencies and/or private organizations in their I/R support roles.

DEPARTMENT OF DEFENSE

E-2. Under the provisions of the Geneva Conventions, the capturing power is responsible for the proper and humane treatment of I/R populations from the moment of capture. The OPMG is the primary headquarters for and the DA executive agency with responsibilities for detainee programs. In this role, it is responsible for developing policy and guidelines for sustainment support (including transportation and general engineering), subsistence, personnel, organizational forces, protective equipment and items consistent with the threat environment, mail collection and distribution, laundry facilities, and detainee wash facilities. The OPMG is also responsible for developing DA policies; collecting, accounting for, and disposing of captured enemy supplies and equipment through theater logistics and explosive ordnance disposal channels; and coordinating for personnel under U.S. control. U.S. Navy, Marine, and Air Force units that have detainees will turn them over to the U.S. Army at designated receiving points after initial classification and administrative processing. According to DODD 3025.1, the Secretary of the Army is the executive agent that tasks DOD components to plan for and commit DOD resources in response to civil authority requests from civil authorities for military support.

E-3. Examples of DOD decisionmakers for foreign I/R operations are the Under Secretary of Defense and the Deputy Assistant Secretary of the Army for Humanitarian and Refugee Affairs.

- Under Secretary of Defense who develops military policy for foreign humanitarian assistance, foreign relief operations, policy administration, and existing statutory programs.
- Deputy Assistant Secretary of the Army for Humanitarian and Refugee Affairs who executes DOD policy and tasks services accordingly.

DEPARTMENT OF HOMELAND SECURITY

E-4. In the event of a terrorist attack, natural disaster, or other large-scale emergency, the Department of Homeland Security is responsible for ensuring that emergency response professionals are prepared. This includes providing a coordinated, comprehensive federal response to any large-scale crisis and mounting a swift and effective recovery effort.

FEDERAL EMERGENCY MANAGEMENT AGENCY

E-5. The Federal Emergency Management Agency is responsible for leading the nation's emergency management system. Local and state programs are the heart of the nation's emergency management

system, with most disasters being handled by local and state governments. When devastation is serious and exceeds the capability and resources of local and state governments, states turn to the federal government for help. Once the President has declared a national disaster, Federal Emergency Management Agency coordinates with its own response activities and 28 other federal agencies that may provide assistance. Federal agencies help states and localities recover from disasters by providing services, resources, and personnel to perform necessary functions, such as transporting food and potable water to the affected area, assisting with medical aid and temporary housing for those whose homes are uninhabitable, and providing generators for electric power to keep hospitals and other essential facilities in operation. Federal Emergency Management Agency also works with states and territories during nondisaster periods to help plan for disasters, develop mitigation programs, and anticipate what will be needed when national disasters occur. The Federal Response Plan provides the foundation on which the Federal Emergency Management Agency executes its responsibilities.

E-6. Title 42, USC, Chapter 68, (Robert T. Stafford Relief and Emergency Assistance Act), authorizes the federal government to respond to disasters and emergencies to provide assistance; save lives; and protect public health, safety, and property.

E-7. Federal responses to natural disasters (earthquakes, hurricanes, typhoons, tornadoes, volcanic activity); man-made disasters (radiological, hazmat releases); and other incidents requiring federal assistance are also addressed in Title 42, USC.

E-8. The National Response Plan describes the basic mechanisms and structures by which the federal government mobilizes resources and conducts activities to augment state and local response efforts. To facilitate the provisions of federal assistance, the National Response Plan uses a functional approach to group the types of federal assistance that a state is most likely to need. Normally, a state needs no more than 12 emergency support functions. Each emergency support function is headed by a primary agency that has been selected based on its authorities, resources, and capabilities in the particular functional area. The 12 emergency support functions serve as the primary mechanism through which federal response assistance is provided to assist the state in meeting response requirements in an affected area. Federal assistance is provided to the affected state by coordinating with the Federal Coordinating Officer, who is appointed by the director of the Federal Emergency Management Agency on the President's behalf.

OTHER FEDERAL AGENCIES

E-9. Other federal agencies can provide advice and assistance in performing I/R operations. For example, the Department of Transportation has technical capabilities and expertise in public transportation and the Department of Agriculture has projects and activities ongoing in foreign countries and can provide technical assistance and expertise upon request. Other federal agencies that can be resourceful in planning and implementing I/R operations are the U.S. Agency for International Development, Office of Foreign Disaster Assistance, U.S. Information Agency, Department of Justice, Public Health Service, and ICE.

U.S. Agency for International Development

E-10. The U.S. Agency for International Development is not under direct control of the Department of State. However, it coordinates activities at the department and country level within the federal government.

Office of Foreign Disaster Assistance

E-11. The Office of Foreign Disaster Assistance is responsible for providing prompt nonmilitary assistance to alleviate the loss of life and suffering for foreign disaster victims. The Office of Foreign Disaster Assistance may request DOD assistance for I/R operations. Coordination and determination of forces required are normally accomplished through the DOD and joint task force.

U.S. Information Agency

E-12. U.S. Information Agency helps achieve U.S. objectives by influencing public attitudes overseas. The agency advises the U.S. government on the possible impact of policies, programs, and official statements

on foreign opinions. The U.S. Information Agency aids humanitarian assistance forces in gaining popular support and countering attempts to distort and frustrate U.S. or joint task force objectives.

Department of Justice

E-13. The Department of Justice agency that the U.S. armed forces may contact for assistance in domestic humanitarian assistance operations is the Community Relations Service. Under the authority and direction of the attorney general, the Community Relations Service provides on-site resolution assistance through a field staff of mediators and negotiators.

Public Health Service

E-14. The Public Health Service promotes the protection and advancement of the nation's physical and mental health. U.S. armed forces work with the Public Health Service during refugee operations in or near the United States and its territories.

U.S. Immigration and Customs Enforcement

E-15. The ICE provides information and service to the public while enforcing immigration control. The ICE is essential in the processing and eventual disposition of migrants and refugees in the United States and its territories.

UNITED NATIONS AGENCIES

E-16. The UN is involved in the entire spectrum of humanitarian assistance operations, from prevention to relief, ensuring that the rights and privileges of persons affected by I/R operations are observed.

UNITED NATIONS HIGH COMMISSIONER FOR REFUGEES

E-17. The UN High Commissioner for Refugees was established in 1951 as a subsidiary of the UN General Assembly; it has field offices in ninety countries. The UN High Commissioner for Refugees Handbook for Emergencies and other publications provide excellent guides for conducting refugee operations. The two main functions of the UN High Commissioner for Refugees are—

- Providing refugees with international protection that promotes the adoption of international standards for the treatment of refugees and supervises their implementation.
- Seeking permanent solutions for the refugee problem that facilitates the voluntary repatriation and reintegration of refugees into their country of origin or facilitates integration into a country of asylum or a third country.

E-18. Other activities of the UN High Commissioner for Refugees include emergency relief counseling, education, and legal assistance. In practice, these activities entail a very active role in human rights monitoring. In any case, the UN High Commissioner for Refugees role is to help governments meet the obligations that they have under various international statutes concerning refugees. (See chapter 1 for more information on the Convention Relating to the Status of Refugees and the Geneva Protocol Relating to the Status of Refugees, in which subscribing nations undertook to cooperate with and facilitate UN High Commissioner for Refugees tasks to provide international assistance and protection for refugees.)

UNITED NATIONS DISASTER RELIEF COORDINATOR

E-19. The UN disaster relief coordinator coordinates assistance for persons compelled to leave their homes because of disasters, natural or otherwise. Assistance includes items such as temporary housing and provisions for daily living subsistence.

RED CROSS AND RED CRESCENT MOVEMENT

E-20. Three main organizations compose the Red Cross and Red Crescent Societies. These organizations include the IFRC, the ICRC, and the International Federation of Red Crescent Societies.

INTERNATIONAL FEDERATION OF RED CROSS AND RED CRESCENT SOCIETIES

E-21. The IFRC and the International Federation of Red Crescent Societies carry out relief operations to assist victims of natural and manmade disasters. The IFRC and the International Federation of Red Crescent Societies have a unique network of national societies throughout the world that gives them their principal strengths. The IFRC is the umbrella organization for the ICRC and its network of national societies.

INTERNATIONAL COMMITTEE OF THE RED CROSS

E-22. The ICRC received its mandate to act as a monitoring agent for the proper treatment of detainees from the Geneva Conventions. The ICRC also coordinates international relief operations for victims of conflict, reports human rights violations, and promotes awareness of human rights and further development among nations of the National Red Cross and Red Crescent Societies.

E-23. Generally, a neutral state or an international humanitarian organization (such as the ICRC) is designated by the U.S. government as a protecting power to monitor whether detainees are receiving humane treatment as required by U.S. policy and international laws, including the Geneva Conventions. Duly accredited representatives of the protecting power, the ICRC, and others visit and inspect internment facilities and other places of internment in the discharge of their official duties. If the visit or assistance is within the limits of military and security considerations, the commander grants these organizations the necessary access to detainees and internment facilities. At times, the inspections will be previously authorized by the theater commander. Such visits will not be prohibited, nor will their duration or frequency be restricted, except for reasons of imperative military necessity and then only as a temporary measure. The detention facility commander, in consultation with the legal advisor, decides if this measure is required and immediately notifies higher headquarters and the ICRC/protecting power. Detention facility commanders, in consultation with the legal advisor, develop and foster relationships with ICRC personnel to address and resolve detainee issues, requests, or complaints.

E-24. If requested, these representatives may interview detainees without witnesses. Visiting representatives may not accept letters, paperwork, documents, or other articles for delivery from the detainee.

E-25. Detainees may make complaints or requests to the ICRC/protecting power regarding the conditions of their internment. Detainees may not be punished for making complaints, even if those complaints prove to be unfounded. Complaints will be received in confidence because they might endanger the safety of other detainees. Appropriate action, including segregation, will be taken to protect detainees when necessary.

E-26. Detainees exercising the right to complain to the detention facility commander or the ICRC/protecting power (according to AR 190-8) may do so—

- By mail.
- In person to the visiting representative of the ICRC/protecting power.
- Through an existing, officially constituted detainee committee or representative.

E-27. Internment facility commanders will attempt to resolve complaints and address requests. If a detainee is not satisfied with the way a commander handles a complaint or request, he or she may submit it in writing through the necessary channels to Headquarters, DA, OPMG, Attention: NDRC.

E-28. Written complaints to the ICRC/protecting power will be promptly forwarded to Headquarters, DA, OPMG, Attention: NDRC. A separate letter with detention facility commander comments will be included with the detainee complaint. Military endorsements will not be placed on detainee communication. Written communication from the ICRC/protecting power to a detention facility commander regarding a detainee complaint or request will be reported to Headquarters, Department of the Army, OPMG, Attention: NDRC, for inclusion in the detainee's personnel file.

E-29. ICRC inspectors make oral or written reports of their inspection findings or concerns at any command level. These reports are critically important to the chain of command and senior DOD leaders

and are immediately transmitted through command channels to the combatant commander. Oral reports are summarized in writing. The following must be included in the reports:

- A description of the ICRC visit or meeting, including the location, time, and date.
- A clear, concise summary of the reported observations.
- Corrective action initiated, if warranted.
- Identification of specific detainees, if applicable.
- Name of the ICRC representative.
- Name of the U.S. official who received the report.
- Name of the U.S. official who submitted the report.

E-30. All ICRC communications, including summarized reports, will be marked with the following statement: ICRC communications are provided to DOD as confidential, restricted-use documents. As such, these documents will be safeguarded the same as classified documents. The dissemination of ICRC communications outside DOD is not authorized without approval of the Secretary of Defense or Deputy Secretary of Defense.” While the ICRC has no enforcing authority and its reports are confidential, any public revelation regarding the standards of detainee treatment can have a substantial effect on international opinion.

This page intentionally left blank.

Appendix F

Sample Facility Inspection Checklist

While U.S. and international laws are important at all I/R levels, there is an increasing standard of requirements at internment facilities located at theater and strategic levels. Using a facility inspection checklist helps ensure that U.S. armed forces within and around the internment facility are operating according to established policy and U.S. and international laws. Figure F-1 is a sample facility inspection checklist that can be used to help develop an actual checklist for theater and strategic facilities. This sample checklist should be expanded to include more necessary details and tailored to meet the specific OE impacting the given internment site.

HOLDING FACILITY:		
DATE OF INSPECTION:		
FACILITY OIC:		
PERSONNEL PRESENT AT THE INSPECTION: _____		
FACILITY MANAGEMENT		
Facility SOP	Yes	No
Does a facility SOP exist?		
Is the facility SOP centrally located so that everyone can refer to it if necessary?		
Is the facility SOP current (for example, does it incorporate relevant FRAGOs as they are published)?		
Does the facility SOP fully implement requirements from the applicable DOD policies and include, as a minimum—		
• All physical security policies?		
• Guard and medic measures and/or procedures?		
• RUF?		
• In-processing procedures?		
• Accountability and detainee-tracking procedures?		
• Policies for processing DD Forms 2745?		
• Procedures for documenting, safeguarding, and returning detainee property according to the Geneva Conventions?		
• Procedures for accommodating NGOs and other similar organizations, such as the ICRC?		
• Procedures for reporting allegations of potential criminal acts or violations of the law of war?		
• Procedures for investigating and documenting detainee injuries or accidents?		
• Policies and warnings against exposing detainees to public curiosity or releasing photographs without legal review?		
• Procedures regarding the release or transfer of detainees?		
Has every facility employee read the SOP?		

Figure F-1. Sample internment facility inspection checklist

Appendix F

Inprocessing	Yes	No
Is there an interpreter on-site or on-call for in-processing?		
Are the legal status and rights of detainees written in their native languages and displayed in plain sight for them as they in-process?		
Is there an initial medical screening performed by a medic or doctor?		
Are photos taken to document any injuries?		
Are grievance procedures for detainees written in their native languages and displayed in plain sight?		
Outprocessing		
Is there an interpreter on-site or on-call for out-processing?		
Has the detainee participated in segregation and an out-briefing?		
Is there a medical screening performed by a medic or doctor?		
Is there a conditional release statement (for detainees being released)?		
Has the releasing unit prepared, maintained, and reported the chain of custody and transfer/release documentation according to current transfer and release procedures?		
HUMANE TREATMENT OF DETAINEES		
Hygiene	Yes	No
Do detainees have adequate washing facilities to keep them free from disease?		
Do detainees have blankets?		
Do detainees have mattresses or cots if available?		
Is the number of toilets equivalent to 1 for every 15 detainees?		
Do detainees have adequate and frequent access to toilets?		
Are adequate showers available in facilities that hold detainees more than 72 hours?		
Protection Measures (Indirect-/Direct-Fire Weapons)	Yes	No
Do detainees have heating, air-conditioning, ventilation, shade, and/or overhead cover?		
Are detainees sufficiently protected from the harm of current operations?		
Are detainees sufficiently protected from each other?		
Are women and juveniles segregated from the general detainee population if possible?		
Are armed guards of sufficient force to control access points and protect detainees from each other?		
Are procedures in place to protect detainees from the public, the press, and nonmilitary entities?		
Food	Yes	No
Are detainee diets adequate to keep them in good health?		
Are detainee diets culturally and religiously appropriate?		
Do detainees have access to potable water?		
Medical Support	Yes	No
Is daily sick call available?		
Are accommodations made for special needs; for example, sight-impaired or contagious detainees?		
Morale	Yes	No
Are detainees in long-term facilities permitted to correspond with family via the ICRC?		
Are detainees granted access to religious articles and permitted to pray?		
Are detainees in long-term facilities permitted exercise and/or recreation?		

Figure F-1. Sample internment facility inspection checklist (continued)

Sample Facility Inspection Checklist

Discipline	Yes	No
Are detainees provided copies of the Geneva Conventions in their native languages?		
Are facility rules and the disciplinary process written in detainee native languages and displayed in plain sight?		
Are employment and compensation procedures in place in long-term facilities as provided by relevant international laws and service policy?		
Are labor and/or finance records maintained if applicable?		
INTERROGATION/INTELLIGENCE COLLECTION	Yes	No
Do facility personnel ensure that capturing units completed DD Forms 2745 or their equivalent correctly when in-processing detainees?		
Do facility personnel seize, catalog, and safeguard the evidence, documenting from whom they took the property?		
Do facility personnel photograph evidence not suitable for storage or check to see if the capturing unit did?		
Is a military police guard designated to be responsible for detainee location during interrogations, particularly if the interrogations involve unconventional DOD forces or non-DOD agencies?		
Does a military police guard visually inspect the detainee after such interrogations, noting any bruises, cuts, or marks?		
Is a list of personnel qualified to interrogate detainees posted at the facility?		
Are interrogators qualified according to applicable MI and DOD regulations?		
Are there separate interrogation areas at the facility?		
Are interrogation areas sufficiently noncoercive; for example, are they well ventilated and well lit?		
Are interrogators using equipment or props during interrogations?		
Has the unit SJA reviewed and approved equipment used during interrogations?		
Is there a separate SOP for interrogators?		
Has the unit SJA reviewed and approved the interrogation SOP if it exists?		
Legend: DD Department of Defense DOD Department of Defense ICRC International Committee of the Red Cross MI military intelligence NGO nongovernmental organization OIC officer in charge RUF rules for the use of force SJA staff judge advocate SOP standing operating procedure		

Figure F-1. Sample internment facility inspection checklist (continued)

This page intentionally left blank.

Appendix G

Internment and Resettlement Forms

This appendix contains a table that identifies most of the forms used during detainee operations. The forms in table G-1 are required for I/R operations.

Table G-1. I/R forms

<i>Number</i>	<i>Title</i>	<i>Use</i>
DA Form 1124	<i>Individual Receipt Voucher Personal Deposit Fund</i>	Used as a receipt for a U.S. military prisoner's personal funds. (See DODI 7000.14-R.)
DA Form 1125-R	<i>Summary Receipt and Disbursement Voucher Personal Fund</i>	Used as a summary receipt of funds and checks issued. (See DODI 7000.14-R.)
DA Form 1128	<i>Petty Cash Voucher—Personal Deposit Fund</i>	Used as a record of petty cash funds to be charged against a U.S. military prisoner's personal funds account. (See DODI 7000.14-R.)
DA Form 1129-R	<i>Record of Prisoners' Personal Deposit Fund</i>	Used to record the balance of a prisoner's personal deposit fund.
DA Form 1134-R	<i>Request for Withdrawal of Personal Property</i>	Used to request the withdrawal of personal property.
DA Form 1135-R	<i>Personal Property Permit</i>	Used to show that prisoners are authorized to have the documented personal property in their cells.
DA Form 2662-R	<i>U.S. Army EPW Identity Card</i>	Issued to each detainee and carried at all times by that detainee.
DA Form 2663-R	<i>Fingerprint Card</i>	Used to collect fingerprints.
DA Form 2664-R	<i>Weight Register (Prisoner of War)</i>	Used to monitor the weight of each detainee.
DA Form 2665-R	<i>Capture Card for Prisoner of War</i>	Completed by each detainee upon capture and each time a detainee's address changes, such as when a detainee is moved to the hospital.
DA Form 2666-R	<i>Prisoner of War Notification of Address</i>	Used by detainees to notify their families of their present address. (See AR 190-8.)
DA Form 2667-R	<i>Prisoner of War Mail (Letter)</i>	Used by detainees to send letters to their families.
DA Form 2668	<i>Prisoner of War Mail (Post Card)</i>	Used by detainees to send post cards to their families.
DA Form 2669	<i>Certificate of Death</i>	Used to verify a detainee's death details surrounding the death to include the person caring for the detainee at the time of death and the status of the detainee's personal effects.
DA Form 2670-R	<i>Mixed Medical Commission Certificate for EPW</i>	Used by the Mixed Medical Commission to determine whether a detainee is eligible or ineligible for repatriation or hospitalization and to note the location of the examination who made the diagnosis.
DA Form 2671-R	<i>Certificate for Direct Repatriation for EPW</i>	Used to authorize direct repatriation and to note who authorized the action.
DA Form 2672-R	<i>Classification Questionnaire for Officer Retained Personnel</i>	Used to document personal and/or professional information on officer detainees for classification purposes.

Table G-1. I/R forms (continued)

Number	Title	Use
DA Form 2673-R	<i>Classification Questionnaire for Enlisted Retained Personnel</i>	Used to document personal and/or professional information on enlisted detainees for classification purposes.
DA Form 2674-R	<i>Enemy Prisoner of War/Civilian Internee Strength Report</i>	Used to identify the number of detainees (by specified categories) at a facility during a 24-hour period.
DA Form 2675-R	<i>Certification of Work Incurred Injury or Disability</i>	Used to substantiate an injury or disability that a detainee incurred through work details.
DA Form 2677-R	<i>U.S. Army Civilian Internee Identity Card</i>	Issued to each CI and carried at all times by that CI.
DA Form 2678-R	<i>Civilian Internee Natl-Internment Card</i>	Used by CIs to notify their families of their present address. (See AR 190-8.)
DA Form 2679-R	<i>Civilian Internee Letter</i>	Used by CIs to send letters to their families.
DA Form 2680-R	<i>Civilian Internee Natl-Post Card</i>	Used by CIs to send post cards to their families.
DA Form 2823	<i>Sworn Statement</i>	Used to record capture information.
DA Form 3078	<i>Personal Clothing Request</i>	Used to request the issue of personal clothing. (See AR 700-84.)
DA Form 3955	<i>Change of Address and Directory Card</i>	Used to notify relatives of a change in the address of a U.S. military prisoner.
DA Form 3997	<i>Military Police Desk Blotter</i>	Used to account for activities within the confinement facility for a 24-hour period.
DA Form 4137	<i>Evidence/Property Custody Document</i>	Used in an I/R facility to retain, account for, and track the custody of the personal property of I/R populations. (See AR 190-45 and AR 195-5.)
DA Form 4237-R	<i>Detainee Personnel Record</i>	Used to record personal information pertaining to a detainee and maintained by the unit that has custody of the detainee.
DA Form 5162-R	<i>Routine Food Establishment Inspection Report</i>	Used to rate and record the results of routine inspections on food service establishments.
DA Form 5456	<i>Water Point Inspection</i>	Used to record the results of inspections on water points and related equipment.
DA Form 5457	<i>Potable Water Container Inspection</i>	Used to record the results of inspections on water trailers and water tank trucks.
DA Form 5458	<i>Shower/Decontamination Point Inspection</i>	Used to record the results of inspections on shower/decontamination points, including water and associated equipment conditions.
DA Form 5513	<i>Key Control Register and Inventory</i>	Used to record the accountability of key control.
DD Form 2	<i>Armed Forces of the U.S. Geneva Convention Identification Card (Active)</i>	Used to identify individual U.S. military prisoners.
DD Form 499	<i>Prisoner's Mail and Correspondence Record</i>	Used to record all incoming and outgoing mail activity.
DD Form 503	<i>Medical Examiner's Report</i>	Used by a medical examiner to show the mental and physical status of U.S. military prisoners and their communicable disease status.
DD Form 504	<i>Request and Receipt for Health and Comfort Supplies</i>	Used by a prisoner to request health and comfort supplies.

Table G-1. I/R forms (continued)

Number	Title	Use
DD Form 506	<i>Daily Strength Record of Prisoners</i>	Used to record the number of prisoners at a facility during a 24-hour period.
DD Form 509	<i>Inspection Record of Prisoner in Segregation</i>	Used to record inspections (conducted every 15 to 30 minutes) on prisoners in segregation and to document the condition of the prisoner.
DD Form 515	<i>Roster of Prisoners</i>	Used to record the prisoners who are in custody.
DD Form 1131	<i>Cash Collection Voucher</i>	Used to impound U.S. currency and collect it; also used to exchange foreign currency to U.S. currency.
DD Form 2707	<i>Confinement Order</i>	Used to order the confinement of a U.S. military prisoner.
DD Form 2708	<i>Receipt for Inmate or Detained Person</i>	Used as a receipt for a detainee by a given individual and/or organization, such as the SJA.
DD Form 2710	<i>Inmate Background Summary</i>	Used to record the personal history of a U.S. military prisoner.
DD Form 2713	<i>Inmate Observation Report</i>	Used to report an observation of a prisoner.
DD Form 2714	<i>Inmate Disciplinary Report</i>	Used to report an incident and the discipline that followed it.
DD Form 2718	<i>Inmate's Release Order</i>	Used to order the release of a U.S. military prisoner.
DD Form 2745	<i>Enemy Prisoner of War (EPW) Capture Tag</i>	Used to record information on captured detainees, including the date and time of capture, name (if known), location of capture (grid coordinates), capturing unit, and circumstances of capture. It is a perforated, three-part form that has individual serial numbers.
<p>Legend:</p> <p>AR Army regulation CI civilian internee DA Department of the Army DD Department of Defense DODI Department of Defense instruction EPW enemy prisoner of war I/R internment and resettlement SJA staff judge advocate</p>		

This page intentionally left blank.

Appendix H

Use of Force and Riot Control Measures

The I/R facility commander provides guidance to the military police guard force on the appropriate use of force for protecting detainees, U.S. military prisoners, and DCs. This includes establishing uniform procedures that govern the use of force, weapons (lethal and nonlethal), and restraining devices. The I/R facility commander ensures that the quick-reaction force is organized and trained to respond to disturbances inside and outside the facility, whether it be from detainees, U.S. military prisoners, or DCs. Supporting military police units will train, at a minimum, squad- to platoon-size quick-reaction forces and squad-size elements for extraction and apprehension teams.

DEFINITIONS

H-1. The terms *use of force*, *serious bodily harm*, and *deadly force* have significant differences in their meanings. They are defined and/or described in the following paragraphs.

RULES FOR THE USE OF FORCE

H-2. Planning and preparing for the use of force is a necessary element in maintaining order. Commanders ensure that detainee facility security personnel are prepared for the effective use of force when necessary to protect themselves, other members of the force, or detainees. Commanders also ensure that the RUF continuum is applied when force is required to control detainees. Personnel assigned the mission of controlling detainees and providing security of the detention facility are issued and trained on the RUF specific to that mission. Theater ROE remain in effect for defending the detention facility from external threat. The RUF continuum is used in determining the appropriate amount of force needed to compel compliance. (See figure H-1, page H-2.) The use of deadly force against detainees is always considered a measure of last resort. Its use is authorized when no other means of suppressing the dangerous activity (attack, escape) is feasible. Furthermore, the use of deadly force is preceded by warnings appropriate to the circumstances. The continuum recognizes five basic categories:

- **Lethal.** Attempts to kill or inflict serious injury (using knives, clubs, objects, firearms).
- **Assaultive.** Attempts to attack or inflict injury (striking with hands or feet, biting).
- **Actively resistant.** Does not follow orders and offers physical resistance, but does not attempt to inflict harm (bracing or pulling away, attempting to flee).
- **Passively resistant.** Does not follow orders, but offers no physical resistance to attempts to gain control (going limp).
- **Compliant.** Offers no resistance to instruction and complies with directions.

H-3. The continuum also incorporates five levels of force. (See figure H-1) Ideally, the service member starts at Level 1 and progressively moves up the continuum until the detainee complies. However, the use of force is dictated by the actions of the subject during the encounter. Subject actions may escalate or deescalate rapidly, possibly skipping one or more levels. There is no requirement for the following levels of force to be applied in order:

- **Level 1: Cooperative controls.** Used to direct a compliant person (verbal direction, hand gestures).
- **Level 2: Soft controls.** Used when cooperative control fails and the level of force required escalates. They are designed with a low probability of causing injury (compliant or noncompliant escort positions, use of hand and/or leg restraints).

- **Level 3: Hard controls.** Used when escort positions fail and the level of force required escalates. They have a slightly greater possibility of causing injury (pressure points, joint locks, oleoresin capsicum spray [such as pepper spray], electronic stun devices).
- **Level 4: Defensive techniques.** Used when hard controls fail and the level of force required escalates. They also have a higher probability of causing injuries. (empty-hand strikes and blocks, baton strikes and blocks, NLWs, and MWDs).
- **Level 5: Deadly force.** Used as a last resort when all lesser means have failed or would be impractical. Used to prevent death or serious injury to self or others; to prevent the theft, damage or destruction of resources vital to national security or dangerous to others; or to terminate an active escape attempt (firearms and strikes with nonlethal weapons should be directed at vital points of the body).

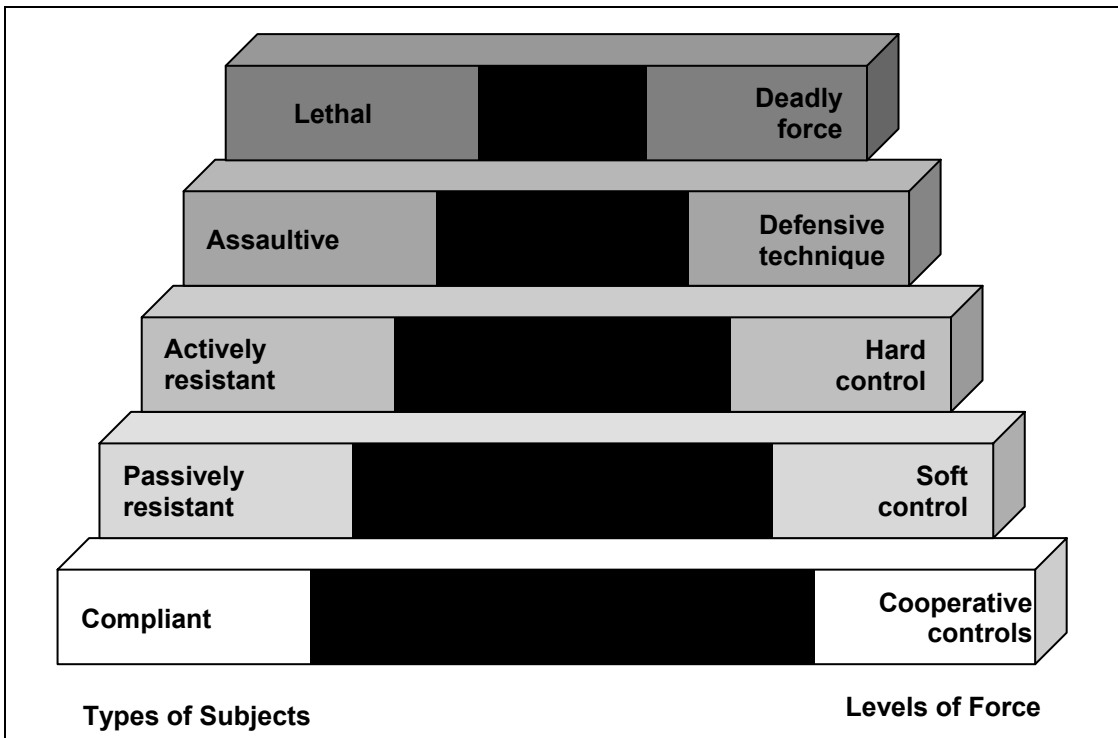

Figure H-1. Use-of-force continuum

H-4. When the use of force is necessary, it is exercised according to the priorities of force and limited to the minimum degree necessary. The use of deadly force is prescribed in AR 190-14. The combatant commander will establish the RUF with input from senior military police and SJA officers. The RUF predominantly apply inside a location where detainees are held. The ROE generally apply to combat operations (areas outside a facility). The application of any or all of the RUF listed below, or the application of a higher-numbered priority without first employing a lower numbered one depends on, and is consistent with, the situation encountered during any particular disorder.

H-5. The facility commander, in coordination with the higher echelon commander and the SJA, will designate representatives who are authorized the direct use of firearms and riot control agents in the event of a riot or other disturbance. The facility commander also sets forth guidelines for using these means in appropriate plans, orders, SOPs, and instructions. These guidelines specify the types of weapons to be used. The weapons do not have to be limited to the shotguns and pistols used for guarding prisoners.

H-6. Guard personnel will use the minimum amount of force necessary to reach their objective and carry out their duties according to the published criteria for the use of force. (See AR 190-14.)

SERIOUS BODILY HARM

H-7. Serious bodily harm is the amount of harm that causes serious injury to the body without causing death. It does not include minor injuries, such as a black eye or bloody nose, but does include fractured or dislocated bones, deep cuts, torn members of the body, serious damage to internal organs, and other life-threatening injuries.

DEADLY FORCE

H-8. Deadly force is a force that a person knows, or should know, would create a substantial risk of causing death or serious bodily harm. Deadly force is a destructive physical force directed against a person or persons by guards using a weapon or equipment which, when properly employed in its intended application, would inflict death or serious bodily harm. It is used only in extreme need and when all lesser means have failed or cannot reasonably be used. Deadly force, as described in AR 190-14, will only be used for—

- **Self-defense and the defense of others.** To protect military police Soldiers, other guards, or any other persons who reasonably believe themselves or others to be in imminent danger of death or serious bodily harm.
- **Incidents involving national security.** To prevent the actual theft or sabotage of assets vital to national security.
- **Incidents not involving national security, but inherently dangerous to others.** To prevent the actual theft or sabotage of resources, such as weapons or ammunition that are inherently dangerous to others.
- **Arrests or apprehensions.** To arrest, apprehend, or prevent the escape of a person when there is probable cause to believe that person has committed an offense of the nature specified in the preceding three bullets.
- **Serious offenses against persons.** To prevent the commission of a serious offense that involves violence and could cause death or serious bodily harm.
- **Escapes.** When deadly force has been specifically authorized by the head of a DOD component and reasonably appears necessary to prevent escape.

H-9. The facility commander is responsible for ensuring that all Soldiers understand the RUF (including the use of the command “Halt”); the use of deadly force; and the ban on the use of deadlines. According to AR 190-8, the facility commander must ensure that each detainee understands the meaning of the U.S. command “Halt.” When feasible, the use of deadly force should be preceded by warnings appropriate to the circumstances. Additionally, Article 42, GPW, requires warnings appropriate to the circumstances before the use of deadly force. When an individual attempts to escape, the guard will shout “Halt” three times. Thereafter, the guard will use the least amount of force necessary to halt the individual. If there is no other effective means of preventing escape, deadly force may be used.

H-10. In an attempted escape from a fenced enclosure, individuals will not be fired on unless they have cleared the outside fence or barrier (razor, concertina wire) and is making further efforts to escape.

H-11. Individuals attempting to escape outside a fenced enclosure will be fired on if they do not halt after the third command. An escape is considered successful if individuals—

- Reach the lines of the forces of which they are members or the allies of those powers.
- Leave the territory controlled by the United States or its allies.

RULES FOR THE USE OF FORCE

H-12. Facility commanders must balance the physical security of forces with mission accomplishment and the RUF issued for the I/R mission. Commanders and their staff, in concert with the SJA, develop the RUF. These rules are based on guidance from the President and/or Secretary of Defense; operational, political, diplomatic, and legal considerations; mission requirements; threat assessments; the law of war; and HN or third-country constraints on deployed forces. Commanders must clearly state their objectives with defined

operational limits. These limits must allow for mission accomplishment and the protection of deployed forces.

H-13. Restrictions on combat operations and the use of force must be clearly explained in the RUF and understood and obeyed at all levels. Soldiers must study and train in the RUF and discuss them for their mission. If Soldiers do not understand the RUF, their actions (no matter how minor) may have far-reaching repercussions, because friendly and enemy media can rapidly exploit any incident.

H-14. The RUF must address the specific distinctions between the various categories of I/R populations and the instruments of control available for each. The following issues should be used in developing these guidelines:

- Under what conditions will—
 - Deadly force be used?
 - Nonlethal technology be employed?

Note. The employment of NLWs must be clearly stated in the ROE.

- What will be the required warnings, if any, before nonlethal or lethal force is employed? (See AR 190-8 and AR 190-14.)

NONLETHAL WEAPONS

H-15. When drafting the RUF, it must be clearly articulated and understood that NLWs are an additional means of employing force for the particular purpose of limiting the probability of death or serious injury to noncombatants or belligerents. However, the use of deadly force must always remain an inherent right of individuals in instances when they, their fellow Soldiers, or personnel in their charge are threatened with death or serious bodily harm. NLWs add flexibility to the control of disturbances within the facility by providing an environment where guard forces can permissively engage threatening targets with limited risk of noncombatant casualties and collateral damage. (See FM 3-22.40.)

H-16. DOD defines NLWs as weapons that are explicitly designed and primarily employed to incapacitate personnel or material while minimizing fatalities, permanent injury to personnel, and damage to property and the environment. Unlike conventional weapons that destroy targets principally through blast, penetration, and fragmentation, NLWs employ means other than gross physical destruction to prevent the target from functioning.

H-17. The use of lethal force in self-defense or the defense of others, employed under the standing RUF, will never be denied. At no time will forces be deployed without the ability to defend themselves against a lethal threat nor will they forgo normal training, arming, and equipping for combat. Nonlethal options are a complement to, not a replacement for, lethal force. NLWs offer a way to expand the range of graduated responses across a variety of military operations. (See FM 3-22.40.)

H-18. The decision to use NLWs against individuals during a confrontation should be delegated to the lowest possible level, preferably to the platoon or squad. However, this requires that all personnel, not just leaders, have a clear understanding of the RUF and the commander's intent.

H-19. Commanders and public affairs officers must be prepared to address media questions and concerns regarding the use and role of NLWs. They must make it clear that the presence of NLWs in no way indicates abandoning the option to employ deadly force in appropriate circumstances.

ADVANTAGES OF EMPLOYING NONLETHAL WEAPONS

- H-20. The employment of NLWs provides a commander with alternatives to resolve a situation. They—
- Provide the commander with the flexibility to influence the situation favorably with a reduced risk of noncombatant fatalities and collateral damage.
 - Can be more humane and consistent with the political and social implications of humanitarian and peacekeeping missions.

- Allow the force that properly employs nonlethal options to gain advantages over those who rely on lethal options alone because the degree of provocation required to employ these options is substantially less. This advantage provides a more proactive posture, a quicker response, and a diminished likelihood of having a situation escalate to a point where deadly force is required to resolve a conflict within an I/R facility.
- Are less likely to provoke others (however, they may provoke a negative response).
- Diminish feelings of anger and remorse when deadly force is required after nonlethal options fail.
- Can facilitate postincident stabilization by reducing detainee alienation and collateral damage.
- Can reduce the possibility of injury to friendly forces when compared to forces without NLWs capabilities.

H-21. The NLW doctrine is designed to reinforce deterrence and expand the range of options available to facility commanders. They enhance the capability of U.S. armed forces to accomplish the following objectives:

- Discourage, delay, or prevent hostile actions.
- Limit escalation.
- Take military action in situations where the use of lethal force is not the preferred option.
- Better protect the U.S. armed forces.
- Temporarily disable equipment, facilities, and personnel.

H-22. Preventing fatalities or permanent injuries is not a requirement of NLWs. While complete avoidance of these effects is not guaranteed or expected, properly employed NLWs should significantly reduce them as compared with physically destroying the same target.

MILITARY POLICE NONLETHAL WEAPONS

H-23. Facility commanders should consider the use of force options discussed in this appendix and in AR 190-14 when handling disruptions within the facility. They are also encouraged by AR 190-14 to substitute nonlethal devices for firearms when they are considered adequate for military police to perform their duties safely. Military police currently have nonlethal options such as riot control agents (tear gas, pepper spray) and the military police club and riot baton for crowd control. There are other nonlethal devices being tested and fielded, and they should be available to I/R commanders.

H-24. If the United States is engaged in war, Executive Order 11850 governs the use of riot control agents. Presidential approval is required before riot control agents can be used, and they can only be used in defensive modes (riot control). If the United States is not engaged in war, the use of riot control agents is governed by CJCSI 3110.07A and approval authority may be lower than the President. If the use of riot control agents is desirable, leaders at any level must coordinate with the approving authority to ensure that their use is approved.

NONLETHAL WEAPONS TRAINING

H-25. Soldiers and their leaders must be trained in the correct employment of NLWs that are available to them. They must understand the limited use of these weapons in environments with restrictive RUF. Their training must be continuous at all levels to ensure that NLWs are properly employed and that leaders and Soldiers understand when and how to employ them effectively. Additionally, leaders and Soldiers must understand that the incorrect application of an NLW can have significant operational and political ramifications. Well-trained military police leaders who provide timely, clear guidance to military police Soldiers using NLWs will ensure mission accomplishment.

H-26. Many NLWs have maximum effectiveness and minimum safety ranges. Individuals who are struck short of the minimum safety range often suffer severe injuries or death, while the effects of most NLWs are greatly mitigated at longer ranges. To be effective, the threat must be engaged within the “effective” zone (beyond the minimum safety range and short of the maximum effective range).

H-27. When training with, and planning for, the use of NLWs—

- Never apply an NLW in a situation where deadly force is appropriate.
- Use only NLWs approved for use indoor use when indoors.
- Never apply an NLW in a situation where it will place troops in undue danger.
- Always cover an NLW with deadly force.

H-28. NLWs should be employed by Soldiers who are trained by Interservice Nonlethal Individual Weapons Instructor Course graduates. Units are not authorized to use a nonlethal capabilities set unless a course graduate is assigned/attached to the organization. Organizations that may be involved in future I/R operations should consider having their Soldiers trained at the course, which is taught at the U.S. Army Military Police School.

NONLETHAL WEAPONS TACTICS

H-29. DODD 3000.3 provides policy on the employment of NLWs. FM 3-22.40 provides an in-depth discussion on the tactics associated with NLWs employment.

RIOT CONTROL MEASURES

H-30. Some of the preliminaries involved when considering riot control measures are provided in the following paragraphs. Riot control agents, formations, and movements are covered extensively in FM 3-19.15.

H-31. All displays of conflict must be brought under control quickly. To maintain control, the facility commander must have a well-developed, well-rehearsed plan for defusing tense situations, handling unruly captives, and quelling riots. Only by quickly restoring order can the commander exercise effective control of the detainees. Due to the physical differences of I/R facilities, consider the following:

- Terrain features where the facility is located.
- Type of structures within the compound.
- Number of detainees within the compound.
- Size of the available control force.

H-32. Order must be restored using the least amount of force possible. Often, PSYOP resources can play an effective role in restoring order to the compound. If necessary, riot control agents and NLWs are authorized to incapacitate rioters.

PREPLANNING

H-33. Preplanning is the preparation conducted before a crisis occurs to improve reactions contain and neutralize the crisis successfully. The preplanning process includes training, developing plans, and gathering information and intelligence. At a minimum—

- Maintain updated drawings of the I/R compound.
- Identify potential threats from within the detainee population.

TRAINING

H-34. The quick-reaction force and associated teams must train on a regular basis in the five basic riot control formations. There also must be a continuous training program established to include, at a minimum, the following subjects:

- Principles of FM 27-10, specifically the provisions of the Geneva Conventions.
- Supervisory and human relations techniques.
- Methods of self-defense.
- Use of force.
- Riot baton use.
- M16 and M4 use with and without a bayonet.

- Areas of the body to avoid when using the riot baton, M16, or M4.
- Weapons familiarization and qualification.
- Public relations.
- First aid.
- Emergency plans.
- Compound regulations.
- Intelligence and counterintelligence techniques.
- Cultural customs, habits, and religious practices.
- Basic language of the detainees.
- Riot control agents employment and the various methods of dispersing them.
- NLWs employment.
- Bullhorn use.
- Restraint use.
- On-site medical support.

H-35. It is critical that personnel assigned or attached to internment facilities are oriented and specially trained in the custody and control of individuals. Each individual working within the compound must be fully cognizant of the provisions of the Geneva Conventions as they apply to the treatment of detainees and the Soldiers guarding the detainees.

PLANNING PROCESS

H-36. The planning process begins during preplanning. Once the quick-reaction force has been alerted of a riot situation, the leaders and quick-reaction force members further develop the preplans to fit the situation. (See FM 5-0.)

H-37. This part of the planning process is essential for the successful containment and neutralization of a riot. When using riot control agents, plans must be flexible enough to accommodate changes in the situation and weather. These plans must also consider the strict accountability and control of the employment of riot control agents. Riot control agents are employed only when the commander specifically authorizes their use and their use must be reported.

H-38. Other planning factors to consider are the cause, nature, and extent of the disturbance. Based on an analysis of these factors, the commander estimates the situation. The estimate must be as thorough as time permits. Using the estimate, the commander considers courses of action, selects riot control agents, and determines munitions needs. The main factors in choosing a course of action are—

- Desired effects.
- Demeanor and intent of the gathered detainees.
- Weather.
- Types of munitions available.

H-39. Plans must also address the security of riot control agents during storage, transportation, and employment. Wind direction, the size of the area, and the proximity of civilian communities may preclude the use of large quantities of riot control agents. In such cases, it may be necessary to use low concentrations to break a crowd into smaller groups.

H-40. When dealing with large riots, plans should indicate how the control force should channel and control individual movements in a specific direction, usually to an area where another force is waiting to receive, hold, and search them. Plans must contain information on how the riot control agents are employed to cover the target area with a cloud of sufficient strength to produce decisive results. Once the proper concentration is reached, the control force must maintain that concentration until the rioters are channeled into the predetermined area. When dispersers are used, the dispersal team maintains the concentration by moving the disperser along the release line at an even rate. They maintain the concentration by repeating the application as necessary.

H-41. Plans should also include serious incident reporting procedures. The record of events should be initiated to provide a basis for the preparation and submission of a formal serious incident report to higher headquarters. At a minimum, the following should be included:

- Time the incident was reported and by whom.
- Time the incident was reported to the commander.
- Time the quick-reaction force was alerted.
- Time the quick-reaction force commander reported to the affected compound.
- Time the quick-reaction force entered the compound.
- Weather conditions as they relate to the use of riot control agents.
- Number of U.S. armed forces injured or killed, including how they were injured or killed, and the medical attention given to them.
- Number of detainees injured or killed, including how they were injured or killed, and the medical attention given to them.
- Time the operation was completed and when the riot control force cleared the compound.

RIOT FORMATIONS

H-42. Quick-reaction force teams should be established with a minimum response time. Because of the physical nature of riot control, individuals in riot control formations should not carry rifles. Nonlethal attachments should follow closely behind the riot control formation. Lethal coverage must be provided for this entire formation. (See FM 3-22.40.)

DESIGNATED MARKSMEN

H-43. During a nonlethal engagement, the use of designated marksmen provides confidence and safety to those facing a riot. If a lethal threat is presented, the designated marksmen in overwatch positions (armed with appropriate sniper weapons mounted with high-powered scopes) can scan a crowd and identify agitators and riot leaders for apprehension and fire lethal rounds if warranted. Additionally, they are ideally suited for flank security and countersniper operations. (See FM 3-22.40.)

CROWD DYNAMICS

H-44. Commanders must be concerned with crowd control and the dynamics caused by disaffected people living in close quarters. Generally, the commander needs to be concerned about two types of disturbances: riots and disorders. I/R populations may organize disturbances of either type within the facility to wear down the guard force. (See FM 3-19.15.)

H-45. Simply being part of a crowd affects a person. To some extent, persons in a crowd are susceptible to actions different from their usual behavior. For example, crowds provide a sense of anonymity because they are large and often temporary congregations. Crowd members often feel that their moral responsibility has shifted from themselves to the crowd as a whole. Large numbers of people discourage individual behavior since the urge to imitate is strong in humans. People look to others for cues and disregard their own background and training. Only well-disciplined persons or persons with strong convictions can resist conforming to a crowd's behavior. Crowd behavior influences the actions of the disorderly participants and the authorities tasked to control them. Under normal circumstances, a crowd is orderly and does not present a problem to authorities. However, when crowd behavior violates laws or threatens life or property, a disturbance ensues.

CROWD BEHAVIOR

H-46. Social factors (leadership, moral attitudes, uniformity) may influence crowd behavior. Leadership has a profound effect on the intensity and direction of crowd behavior. When blocked from expressing its emotions in one direction, a crowd's frustration and hostility may be redirected elsewhere. The first person to give clear orders in an authoritative manner may become the leader. Agitators can exploit a crowd's mood and convert a group of frustrated, resentful people into a vengeful mob. Skillful agitators using

clandestine communications within the facility can reach large portions of the population and incite them to unlawful acts without having direct personal contact. In an I/R environment, any crowd can be a threat to law and order because it is open to manipulation.

H-47. Crowd behavior may be affected by emotional contagion or panic. Emotional contagion provides the crowd with psychological “unity.” The unity is usually temporary, but it may last long enough to push a crowd to mob action. When emotional contagion prevails, normal law and authority are suppressed, increasing the potential for violence.

H-48. Panic can occur during a disturbance when—

- Crowd members perceive their safety is at risk and attempt to flee the area.
- Crowd members cannot disperse quickly after exposure to riot control agents.
- Escape routes are limited, blocked, and/or congested.

H-49. Control force members are also susceptible to crowd behavior. They may become emotionally stimulated during a tense confrontation, and facility commanders must counteract this. The control force members must exercise restraint individually and collectively. Rigorous training, firm and effective leadership, and complete awareness and understanding of the RUF and ROI are necessary to offset the effect of crowd contagion upon the control force.

CROWD TACTICS

H-50. In disturbances, crowds employ any number of tactics to resist control or achieve their goals. Tactics may be unplanned or planned and nonviolent or violent. The more purposeful the disturbance, the more likely is the possibility of well-planned tactics.

Nonviolent Tactics (Disorders)

H-51. Nonviolent tactics may include name-calling, demonstrations, the refusal to work or eat, work slowdown, damage to or destruction of property, or barricade construction. Demonstrators may converse with control force members to distract them or to gain their sympathy. They may use verbal abuse such as obscene remarks, taunts, ridicules, and jeers. Crowd members want to anger and demoralize the opposition. They want authorities to take actions that later may be exploited as acts of brutality.

H-52. In compounds where women, children, and the elderly are interned, they may be placed in the front ranks of the demonstration to try to discourage countermeasures by the control force. When countermeasures are taken, agitators may try to stir public displeasure and embarrass the control force through the media. Individuals may form human blockades to impede movement by sitting down in the footpaths or entrances to buildings within the compound. This may disrupt normal activity, forcing control personnel to remove demonstrators physically. Individuals may lock arms, making it hard for the control force to separate and remove them, which makes the control force seem to be using excessive force.

H-53. Some nonviolent tactics are further described as follows:

- **Demonstrations.** Demonstrations are the actions of groups of people whose behavior, while not violent, conflicts with those in authority. They are characterized by unruliness and vocal expressiveness without violence. Demonstrations may be organized in celebration of national holidays; as protests against food, clothing, living conditions, or treatment; or for other similar factors.
- **Refusal to work or eat.** Individuals may refuse to work or eat (collectively or individually) as a means of harassing the detaining power or in an attempt to gain concessions from the detaining power. Prompt isolation and segregation of such offenders and their ringleaders normally control this type of disorder.
- **Work slowdown.** Individuals may initiate a deliberate work slowdown to delay the completion of work projects, thereby harassing the detaining power. Disorders of this nature can be controlled in the same manner as the refusal to work or eat.

- **Damage or destruction of property.** Individuals often damage or destroy property to harass the detaining power or to impede or prevent normal operations of the facility. This type of disorder can be controlled by identifying, isolating, and segregating individuals involved.

H-54. Unorganized disorders are characterized as being spontaneous in nature. They begin because of the actions of a single individual. Like all disturbances, their prompt control is essential.

Violent Tactics

H-55. Violent crowd tactics may be extremely destructive. They may include physical attacks on fellow detainees, guards, or government property; fires; or bombings for the purpose of an escape, a grievance protest, or tactical or political advantages. Only the attitudes and ingenuity of crowd members, the training of their leaders, and the materials available to them limit their use of violent tactics. Rioters may commit violence with crude, homemade weapons or whatever items are at hand (rocks, bricks, bottles). If violence is planned, rioters may easily conceal makeshift weapons or tools for vandalism.

H-56. Rioters may erect barricades to impede movement or to prevent a control force from entering certain areas or buildings. They may use vehicles, trees, furniture, fences, or other handy materials to erect barricades. In an effort to breach barriers, rioters may throw grapples into wire barricades and drag them down. They may use grapples, chains, wire, or rope to pull down gates or fences to affect a mass escape. They may use long poles or homemade spears (tent poles) to keep control forces back while they remove barricades or to prevent control forces from using bayonets.

H-57. Rioters can be expected to vent their emotions on individuals, troop formations, and control force equipment. They may throw rotten fruits or vegetables, rocks, bricks, bottles, improvised bombs, or any other objects at hand.

H-58. Rioters may direct dangerous objects like vehicles, carts, barrels, or liquids (such as boiling water, oil, or urine) at troops located on or at the bottom of a slope. On level ground, they may drive commandeered vehicles at the troops, jumping out before the vehicles reach the target to breach roadblocks and barricades, and scatter the control force formation.

H-59. Rioters may set fire to buildings or vehicles to block the advance of the control force formation. Fires may also be set to create confusion or diversion, destroy property, or to mask escapes.

H-60. Riots are organized or unorganized. In organized riots, leaders of detainees may reorganize the detainee population into quasimilitary groups. These groups are capable of developing plans and tactics for riots and disorders. Riots could be instigated for—

- **An escape.** Detainee leaders organize a riot as a diversion for an escape attempt. The attempt may be for selected individuals, small groups, or a large mass of individuals.
- **A grievance protest.** Grievance protests could be organized as a riot. Under normal circumstances, a riot of this type will not be of an extremely violent nature. It may turn violent when the leaders attempt to exploit any successes of the riot or weaknesses of the detaining powers.
- **Tactical purposes.** Riots are often organized for the sole purpose of causing the detaining power to divert troops. This tactical move limits the detaining power's ability to perform its mission.
- **Political purposes.** Riots are often organized as a means of embarrassing the detaining powers in their relations with the protecting powers and other nations or for use as propaganda by the nations whose nationals are involved in the riot. They may also be organized as a means of intimidating individuals or groups that may have been cooperative with the detaining power.

H-61. Unorganized riots are characterized at their inception as being spontaneous in nature, although they could be exploited and diverted by leaders at any subsequent stage of the riot into a different type. Crowds may start as a holiday celebration, a group singing, a religious gathering, an arson event, or any other type of gathering that might lead to group hysteria. Under determined leadership, the pattern of these gatherings could change to that of an organized riot.

Appendix I

Medical Support to Detainee Operations

As participants in the Geneva Conventions, detainees in U.S. custody receive medical care consistent with the standard of medical care that applies to U.S. armed forces in the same area. (See AR 40-400, AR 190-8, DODD 2310.01E, DODD 2311.01E, the FM 4-02 series, FM 8-10-6, and FM 27-10.)

MEDICAL AND ETHICAL CONSIDERATIONS OF THE TREATMENT OF DETAINEES

I-1. Medical personnel are well trained in, and guided by, the ethics of their professional calling. These training and ethical principles, coupled with the requirements of international laws as they pertain to the treatment of detainees during a conflict, ensure the ethical treatment of all sick and wounded personnel.

Note. See Military Medical Ethics Volume I and Volume II for more medical information. These manuals are available electronically at <<http://www.bordeninstitute.army.mil>>.

PROHIBITED ACTS

I-2. The Geneva Conventions specifically prohibit certain acts and specify that all detainees will receive humane treatment. Prohibited acts include murder, torture, medical and scientific experimentation, physical mutilation, and the removal of tissues and organs for transplantation. Additionally, causing serious injury, pain, or suffering is prohibited.

I-3. Torture can take many guises in wartime situations. Historically, it has been used to extract tactical information from an uncooperative detainee. However, it has also been applied to punish and/or inflict pain and suffering. Regardless of the rationale, the torture of detainees is prohibited. Medical personnel do not participate in the torture of detainees, to include—

- Administering drugs to facilitate interrogation.
- Designing psychological strategies for interrogators.
- Advising interrogators on the ability of a detainee to withstand torture.

I-4. The detaining power is prohibited from conducting medical and scientific experimentation on detainees. This prohibition arose from experiences in World War II. Since the prisoner is in the custody of the detaining power, any consent to the experiment is suspect as the prisoner may feel coerced to provide consent. This prohibition does not extend to the introduction of new treatment regimens and/or pharmaceuticals when there is a substantiated medical necessity and withholding the treatment would be detrimental to the health of the detainee.

I-5. Due to the nature of warfare, numerous combatants and/or noncombatants may sustain injuries that require the amputation of an unsalvageable limb to save their life. Amputation that is based on a medical necessity and conforms to existing standards of medical care is not considered physical mutilation and, therefore, is permitted.

I-6. With advances in medical science, transplanting organs in peacetime has become an accepted method of treatment for certain conditions. However, during wartime, with the exception of blood and skin grafts, organ transplants are prohibited. Although the recipient's health status benefits from the transplant, the donor's health status does not. As with the discussion of consent for medical experimentation, the consent of donors in the custody of the detaining power is suspect as donors may feel coerced by their status into providing consent. Transplanting organs and/or tissue from cadavers is also prohibited as the practice could

lead to allegations that donors were permitted to die to harvest their organs. Geneva Protocol I does permit the exception of blood and skin grafts but provides stringent controls. Tissues obtained must be used for medical purposes, not research or experimentation. The tissue donor must voluntarily consent to the procedure, and records must be maintained.

I-7. Geneva Protocol I reiterates the right of an individual to refuse a surgical procedure, even if that procedure would be lifesaving and falls within existing medical standards. A surgeon may not feel ethically bound by a refusal in the case of a minor or an individual whose judgment is impaired by injury or illness. Documenting the issue, whether it is the patient's refusal (in writing, if possible) or the surgeon's decision is an essential step in ensuring that allegations of abuse are not forthcoming.

SUSPECTED OR ALLEGED ABUSE, TORTURE, OR SEXUAL ASSAULT

I-8. Medical personnel are obligated to report any suspected and/or alleged abuse, torture, or sexual assault through the chain of command and to the U.S. Army Criminal Investigation Command. Medical personnel report any suspected abuse and/or torture through technical channels to the detainee operations medical director. Medical personnel are also required to document actual, alleged, or suspected abuse in the detainee's medical record.

I-9. Medical personnel have contact with detainees in a variety of settings. Medical personnel must document any suspicious medical occurrences during—

- **Initial detainee screening.** Preexisting medical conditions, wounds, fractures, and bruises should be noted. The documentation of these injuries and conditions provides a baseline for each detainee and facilitates the identification of injuries that may have occurred in the internment facility.
- **Routine detainee sick calls.** Detainees should be visually examined to determine if unusual or suspicious injuries are apparent. If any are present, the health care provider must attempt to determine from the detainee how the injuries occurred. Any injuries that cannot be explained, or for which the detainee is providing evasive responses, are noted in the medical record and reported to the chain of command and functional medical channels.
- **Facility visits.** The reasons for entering the detention facility may include conducting sanitary inspections, providing emergency medical care, and dispensing medications. When in the facility, medical personnel must be observant. They must immediately report to the chain of command anything which might indicate that detainees are being mistreated. If they observe a detainee being mistreated, they must take immediate action to stop the abuse and then report the incident.

I-10. If a detainee alleges that abuse, torture, or sexual assault has occurred, the health care provider must report the allegations to the facility commander, CID, and detainee operations medical director. Medical personnel are not required to investigate the allegation beyond what is required to render appropriate medical treatment, except in the cases of alleged rape and/or sexual assault. Cases of alleged rape and/or sexual assault require that medical personnel comply with the standard procedures for the collection, preservation, and processing of rape kit evidence. Detainees alleging sexual assault or rape will be tested for sexually transmitted diseases, and female detainees will be given a pregnancy test as specified in the theater policy.

MEDICAL SUPPORT PROVIDED TO INTERROGATION TEAMS

I-11. Under the provisions of the Geneva Conventions, medical personnel are prohibited from engaging in acts that are considered harmful to detainees. Medical personnel providing direct patient care for detainees will not participate in, or provide medical information to, interrogators. Medical personnel are—

- Authorized to halt any interrogation or interrogation technique if the detainee's health or welfare is endangered.
- Authorized to stop an interrogation immediately if a detainee requires any medical treatment during the interrogation.
- Authorized to perform preinterrogation and/or postinterrogation medical evaluations at their discretion.
- Required to perform preinterrogation and/or postinterrogation medical evaluations on the request of an interrogator.
- Required to document preinterrogation, during interrogation, and postinterrogation medical care in detainees' medical records.
- Required to develop procedures for documenting medical care delivered during or due to an interrogation.

I-12. Behavioral science consultation team members are authorized to make psychological assessments of the character, personality, social interactions, and other behavioral characteristics of interrogation subjects and to advise authorized personnel performing lawful interrogations. Those who provide such advice may not provide medical care for detainees, except in emergencies.

I-13. Medical personnel must consider the welfare of their patients. If a detainee has a medical condition that could deteriorate during interrogation and result in a health crisis for the detainee, the health care provider should inform the interrogation team of the existing medical limitations. For example, a detainee who is diabetic may have dietary restrictions and requirements and a need to take medications on a scheduled basis.

MEDICAL PERSONNEL

I-14. The roles and responsibilities of medical personnel associated with detainees vary. The following paragraphs describe those personnel and their activities.

DETAINEE OPERATIONS MEDICAL DIRECTOR

I-15. The theater Army Surgeon for the Army Service component command appoints a detainee operations medical director to oversee and guide all elements of health care delivery to detainees within the theater. This ensures a comprehensive, continuous assessment of critical mission tasks; facilitates the rapid identification of deficiencies; and enhances the timely resolution of health care delivery issues.

I-16. The detainee operations medical director is responsible for—

- Advising the theater commander on the health of detainees.
- Providing guidance, in conjunction with the command SJA, on the ethical and legal aspects of providing medical care to detainees.
- Recommending the task organization of medical resources to satisfy mission requirements.
- Recommending policies concerning medical support to detainee operations.
- Developing, coordinating, and synchronizing health consultation services for detainees.
- Evaluating and interpreting medical statistical data.
- Recommending policies and determining requirements and priorities for medical logistics operations in support of detainee health care. This includes blood and blood products, medical supply and resupply, formulary development, medical equipment, medical equipment maintenance and repair services, optometric support, fabrication of single-vision and multivision optical lenses, and spectacle fabrication and repair.
- Recommending medical evacuation policies and procedures and monitoring medical evacuation support to detainees.
- Recommending policies, protocols, and procedures pertaining to the medical and dental treatment of detainees. These policies, protocols, and procedures provide the same standard of care provided to U.S. armed forces in the same area.

- Ensuring that medical records are maintained on each detainee according to AR 40-66 and AR 40-400.
- Ensuring that monthly weigh-ins are conducted and reported as required by regulation and international laws.
- Planning for and implementing preventive medicine operations and facilitating health risk communications (to include preventive medicine programs to counter the medical threat).

MEDICAL PERSONNEL ORGANIC TO MILITARY POLICE UNITS

I-17. The military police battalion has organic medical personnel to provide limited Level I medical care capability and preventive medicine services within the internment facility. When a detainee operations medical director has been designated within the joint operations area, these medical personnel are under the technical guidance of the detainee operations medical director.

I-18. These medical personnel assist with in-processing detainees by providing the initial medical examination. They provide routine sick call services and emergency medical treatment and coordinate with the supporting medical units for Level II and above care. They maintain medical records, to include DA Form 2664-R. When the supporting medical unit is colocated with the internment facility, the unit scope of practice, schedule, and duty assignments are coordinated through the supporting medical unit.

MEDICAL PERSONNEL ORGANIC TO MANEUVER UNITS

I-19. Medical personnel organic to maneuver units may be required to provide emergency medical treatment, area medical support, and medical evacuation at the POC and to temporary concentrations of detainees at DCPs and DHAs. In early-entry operations, the senior medical officer (brigade surgeon) serves as the detainee operations medical director until follow-on forces are deployed and a detainee operations medical director is designated for the joint operations area.

MEDICAL PERSONNEL ORGANIC TO SUPPORTING MEDICAL UNITS

I-20. The medical resources required to support detainee operations are task-organized based on the mission variables. The detainee operations medical director determines the medical support requirements and develops and provides technical guidance for all medical resources engaged in detainee medical operations. This guidance is directed to appropriate medical personnel through their technical channels.

I-21. The detainee operations medical director is designated by the medical deployment support command commander to develop and provide technical guidance on the medical aspects of detainee operations conducted throughout the joint operations area. Technical guidance is exercised throughout all echelons of medical channels and affects all medical personnel and units delivering health care to detainees. Technical guidance encompasses—

- Medical services provided at DCPs and DHAs, to include limited medical screening, emergency medical treatment, preventive medicine measures (hygiene and sanitation), and the medical evacuation of seriously injured or ill detainees through medical channels. The echelon commander must provide guards and/or escorts when detainees are evacuated through medical channels; medical personnel cannot perform guard functions.
- Medical services provided in the internment facility, to include—
 - Initial medical examinations.
 - Medical treatment (routine care, sick call, emergency services, hospitalization, medical consultation, and specialty care requirements).
 - Medical evacuation.
 - Preventive medicine (medical surveillance, occupational and environmental health surveillance, hygiene and sanitation standards and practices, pest management activities, water potability, dining facility and services hygiene, food preparation practices).
 - Dental services.

- Veterinary support (food inspection and quality assurance, veterinary preventive medicine, animal medical care).
- Mental health care.
- Neuropsychiatric treatment and stress prevention as required.
- Medical logistics (medical supplies, pharmaceuticals, medical equipment and medical equipment maintenance and repair, blood management, optical lens fabrication).
- Medical laboratory support.
- Medical services provided in U.S. military medical treatment facilities that are not part of established internment facilities. This can include emergency medical treatment provided at battalion aid stations and Level II medical treatment facilities (medical companies) and forward resuscitative surgery provided by forward surgical teams to stabilize the patient for further evacuation and hospitalization.
- Medical administrative matters such as the establishment and maintenance of medical records, documentation of preexisting injuries (to include medical photography if deemed appropriate), restrictions on activities based on medical conditions (similar to medical profiles), and documentation required for legal purposes (monthly height and weight records).
- Procedural guides and SOPs that are developed and disseminated for reporting suspected detainee abuse. Medical personnel are trained on procedures and ethical considerations.
- Procedural guides and SOPs that are developed to standardize the credentialing of health care providers, to define the scope of practice of medical personnel, and to establish the scope of practice for retained medical personnel.
- Standards of medical care throughout internment facilities within the joint operations area that are established, inspected, and enforced (the standards used are the same as those for U.S. armed forces).
- Procedures that are established and disseminated for identifying, reporting, and resolving medical ethics and other legal issues.
- Procedures that are established for ensuring medical proficiencies and competencies, identifying deficiencies, and providing required training to resolve deficiencies.
- Programs of instruction that are developed to ensure that all medical personnel engaged in detainee health care have appropriate orientation and training in the detainee's culture, language (and/or linguist support), social order, and religion.

CULTURAL CONSIDERATIONS

I-22. As part of their predeployment activities, personnel participating in multinational operations normally receive an orientation in the culture, languages, and religious beliefs prevalent in the operational area. Medical personnel must ensure that they understand the medical considerations presented by these customs and beliefs. Cultural or religious norms may affect a patient's compliance with a prescribed medical regimen, may prohibit the use of blood and blood products, or may restrict the use of certain food products, thereby affecting the patient's nutritional status.

I-23. U.S. armed forces involved in multinational operations will normally require interpreter support. This is of particular importance for medical personnel as they interact with multinational forces and treat detainees. Medical personnel must be able to discuss a patient's medical history and to understand the signs and symptoms being described. Medical personnel may consider using—

- **Flash cards.** During recent operations, some medical units devised flash cards which pictorially depicted a variety of medical complaints. Units developing this type of communications tool must be cautious and ensure that the images used do not offend the cultural or religious beliefs of the individual. Commercial products may also be available.
- **Retained medical personnel.** The number of individuals capable of fulfilling interpreter requirements may be limited. In detainee operations, retained medical personnel may be able to assist in relating the patient's medical condition to the health care provider.

- **Advanced technology.** Health care providers may be able to leverage advances in communications technology that can provide an automated interpreter service through a handheld device.

SECURITY CONSIDERATIONS FOR MEDICAL PERSONNEL, MEDICAL EQUIPMENT, AND SUPPLY ITEMS

I-24. Level II medical treatment facilities provide support on an area basis. DCPs and DHAs may have to coordinate emergency medical care from Level II medical facilities for temporary concentrations of detainees being held. If this is necessary, consider the following:

- Security measures instituted at these points are dictated by the unit that established the DCP. Medical personnel should not enter the DHA until necessary security precautions have been taken.
- Medical personnel should inventory medical supplies (especially sharps items, such as needles) and equipment that they are taking into the enclosure. While in the enclosure, medical personnel must be alert and prepared to defend themselves if the need arises. Before medical personnel leave the enclosure, they must account for and remove all medical supplies, equipment, and medical waste.

I-25. At internment facilities, medical personnel should observe the same precautions as they would at a DCP or a DHA. The military police unit that establishes the facility dictates what security procedures will be observed when treating detainees at the facility. Medical personnel should never enter the general population area by themselves. When possible, have the detainees taken to the established medical treatment area rather than have medical personnel enter confinement areas. The medical treatment area should have all medical supplies (especially sharp items), medical equipment, and pharmaceuticals secured before permitting the detainees to enter. Medical personnel must remain alert continuously while in the presence of detainees. Although medical personnel may treat the same detainee for a recurring or chronic condition and feel as though they have gotten to know the detainee, medical personnel should remain vigilant and be prepared to react if threatened.

I-26. At Level III hospitals, detainee patients should be segregated from U.S. and multinational patients. Detainee patients are guarded by nonmedical personnel designated by the echelon commander while they are patients in the facility. All medical equipment, supplies, and pharmaceuticals should be stored and secured in a room outside the ward. When possible, patients are treated in a room outside the ward. When patients are required to leave the ward, they should be escorted under guard to ensure that they do not attempt to escape, injure hospital personnel or other patients, or damage and/or destroy hospital property.

MEDICAL SUPPORT BEFORE TRANSFER TO AN INTERNMENT FACILITY

I-27. Only limited medical screening can be accomplished at DCPs and DHAs. Medical personnel assigned to the military police unit normally treat detainees at DCPs. If these personnel are not available, the Level II medical treatment facility providing area support may be required to perform a hasty assessment of the detainees at the request of the detaining unit. These support requirements should be included in the operation order when possible. The purpose of this medical screening is to ensure that detainees do not have significant wounds, injuries, or other medical conditions (such as severe dehydration) that would require immediate medical attention or medical evacuation. Medical personnel are screening for conditions that could deteriorate before a detainee is transferred to an internment facility. This screening does not include the use of diagnostic equipment such as X-rays or laboratory tests, as these resources are not available at a DCP or DHA. Any medical treatment provided during screening is entered on DD Form 1380. The detainee's DD Form 2745 number is used as the identification number on the DD Form 1380. If the detainee is not to be evacuated through medical channels, one copy of DD Form 1380 is provided to the detaining unit for inclusion in the detainee's medical record that is initiated and maintained at the internment facility. Medical personnel do not provide security for detainees.

I-28. If medical personnel are not available, emergency medical treatment is provided by the Level II medical treatment facility providing area medical support. Detainees whose medical conditions require hospitalization are treated, stabilized, and evacuated to a supporting medical treatment facility. All medical treatment provided to detainees is annotated on DD Form 1380, and the form accompanies the detainees for inclusion in their medical records at the Level III hospital.

I-29. Injured and ill detainees requiring hospitalization are evacuated through medical channels before being entered into the Detainee Reporting System. Medical personnel do not search, interrogate, or guard detainees being evacuated through medical channels. The echelon commander is responsible for providing this support. Once detainee patients reach the Level III hospital, they are reported in the Detainee Reporting System. When possible, detainees should be segregated from U.S. and multinational forces during evacuation.

I-30. At DCPs and DHAs, field-expedient measures may be required to sustain field sanitation. If sanitation facilities are not feasible, detainees should be given individual waste collection bags and hand-washing stations should be established throughout the DHA. If medical personnel are requested to provide emergency medical treatment at DCPs and DHAs, they should review how field sanitation measures are being implemented. Any deficiencies noted should be corrected on the spot and reported to the chain of command and through medical channels.

MEDICAL SUPPORT AT THE INTERNMENT FACILITY

I-31. Medical support at the facility involves multiple actions, including the responsibility of keeping the facility commander apprised of detainee medical conditions. These actions are discussed in the following paragraphs.

INITIAL MEDICAL SCREENING AND STANDARDIZED PHYSICAL EXAMINATION

I-32. Detainees are screened by medical personnel within 24 hours of their arrival at the internment facility. They are screened for general health and nutritional status, the presence of communicable diseases, preexisting chronic medical conditions, medication history (including current medications), immunization status, weight, and existing wounds or injuries. If detainees have medications on them at the time of internment, the medicine should be bagged, identified, transported by military police personnel, and provided to medical personnel at the internment facility.

I-33. A medical record is initiated for detainee who does not already have one. If the detainee received medical treatment while at the DCP and/or DHA, the copy of DD Form 1380 provided to internment personnel is included in the detainee's medical record. The detainee's weight is recorded on DA Form 2664-R and is updated monthly. (See chapter 5.)

I-34. If a detainee requires immunizations, they are given at this time as specified by the theater detainee health care policy. Additionally, each detainee is given a tuberculin skin test as specified by the theater detainee health care policy. When it is determined that a detainee requires medication on a continuing basis, a dosing schedule is designed.

I-35. Upon completion of the screening and physical examination, DD Form 503 is completed. One copy is maintained in the detainee's medical record, and another copy is provided to internment personnel. This report specifies whether the detainee is mentally and physically qualified to perform hard labor and whether the detainee is free from communicable diseases. This report also has a remarks block to provide additional information if appropriate and required.

DOCUMENTATION OF EXISTING INJURIES OR MEDICAL CONDITIONS

I-36. During the initial screening, medical personnel must ensure that they document all existing injuries and medical conditions. When appropriate, photographs documenting the wounds and injuries should be taken.

I-37. AR 190-8 prohibits the photographing, filming, or videotaping of detainees except for camp administration and intelligence and/or counterintelligence purposes. However, medical personnel are permitted to photograph a detainee to document preexisting conditions, injuries, and wounds. The detainee's identity should be clearly visible. These photographs are invaluable if a claim of unnecessary surgery or amputation is made. Any detainee who requires amputation or major debridement of tissue should be photographed. Once taken, these photographs are maintained as part of the detainee's medical record.

MEDICAL SURVEILLANCE ACTIVITIES

I-38. Medical surveillance is the ongoing, systematic collection of medical data that is essential to the evaluation, planning, and implementation of public health and prevention practices. In particular, it includes medical data related to individual patient encounters; this data is used for calculating disease and nonbattle injury rates in a defined population for the primary purpose of preventing and controlling health and safety hazards. Medical surveillance identifies the population at risk, identifies potential and actual exposures, determines protective measures, and assesses a detainee's health. Medical surveillance is not intelligence gathering.

I-39. The data collected from this assessment forms the health status of detainees. It identifies the endemic and epidemic diseases present in the detainee population, provides the facility commander with pertinent information with which to monitor changes in the detainee health status, and provides the basis to perform health interventions as necessary. Medical surveillance data is used to monitor the implementation and effectiveness of preventive medicine measures and field sanitation and hygiene practices. For example, an increase of acute diarrheal disease within a subpopulation of the detainees may necessitate an epidemiological investigation to determine the cause of the outbreak and to ensure that the spread of the disease is contained. Once the source of the disease outbreak is determined, preventive measures can be devised and implemented to ensure that there is not a recurrence.

I-40. Health risk communications and instructions can be developed and disseminated to detainees to promote an understanding of the medical threat faced by the facility. Dissemination can also enhance compliance with required PVTMED measures, field sanitation requirements, and personal hygiene standards to counter the threat.

MONTHLY MONITORING REQUIREMENT

I-41. To ensure the continued health of detainees, international laws require that each detainee be screened monthly by medical personnel. During this screening, the detainee's weight is recorded on DA Form 2664-R, which provides a concise, chronological weight history of the detainee. Significant fluctuations in weight can signal an underlying medical condition or can indicate that the detainee's diet is not meeting nutritional requirements. Any significant fluctuations must be investigated by medical personnel. Detainees with significant weight fluctuations are given a more thorough physical to determine if an underlying medical condition exists or if a disease is present. If the physical examination does not identify the underlying cause, a thorough evaluation of the detainee's diet and work schedule is undertaken. Findings and recommendations for diet adjustment are made to the facility commander. Cumulative data on weight fluctuations is included in the medical surveillance activities conducted at the facility to ensure that trends are identified as rapidly as possible and that corrective measures are implemented.

I-42. Detainees are also screened regularly for the presence of communicable diseases. Other screenings include louse infestations, hydration, and other indicators of health status.

I-43. If a detainee has any signs of unexplained physical injuries (such as burns, fractures, severe sprains, or bruises), medical personnel should ask the detainee about the cause of the injury. However, medical personnel do not investigate allegations or suspected incidents of abuse. Any cases of suspected abuse, whether by internment facility personnel or other detainees, is documented and immediately reported to the facility commander, the supporting U.S. Army Criminal Investigation Command unit, and the detainee operations medical director.

ROUTINE MEDICAL CARE

I-44. Detainees may receive medical care and schedule a sick call at internment facilities. The medical section of the I/R battalion provides Level I medical care within the facility. The medical personnel assigned to this section are supported through technical guidance provided by higher headquarters.

ADMINISTRATION OF MEDICATIONS

I-45. All medications to be administered to detainees must be dispensed in unit doses by medical personnel. Depending on the detainee's medical condition, health care providers should prescribe medications that can be dispensed on a once- or twice-a-day basis when possible. When dispensing oral medications, medical personnel will verify the identity of the detainee, check the detainee's hands and mouth to ensure the detainee swallowed the medication and is not attempting to hoard the medications for later use. The medication issue registry is primarily used to track the medications that each detainee takes and to prevent medication duplications and potentially dangerous interactions. A local form can be developed to document the dosing schedule and the receipt and administration of the medication to the detainee. At a minimum the form should reflect—

- Date.
- Name of prisoner.
- Medication issued (name and quantity).
- Time and frequency of issue.
- Printed name and signature of person issuing medication.
- Prisoner's acknowledgment for receipt of medication.

I-46. Medical personnel are required to administer medications to detainees, prepare and maintain accurate records, and ensure that all medications are taken as prescribed. If a detainee refuses to take prescribed medications or fails to appear for the administration of medication more than three times, the supervising NCO is notified. If the attending medical personnel believe that the refusal to take medication or that missed medication will seriously affect the health of a detainee, the attending physician is notified.

EMERGENCY MEDICAL CARE

I-47. Emergency medical treatment may be required at any time and any location within the facility. On-site medical personnel should have a standardized emergency medical treatment set that can be accessed rapidly and transported to the incident site. The standardized set facilitates accounting for all medical supplies and equipment that are taken into the detainee enclosure. When possible, the detainee should be removed from the detainee enclosure and transported to the facility's medical treatment area. A guard accompanies the detainee throughout the evaluation. On-site medical personnel treat the detainee and, if appropriate, release the detainee back into the detainee population. If the detainee's medical condition requires treatment beyond the capabilities of the on-site medical team, the detainee is evacuated to a higher level of care.

EVACUATION TO A LEVEL 3 MEDICAL TREATMENT FACILITY

I-48. When a detainee requires evacuation to a higher level of care, interpreter support is required to facilitate medical personnel performing emergency medical treatment en route to the Level 3 medical treatment facility. Interpreter support may be provided by radio transmission, or an interpreter may be onboard the ambulance. Medical personnel onboard the ambulance remain in radio contact with the health care provider at the Level 3 medical treatment facility throughout the evacuation. A guard accompanies the detainee throughout the evacuation. After treatment, the detainee is returned to the TIF by ambulance if appropriate. If the detainee is to be admitted to the Level 3 medical treatment facility, the ambulance crew returns the TIF guard to the duty station. Military police sign the detainee over to the appropriate authorities at the medical facility before departure. Medical personnel not responsible for the security of detainees within a facility. In addition, transportation arrangements should be coordinated to return the

detainee upon restoration of health. The evacuation and medical treatment received are documented in the detainee's health record and on the ambulance run sheet.

I-49. When detainees return to the TIF from the hospital, they are examined by the TIF physician. The hospital provides clear and concise instructions for follow-on care to be given at the TIF. Medical equipment and supplies that are not normally available at the TIF, but required for the continued care of the detainees, are provided by the hospital. The TIF physician coordinates with the hospital for any appointments required for continued care.

MEDICAL LOGISTICS REQUIREMENTS

I-50. A formulary must be established for all medical treatment facilities that provide detainee health support that is specifically tailored to the detainee health care mission. The Defense Medical Standardization Board is a joint DOD activity that provides policy and standardization guidance relative to the development of deployable medical systems and medical material used for the delivery of health care in the military health system. In executing this mission, the Defense Medical Standardization Board establishes and maintains information, to include national stock numbers, on all medications available within the military health system. This listing is available at the Defense Medical Standardization Board Web site <<http://www.jrcab.army.mil>>. The mailing address is Director, Defense Medical Standardization Board, 1423 Sultan Drive, Fort Detrick, Maryland 21702-5013. The detainee operations medical director must ensure that pharmaceutical requirements are identified and that a formulary is developed as early as possible in the mission planning process. Special plans are devised for the following:

- Endemic and epidemic diseases in the operational area and specific AO.
- Chronic health problems within the operational area and specific AO, to include nutritional deficiencies.
- Dosing requirements of various medications (such as requiring administration twice a day versus four times a day).
- Detainee demographics (age, gender).
- Medications currently available within the operational area and specific AO for civilian health care.
- Requirements for obstetric and/or gynecological, pediatric, and/or geriatric health care).
- Requirements for chemoprophylaxis.
- Sufficient stock of medications to combat disease outbreaks within the detainee population (meningitis, tuberculosis, influenza).

I-51. In addition to medical supplies, the supporting medical logistics unit provides medical equipment maintenance and repair and optical fabrication and repair services, as required. Coordination for this support is through the detainee operations medical director.

DENTAL SERVICE SUPPORT

I-52. The scope of dental services available to detainees is determined by the detainee operations medical director according to established theater policy. Operational dental support (emergency and essential) is normally available within a joint operations area. Comprehensive dental care is normally provided in a support base and not in a deployed setting. Internment facilities do not have organic dental personnel or equipment. Depending on the anticipated dental workload, dental assets may be colocated with the internment facility. If dental assets are not colocated with the internment facility, coordination with the supporting dental facility is required. The internment facility must provide the required guard support for detainees being transported to the supporting dental facility.

VETERINARY SERVICE SUPPORT

I-53. Veterinary support for detainees is normally required to ensure food hygiene and safety support for meals. Food must be from approved sources. Veterinary personnel must approve food that is locally procured from the HN. The use of local food is recommended to ensure that the dietary needs of detainees

are met. If the use of meals, ready-to-eat, is required due to mission variables, cultural and religious dietary restrictions must be considered, as meals, ready-to-eat, contain food items that may be prohibited. Humanitarian rations are preferred to meals, ready-to-eat. If meals, ready-to-eat, must be used temporarily, the same standards used for U.S. armed forces must be applied to the duration of use.

I-54. Veterinary support may also be required for MWDs at internment facilities. The support may be required to maintain good health or to treat sick or injured MWDs.

PREVENTIVE MEDICINE SUPPORT

I-55. Preventive medicine personnel, whether assigned to a military police unit or a supporting medical unit, may be required to assist in establishing and/or inspecting a facility. Preventive medicine personnel will also provide detailed guidance to the commander on occupational and environmental health standards, field sanitation and personal hygiene standards, and base camp assessments and inspections.

I-56. Additional information on establishing field sanitation devices (latrines and hand-washing stations) is contained in FM 4-25.12 and FM 21-10. Occupational and environmental health surveillance is required within the facility and when detainees are engaged in work at off-site locations. According to AR 40-5 and FM 4-25.12, unit field sanitation teams are the first line of defense for ensuring that these standards are properly maintained. Preventive medicine personnel will provide direct oversight and support to these teams as necessary.

PEST MANAGEMENT ACTIVITIES

I-57. Pest management activities are conducted within the internment facility to reduce the incidence of disease within the detainee population. Such activities require that—

- Food preparation areas are screened to exclude flies from exposed food. Food service support to internment facilities must meet the requirements in Technical Bulletin, Medical (TB MED) 530. If food is prepared in the camp and detainees work in food preparation, they must receive basic food safety training. Retained medical personnel may assist in training.
- Adequate collection and disposal of refuse are maintained to provide sufficient sanitation within the facility. If the detainees are preparing their own meals, one 32-gallon container is required per 17 detainees. Detainees will have more trash to discard because of food packaging and uneaten and/or spoiled food. If detainees are eating in a centralized dining facility, one 32-gallon container per 25 detainees is required since more trash would be generated in the food preparation area and centrally disposed of there rather than being disposed of in the detainee living area. Preventive medicine personnel are required to ensure that containers are covered to minimize attracting insects and rodents. These containers must be emptied and cleaned daily.
- Latrines and hand-washing devices are established and are maintained daily. The types and number of latrines established are determined by the number of detainees and the length of time that they will be held at a location. Field-expedient measures (individual waste collection bags) may be required at temporary locations, such as the DCP. Facilities must be properly maintained to control fly populations.

I-58. Preventive medicine personnel inspect water supplies to ensure potability. If detainees are preparing their own food, additional quantities of water are required.

FOOD SANITATION AND PREPARATION REQUIREMENTS

I-59. Due to differing national standards and practices for food sanitation and preparation, food service personnel must be instructed on food sanitation and preparation standards to ensure that they know the standards which will be enforced. Preventive medicine support is required to ensure that food preparation and dining facility sanitation are maintained to standard. The food sanitation standards contained in TB MED 530 apply.

I-60. When food is prepared at a central dining facility and brought to the camp in insulated food containers, particular attention must be afforded to holding temperatures. Additionally, the maximum

amount of time that can pass between removing food from the container and serving it must be known and closely monitored.

I-61. Detainees may have personal food items within their designated living space. These items should be inspected to ensure that detainees adhere to food hygiene and safety requirements. Containers used to store these items must protect them from potential contamination such as insects and dirt. Additionally, if the food item is sensitive to heat and/or cold, it must be maintained in a manner that will protect it from spoilage.

I-62. It is possible that a detainee may bring a domesticated animal into the camp and may then request permission to slaughter the animal. Coordination for veterinary support should be addressed to the supporting medical C2 unit.

PERSONAL HYGIENE AND FIELD SANITATION

I-63. Preventive medicine personnel also provide training in personal hygiene practices, field hygiene, and sanitation to detainees. Standards for personal hygiene and sanitation practices should be posted in detainee areas in a language that they understand.

Appendix J

Facility Designs and Sustainment Considerations

Although non-I/R-specific military police units initially handle I/R populations, modular military I/R battalions with task-organized guard companies, MWD teams, and other necessary support are equipped and trained to handle detainee operations for the long term. The I/R battalion headquarters is specifically designed to C2 the support, safeguarding, and accounting of compliant detainees, noncompliant detainees, DCs, or U.S. military prisoners. The higher headquarters for an I/R battalion is typically military police brigade, but may also be an MEB.

DESIGNS

J-1. As the DOD executive agent, the OPMG has responsibility for detainees. This responsibility is then delegated to the combatant commander of the affected area. The combatant commander responsible for I/R operations provides engineer and logistical support for the facility commander to establish and maintain detainee internment facilities. Planning, coordinating, and establishing I/R facilities must begin during the build-up phase of an operation. This will ensure that the facility is ready to receive I/R populations at the start of the operation. I/R facility construction must be included in the planning phase of the operation. Whether the I/R facility is built by engineers or contractors, military police leaders and their staffs must be part of the planning process. There are three different facility designs. Each facility must enable the appropriate segregation, accountability, security, and support of its respective I/R populations. An I/R facility normally consists of 1 to 8 compounds capable of interning 500 people each and is generally of a semipermanent nature. Examples below depict the minimum-security requirements. An excellent document that addresses the planning considerations for all base camp developments, to include I/R facilities, is EP 1105-3-1, produced by the U.S. Army Corps of Engineers.

FACILITIES

J-2. There are three basic focused types of I/R facilities: detainee internment, DC resettlement, and U.S. military prisoner internment. Each facility starts with a modified version (an administrative area and one compound) that has a limited, 25 percent capability for start-up operations and is then typically expanded in increments of 25 percent until it reaches the full facility design with maximum capacity. I/R facilities have a maximum-security area with individual cells to provide individual detention. Based on the situation, some internment facilities will have individual detention cells only.

J-3. Maximum-security cell blocks consist of portable cells that are stored on pallets and come ready to assemble. Maximum-security cells can be assembled as stand-alone cells or hooked together to form a cell block. They can be assembled in a tent or hard structure. Military police can assemble the cell blocks with minimal engineer support to run the plumbing and electrical systems.

J-4. Lessons learned have resulted in design modifications to the internment facility. (See figure J-1, page J-2.) The facility is designed to be expandable in 1,000-person increments. The initial facility is constructed with the administrative area and one 1,000-person enclosure and then expanded by adding (a maximum of 3) additional 1,000-person enclosures. Each 1,000-person enclosure must be self-contained, with electric and water capabilities, and available for occupation immediately upon completion.

DETAINEE INTERNMENT FACILITY

J-5. Figure J-1 shows a TIF comprised of four 1,000-person enclosures, each with two 500-person compounds. Each 500-person compound is further divided into four 125-person compounds. This configuration allows each compound to be isolated and approached from all sides. Compounds are

separated by an appropriate distance to provide an avenue of approach to each, while providing a safe standoff distance from other compounds. The distance allows enough space for security to patrol between compounds and for reaction forces to employ riot control formations and NLWs in response to disturbances.

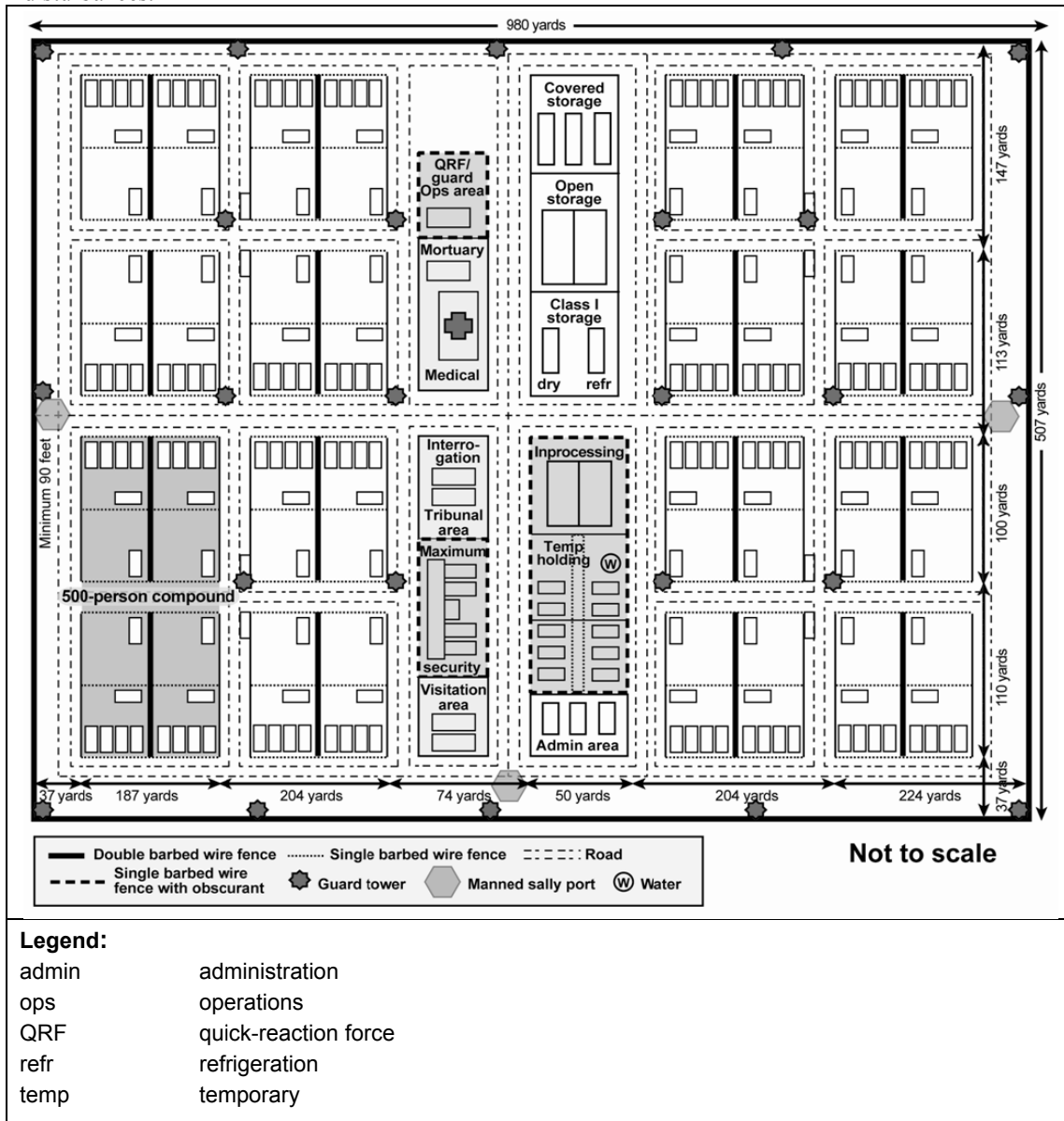

Figure J-1. 4,000-capacity I/R facility for compliant detainees

DISLOCATED-CIVILIAN RESETTLEMENT FACILITY

J-6. The resettlement facility for DCs is designed with an administrative area and up to eight 1,000-person enclosures. The facility is designed to be expandable in capacity increments of 1,000. The initial facility is constructed with the administrative area and one 1,000-person enclosure and then expanded, as needed, by adding additional 1,000-person enclosures until the maximum 8,000 person capacity is reached. Figure J-2 depicts a resettlement facility with eight 1,000-person enclosures divided into two 500-person compounds. The compound is further divided into two 250-person subcompounds. Each 1,000-person enclosure must be self-contained, with electric and water capabilities, and must be available for occupation immediately upon completion.

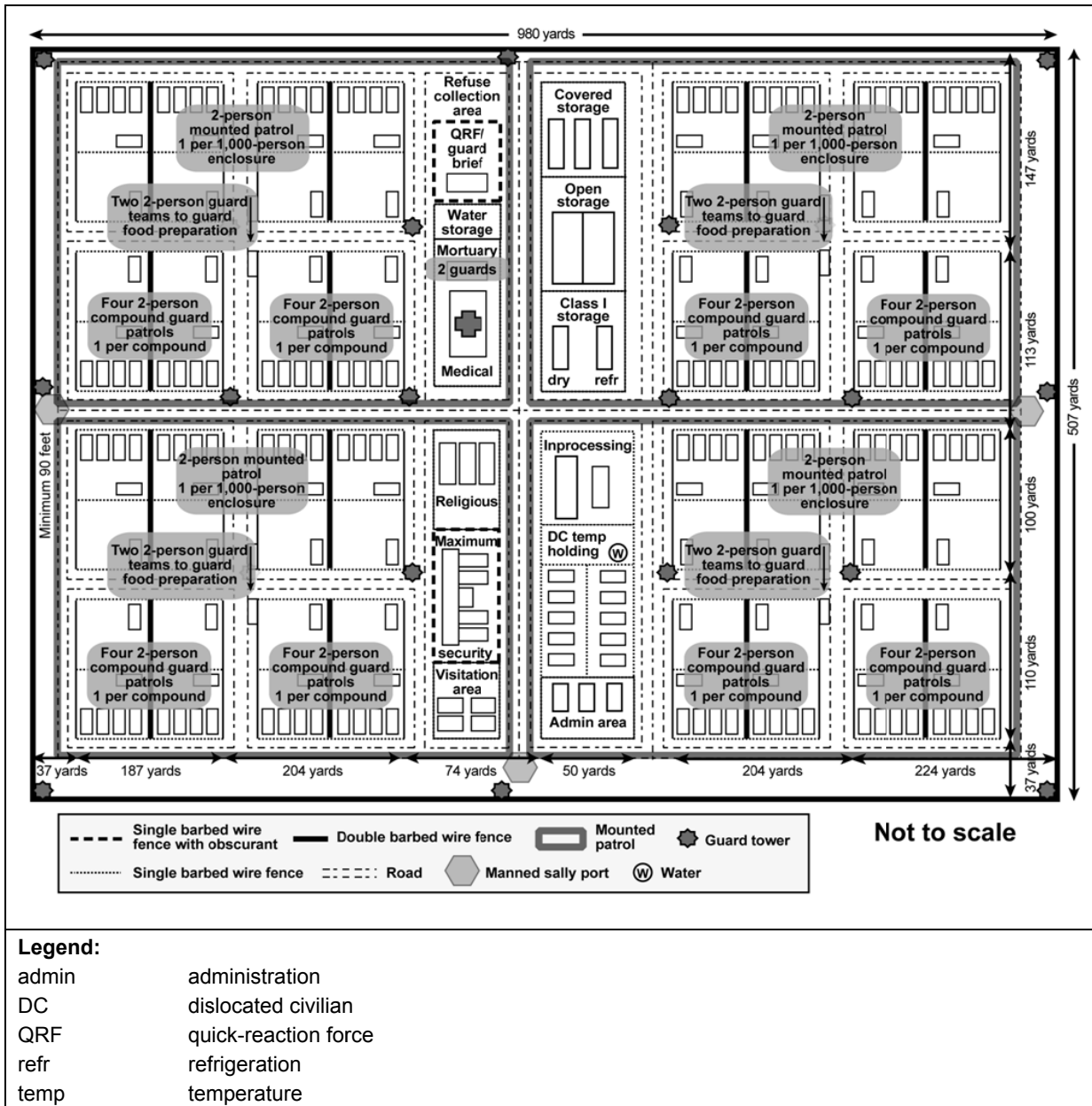

Figure J-2. 8,000-capacity I/R facility for DCs

U.S. MILITARY PRISONER INTERNMENT FACILITY

J-7. The facility for U.S. military prisoners (or noncompliant detainees) contains up to three 100-person enclosures, each with an administrative area. (See figure J-3, page J-4.) The enclosures will be of a semipermanent construction. All three enclosures may be constructed with individual cells, depending on the aggressiveness of the prisoner population. The decision on the type of enclosure required is driven by mission variables and is the responsibility of the facility commander. The facility is designed to be expandable in 100-person increments. The initial facility is constructed with an administrative area and one 100-person enclosure. The facility can then be expanded by adding (a maximum of 2) additional 100-person enclosures. Each 100-person enclosure must be self-contained, with electric and water capabilities, and must be available for occupancy immediately upon completion.

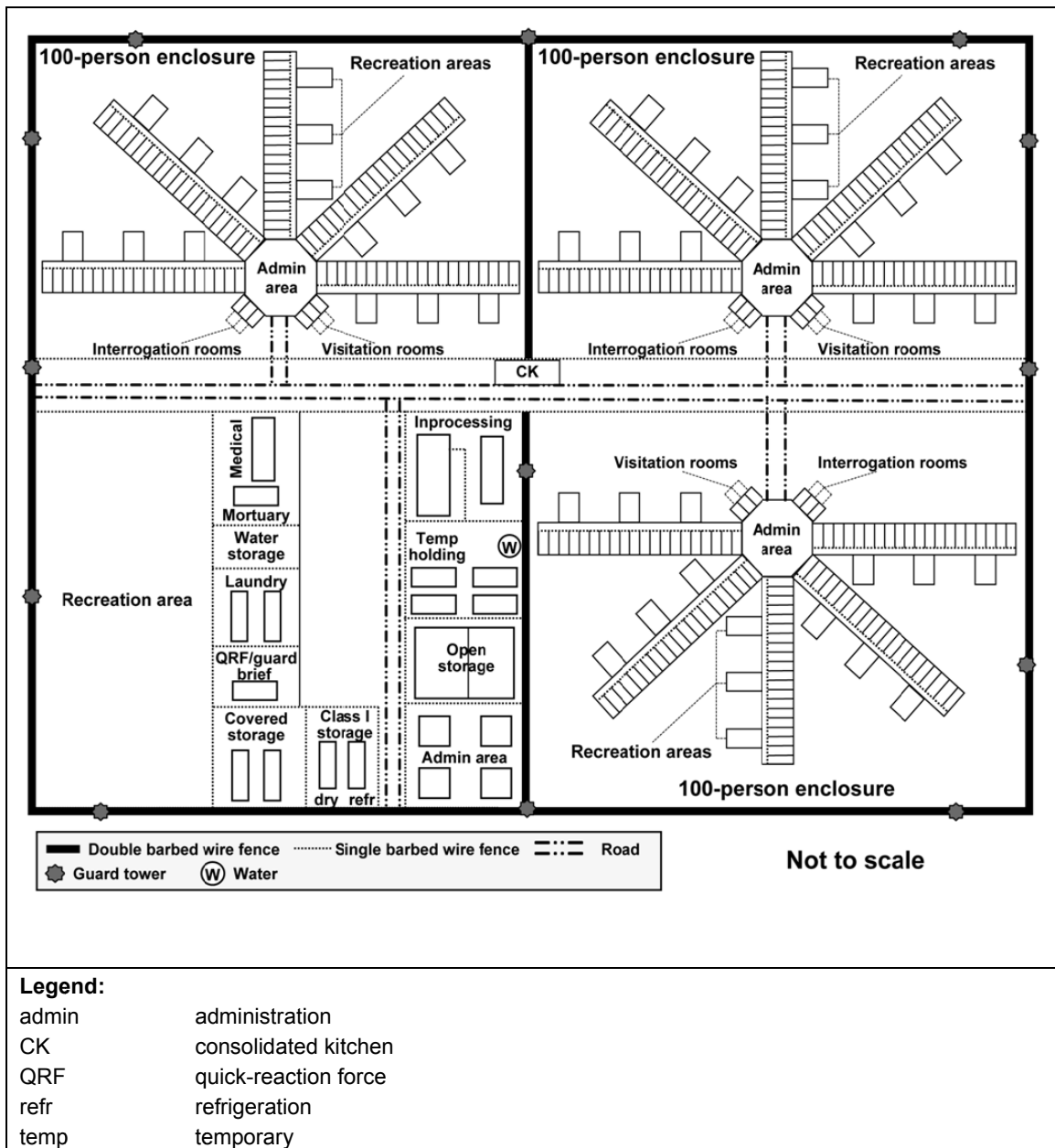

Figure J-3. 300-capacity I/R facility for U.S. military prisoners or noncompliant detainees

J-8. Additional construction requirements for this facility include the following:

- Each cell must have a latrine, sink, and bunk that are attached to the wall.
- Each cell must have steel or concrete walls, a floor, and a ceiling.
- Each cell door must be steel mesh or bars, have a middle and bottom pass-through, and have all hinges and bolts on the outside of the cell.
- No plumbing or electrical wiring in cells can be exposed.
- All cell lights must be shielded.
- All cells must have shutoffs for electric and water.
- Each facility must have a fire suppression system.

- Each facility must have a minimum of one cell that is stripped and padded for an emotionally disturbed detainee. This cell must have a one-way observation window on the administrative area side of the cell.
- All doors of the facility should be installed with manual gang locks, when possible.
- Each interrogation cell must be double-walled and insulated to minimize sound transfer and eavesdropping.
- Each recreation area must have a shower with an observation window; inside plumbing or electrical wiring cannot be exposed. Water shutoffs must be accessible from the catwalk.
- Each recreation area must have steel mesh walls and ceiling, a concrete floor, and shaded areas.

CONSTRUCTION

J-9. Planning for I/R facility construction must be projected well before the start of hostilities to provide for the timely notification of engineers, the selection and development of specific facility sites, the procurement of construction materials, and the actual construction. The Class IV, engineer, and military police requirements must be programmed into the time-phased force deployment data for them to arrive in the theater in time for construction.

SITE SELECTION

J-10. Military police must coordinate the location of each I/R facility with engineers, G-4/S-4 section, sustainment units, higher headquarters, and the HN. Failure to properly consider and correctly evaluate all location factors may increase the sustainment efforts required to support I/R operations. The poor selection of an I/R facility location could require moving the entire I/R population if the surrounding situation worsens.

J-11. When charged with selecting a site for an I/R facility, consider the following questions:

- Will I/R populations pose a potentially serious threat to logistical operations if the tactical situation becomes critical?
- Is there a threat of actual or potential guerrilla activity in the area?
- What is the attitude of the local population?
- What classifications of I/R populations will be housed at the site?
- What type of terrain surrounds the site?
- Will the terrain around the site help or hinder escapes?
- What is the distance from the mandatory supervised release location and the source of sustainment support?
- What methods of transportation are required to move detainees, supplies, and equipment?
- What methods of transportation are available?

J-12. In addition to the questions above, it is also critical to consider the following when selecting a specific site for an I/R facility:

- Mission variables.
- Need to avoid immediate proximity to probable target areas.
- Availability of suitable existing facilities (to avoid unnecessary construction).
- Presence of swamps, mosquitoes, and malarial conditions or other factors, including water drainage that would affect human health.
- Existence of an adequate source of potable water. The water source should be big enough to meet the demands for drinking water and food sanitation. Water for personal hygiene and sewage disposal may come from a nonpotable source.
- Availability of local electrical power. Portable generators are preferred as a standby or emergency source of electricity.
- Employment of detainees on work details outside the facility.
- Availability of local construction material.
- Possibility of soil drainage.

CONSIDERATIONS

J-13. The specific type of construction necessary to satisfy minimum requirements varies according to the—

- Climate.
- Anticipated permanency of the facility.
- Number of facilities to be established.
- Labor and materials available.
- Local construction material available.

Note. It is essential that the G-4 coordinate with military police and engineers to ensure that substitute items are acceptable. For instance, if the requirement is for 100-foot light poles to illuminate the facility, substituting five 20-foot poles per one 100-foot pole will not suffice. The capabilities of the 20-foot poles are diminished in that the height of the pole is a major factor in determining the illuminated area.

- Conditions under which the detaining power billets its forces in the same area.

J-14. Local vacant buildings may be used if practical. This reduces the requirements for engineer construction materials and personnel. I/R populations and local sources of materials are used to the maximum extent possible to accomplish necessary modifications or construction. Tents are the most practical means for housing I/R populations if existing facilities are not available.

J-15. The U.S. Army Corps of Engineers has developed the military police proponent-approved I/R facility designs in the Theater Construction Management System, which contains basic plans with specifications and material requirements for building I/R facilities based on the anticipated I/R population. These plans are easily modified for temperate, frigid, tropic, and desert climates. The Theater Construction Management System can also provide specifications and material requirements for other I/R facilities when dimensions and/or population input is supplied.

J-16. Construct the facility, when feasible, in a manner so that the compounds and subcompounds within the facility are sufficiently separated from each other to preclude communication between detainees. Take full advantage of existing irregular terrain features as obstacles to such communication. Commanders must not extend the distance between compounds within the facility to a point that security and efficient operation of the facility is jeopardized.

J-17. Commanders should realize that modifications to design specifications may occur based on mission variables. For example, when a compliant population is forecasted for internment, design specifications may provide for merged compounds to allow for larger capacity. Conversely, modifications to further divide the facility compounds might be required if detainees are violent or noncompliant. Additional modification considerations may include the—

- Geographic location.
- Number of guard force personnel available.
- Availability of logistical support (for example, lighting and infrastructure design).

FACILITY DESIGN MODIFICATIONS

J-18. Military police planners, and ideally the commander of the unit responsible for occupying the I/R facility, advise and assist with I/R facility design by providing input during the facility design and construction process. Facility designs are assessed and modified based on mission variable considerations. The diversity of I/R populations and their respective security requirements may require the modification of existing structures to provide appropriate custody and control. Additionally, facility designs may require modification to accommodate long-term strategic objectives. For example, the transition of noncompliant detainees to the control of civil penal authorities may require facility modifications to more closely conform to minimum penal structural standards.

J-19. Figure J-4 is an excerpt from the 4,000-person facility in figure J-1, page J-2. The figure reflects an enhanced diagram of a 500-person compound and shows the actual number of general-purpose, large tents 18 feet by 52 feet required to house 125 detainees.

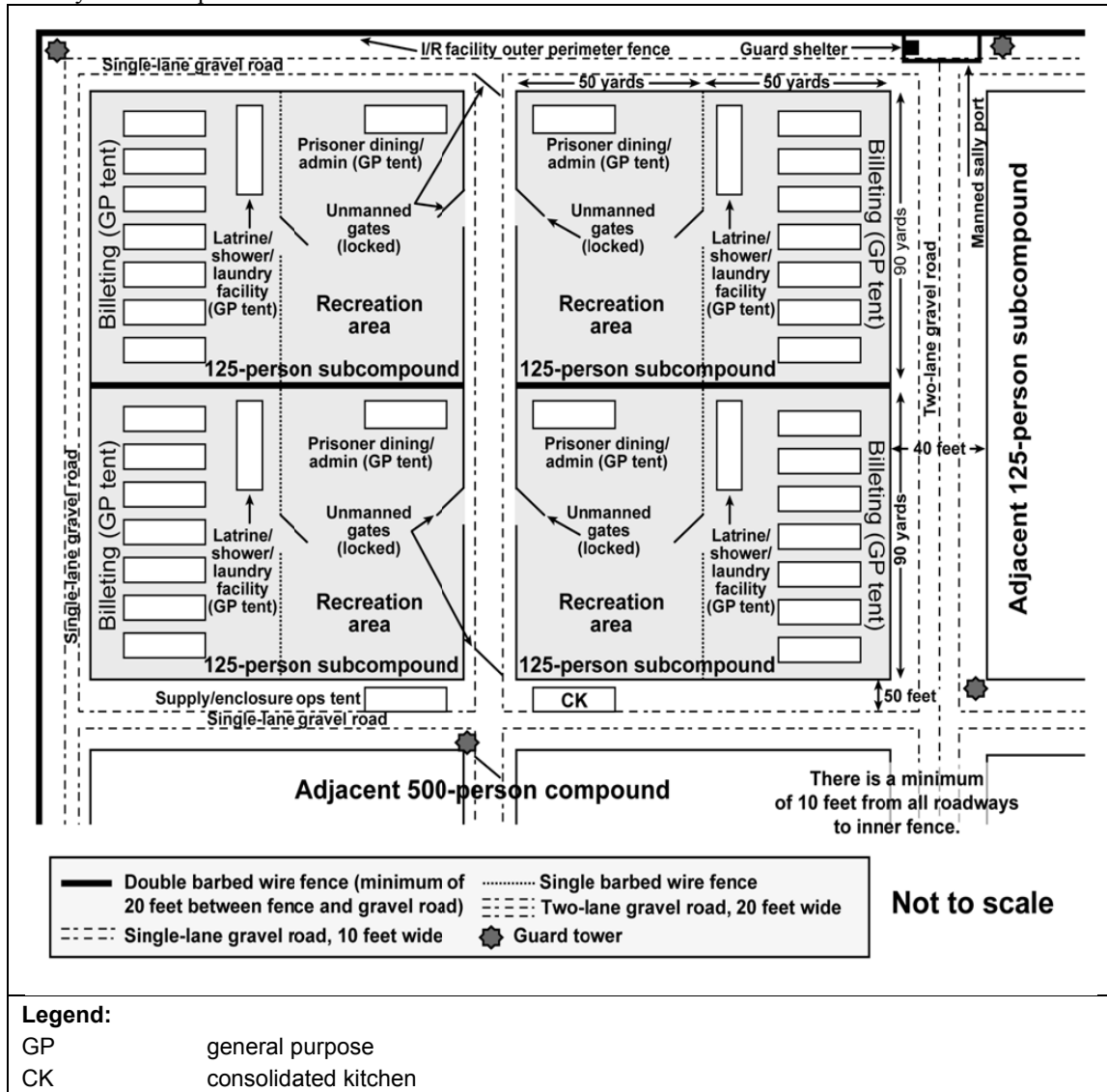

Figure J-4. 500-person compound

J-20. As illustrated in figure J-1, page J-2, the TIF is comprised of eight 500-person compounds, and each is divided into four 125-person compounds. This configuration allows compounds to be isolated and approached from all sides. Compounds are separated by an appropriate distance to provide an avenue of approach to each compound, while providing a safe standoff distance from other compounds. The distance allows enough space for security elements to patrol between compounds and for reaction forces to employ riot control formations and NLWs in response to disturbances.

MINIMUM REQUIREMENTS

J-21. I/R facilities must meet minimum security requirements. To satisfy the minimum requirements, each I/R facility requires the items discussed in the following paragraphs.

Note. The military police proponent-approved facility designs are in the U.S. Army Corps of Engineers Theater Construction Management System database and should be used when planning facility construction. While mission variables may cause changes to these designs, remember that the capabilities listed in Section I of the I/R tables of organization and equipment are based on these designs, and any deviations from the approved designs may reduce the stated capabilities of I/R units performing the internment mission if appropriate; corresponding task-organization changes are not affected.

CLEAR ZONE

J-22. The 12-foot clear zone must be free of vegetation and shrubbery. The clear zone is constructed around the circumference of the facility, between the inside and outside perimeter fences. A minimum 20-foot clear zone will be maintained on the exterior of the outermost perimeter fence. The use of concertina or razor wire as additional barrier protection at the top and bottom of perimeter fencing is authorized.

FENCING

J-23. Double exterior fencing will be installed around facility recreation, exercise, and work yard areas. Fencing will be constructed of a type indicated in FM 5-34. It will be at least 12 feet tall with an 18- to 24-inch top guard (preferably spring-type) constructed on all vertical perimeter fences and on interior fences when added security is desirable. Based on local determination, some fencing may require the installation of a double overhang (overhang fencing outward and inward). Razor or concertina wire may be substituted for overhangs when determined appropriate by the facility commander.

ENTRANCES

J-24. All entrances passing through a double fence must have a sally port that will accommodate a 40-foot commercial truck with trailer. Personnel at sally ports are required to search vehicles and personnel entering or leaving the main facility. Consider having a back entrance when a sally port is present.

J-25. Gates requiring 24-hour manning must have a sentry box and/or shelter adjacent to the gate. The main entrance must have a separate pedestrian entrance (sally port) adjacent to the vehicular entrance. This entrance must be a building and/or tent that is large enough for a badge issue point, weapons racks, and shelving to accommodate personal items being held for visitors entering the facility.

GUARD TOWERS

J-26. Guard towers must be located on the perimeter of each facility and compound (optional for DC facilities). Guard towers must be—

- Built so that they are portable and require minimal effort to move.
- Built with a roof.
- Built high enough (20 feet from the ground to the floor of the tower) from the ground to permit an unobstructed view of the compound, but low enough to permit an adequate field of fire.
- Placed immediately outside the wall or, in case of double fencing, placed in such a manner as to permit an unobstructed view of the distance between the fences.
- Spaced to allow for overlapping observation and fields of fire. During adverse weather, it may be necessary to augment security by placing fixed guard posts between towers on the outside of the fence.
- Equipped with platforms sufficiently wide enough to mount crew-served weapons.
- Equipped with retractable ladders.
- Spaced so that guards have an uninterrupted view of 200 yards in any direction along the perimeter fence.

- Located so that the entire perimeter and all parts of the billeting and recreation areas can be observed.

LIGHTING REQUIREMENTS

J-27. The following lighting requirements must be met:

- Lighting must illuminate the entire facility at night to assist in the accountability and control of the I/R population, prevent escapes, and provide safety to the I/R population and the protecting and/or guarding forces.
- Lighting must sufficiently illuminate inner strategic points to expedite the handling of sudden problems caused by I/R populations.
- Emergency lighting provisions must be provided.
- Lights must be protected by unbreakable glass shields or wire mesh screens.
- Lighting placement on walls and fences must not interfere with tower guards' field of vision.

PATROL ROADS

J-28. Construct patrol roads for vehicle or foot patrols adjacent to the outside perimeter fence or walls. Security forces conduct patrols on patrol roads, while maintaining communications with the force at all times.

COMMUNICATION

J-29. Communication between the towers and operation headquarters must be reliable. Telephones are the preferred method. Alternate forms of communication (radio, visual, or audio signals) should be in place as a backup in case of operational interruptions.

POWER

J-30. The facilities must be divided into four grids for prime power support to minimize the negative effects of power loss and escape attempts. This requires at least four 28-kilowatt generators to support the facility. The generators are placed outside the I/R facility perimeter fence in a bermed area to minimize noise pollution.

RECREATION AREA

J-31. In each enclosure, a recreation area is provided for detainees to use on a scheduled basis. Recreation provides a necessary outlet for the I/R populations' energies and offers a break in the daily routine of extended internment. Sports and activities involving physical activity promote the general health and well-being of the I/R populations. These activities are conducted on a daily basis in the recreation area.

LAYOUT AND INTERNAL STRUCTURES

J-32. The facility layout depends on the nature of the operation, available terrain, building materials, and HN support. These variables provide the basic foundation from which the facility commander can add or delete additional design considerations or engineer enhancements based on specific theater requirements. The standard 4,000-person I/R facility consists of thirty-two 125-person subcompounds. (See figure J-1, page J-2.)

INTERNAL STRUCTURES

J-33. Each compound in the I/R facility generally has the following structures:

- Administrative buildings.
- Barracks (which in the early stages of the operation may be tents).
- Dining facilities.

- Bathhouses.
 - Latrines.
- J-34. The administrative area of the I/R facility consists of the—
- Command post and administrative building.
 - Receiving and processing center. (See figure J-5.)
 - Religious and educational buildings.
 - Interrogation facility.
 - Dispensary and infirmary for the treatment of minor illnesses and injuries.
 - Temporary mortuary facility.
 - Supply building for limited storage and issue of selected expendable supplies.
 - Class I storage (dry and refrigeration) and dining facilities.
 - Latrines.
 - Parking areas.
 - Trash collection points.
 - Potable water points.
 - Open and covered storage areas.
 - Generator and fuel areas.

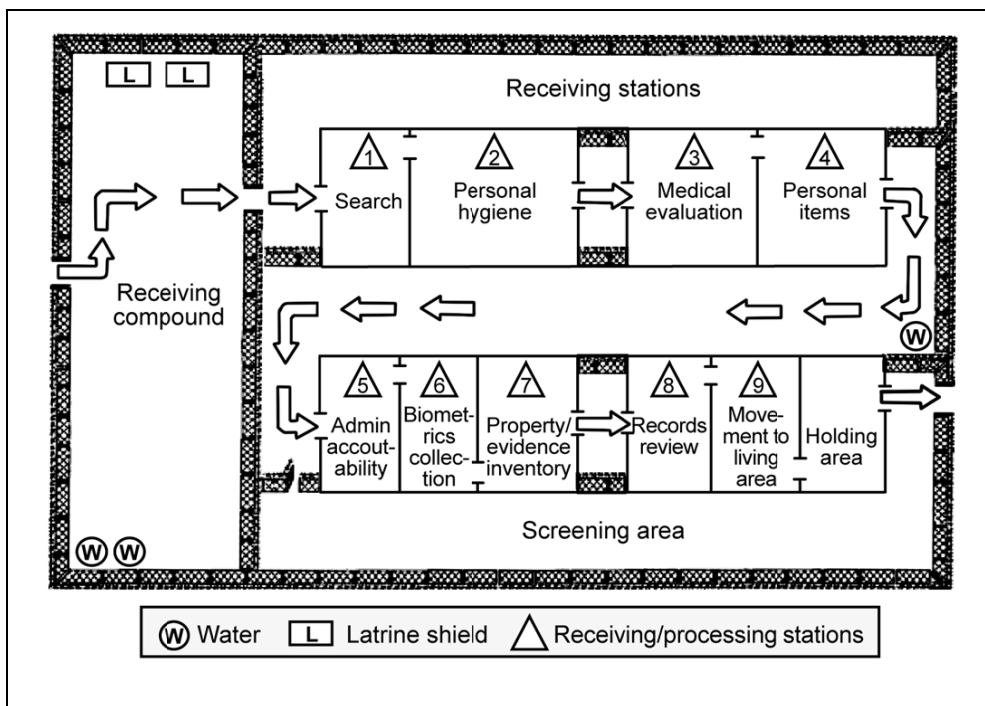

Figure J-5. Detainee receiving and processing operation

SERVICE REQUIREMENTS

J-35. An I/R facility must have certain services and equipment available to ensure fluid operations. The following paragraphs describe many of these requirements. Most are required at all times, but some are based on theater requirements.

J-36. The prescribed standards of treatment and care discussed earlier place a high demand on the sustainment system. To the greatest extent possible, the commander should direct that detainees wear the clothing they were wearing when they were captured or when they arrived at the facility. Supplies and

equipment that were taken with the detainees are also used to the fullest extent possible in maintaining detainees. To avoid the exploitation of supplies and equipment by detainees, properly secure and account for all supply items.

Detainee Receiving and Processing Centers

J-37. Detainees must be fully processed before being interned, evacuated out of theater, or repatriated. Separate processing centers may be established near transfer points to accomplish this. The size of the processing center depends on the anticipated capture rate. When establishing a receiving and processing center—

- Contact engineers to arrange for construction.
- Provide shelter, water, and latrines.
- Use existing structures, if available, and use tents if existing structures do not exist.
- Arrange each processing station to prevent the detainees from knowing what is taking place in the next station.

Subsistence

J-38. The basic daily food rations must be sufficient in quantity, quality, and variety to keep detainees in good health and to prevent weight loss or nutritional deficiencies. Commanders must consult with physicians and dieticians regarding the caloric intake for the I/R population. Iron is needed to prevent anemia. Iodine needs can be met by preparing foods with iodized salt. (See the Food and Nutrition Board, National Institute of Medicine Web site at <<http://www.nal.usda.gov/fnic/etext/000105.html>> for the recommended nutrient minimums based on the dietary reference intakes.) Medical personnel are to keep the commander and detainee operations medical director apprised of any situational needs and the nutritional health of the general I/R population. When possible, culturally sensitive foods may be served. Working detainees may be given additional rations when required. It is the commander's responsibility to sustain the health of the detainees at a level that is equal to that of the U.S. armed forces guarding them.

J-39. When dining facilities are not available, feed detainees field rations (U.S. or captured). These rations (for example, meals, ready-to-eat) are easily stored and require no additional dietary supplements. However, when perishable food supplies (such as fresh vegetables or fruits) are available, they should be substituted for nonperishable items. This prevents the detainees from stockpiling rations for escapes. The I/R units that operate these facilities are designed to have detainees prepare their own meals under the supervision of U.S. armed forces. (See AR 190-8.) Sufficient drinking water (this means no less than what U.S. armed forces receive) and latrine facilities are provided for the detainees.

Note. If detainees are given meals, ready to eat any hardware within the meals should be taken out and accounted for before giving the meals to them. Planners and facility operators should always consider the security of the guard force when determining what and how to feed detainees.

J-40. The I/R battalion provides food service support for up to 4,000 detainees and the 450 or more U.S. armed forces personnel who are required to support the I/R facility. A fully operational I/R facility will have 4 dining facilities (one per 1,000-person enclosure) for the detainees and 1 or 2 dining facilities for the U.S. armed forces. Rations cannot be stored in the compounds and must be issued before the preparation of each meal. The I/R battalion requires enough dry- and cold-storage areas to operate a consolidated ration point and the appropriate MOS 92A personnel to operate the ration breakdown and/or distribute rations to the compound.

J-41. Article 26, GPW, requires the facility commander to consider the habitual diets of detainees. According to Article 26, GPW, detainees will prepare their own meals under the supervision of U.S. food service personnel. The I/R battalion requires enough 92G personnel to train detainees on the operation of food service equipment, oversee and supervise meal preparation, and account for rations. When detainee food preparation is deemed inappropriate by commanders, they may authorize the contracting of food

services to an outside source or coordinate with U.S. food service units providing area support for food service support.

J-42. During the early stages of internment, detainees should be allowed to retain their own rations. However, arrangements for the collective feeding of detainees according to the terms of the Geneva Conventions should be made at the earliest opportunity.

Food Service Equipment

J-43. Requirements for I/R facility food service equipment vary depending on the habitual diets and customs of the detainees. When the commanders deem that it is appropriate, they may authorize the local procurement of cooking equipment for the detainees to use instead of standard-issue equipment.

Food Service Personnel

J-44. Qualified food service personnel are authorized in each I/R company and detachment. They provide food service support for each compound. While selected detainees are trained to perform food service support for each compound, they must be trained by and under the constant supervision of U.S. food service personnel.

Chapel Facilities

J-45. Facility commanders will establish policies, procedures, and religious support for detainees to have the opportunity to practice their faith. Practices of religious faith must not cause disruption to the order and discipline within the facility and/or pose a threat to the safety of persons involved.

Recreational Equipment

J-46. Recreational equipment can be obtained through supply channels. If it is not available through supply channels, the equipment may be secured through local purchase.

Cleaning Supplies

J-47. Each I/R facility has requirements for housekeeping supplies, which vary considerably in the types and quantities needed. The requirements are based on the environment, the type of housing, and the food service facilities available. CTA 50-970 contains an extensive listing of such supplies. Use CTA 50-970 as a guide for developing individual facility allowances for janitorial and cleaning supplies. Always ensure that there is plenty of potable water storage available in each of the compounds. All cleaning supplies are considered as controlled items.

Medical and Sanitation Operations

J-48. Every I/R facility has an infirmary where I/R populations with contagious diseases, mental conditions, or other illnesses (as determined by the medical officer) are isolated from other patients. Medical treatment is available for all detainees onsite or via supporting medical facilities. All dental and optometry support will be provided by supporting medical units, and detainees with illnesses that require surgery or long-term hospitalization will be taken to the supporting medical facility.

J-49. The U.S. takes all necessary sanitary measures to ensure a clean and healthy facility to prevent epidemics. Detainees have access, day and night, to latrines that conform to the rules of hygiene and are maintained in a constant state of cleanliness. Separate latrines are provided for female detainees. Sufficient water and soap are provided for detainees' personal needs and laundry. The time and facilities necessary for those purposes are made available. (See appendix I for more information on medical and sanitation considerations.)

J-50. Consider the following sanitation standards to help prevent disease and to ensure the cleanliness of the facility:

- Provide adequate space within housing units to prevent overcrowding.
- Provide sufficient showers, latrines, and materials for personnel hygiene for detainees, and ensure that showers and latrines are cleaned and sanitized daily.
- Teach individuals working in the dining facility the rules of good food sanitation, and ensure that the rules are observed and practiced.
- Properly dispose of human waste to protect the health of all individuals associated with the facility according to the guidelines established by preventive medicine.
- Provide sufficient potable water for drinking and food service purposes and sufficient water for bathing and laundry purposes.
- Provide information to detainees concerning proper hygiene, sanitation, and food sanitation in a language that they understand.

SUSTAINMENT REQUIREMENTS

J-51. Planners maintain situational understanding of the needs within the facility through all classes of supply. In addition, they must forecast 24 to 72 hours ahead to ensure that the facility is properly maintained. Commanders and planners need to be deeply involved in the sustainment aspects of detention operations, starting from the initial POC to the DHA and, subsequently, to the TIF or SIF. Failure to maintain the logistical standards impacts operations and may bring unwelcome attention from the news media and the ICRC. The following are some of the factors to consider when planning and developing sustainment standards for an internment facility:

- **Acquisition law and/or procedures for detainee supply requirements.** Planners need detailed information on how to acquire and maintain supplies to meet the needs of the facility.
- **Airport and/or seaport throughput capacity (current and projected).** Planners need to determine if there is a standard flow of aircraft and/or ships in a given location and how they can access those resources to ensure that the internment facility is properly supplied and maintained.
- **Airfields in the operational area.** Planners need the locations of airfields when determining a suitable location for a facility.
- **Aircraft line of communications requirements and status.** Planners and operators at the internment facility must ensure that they have visibility of aircraft arriving with detainees.
- **Multinational support.** Planners need to consider what resources multinational support elements will bring to internment operations.
- **Area damage control and firefighting resources.** Planners must develop an SOP that addresses the required response of forces in the event of a fire in the detention facility.
- **Chemical alarms.** Planners must develop an SOP that addresses the required response of the guard force in the event of a chemical attack on the facility or the compound on which the facility is located.
- **Clothing for detainees.** Planners need to consider how clothing items will be purchased, supplied, accounted for, and maintained in the facility.
- **Health, veterinary, and preventive medicine service support.** Planners must identify the status of current medical, optometric, and dental personnel who support the internment facility and its projected needs.
- **Medical logistics.** Planners need to consider the requirements for Class VIII supplies, medical equipment, medical equipment maintenance and repair support, dental support, optometric support, single- and multivision optical lenses fabrication, and spectacle fabrication and repair to support the I/R population.
- **Commander's supply priorities.** Planners need to consider internment facility requirements when recommending supply priorities to the commander.

- **Support coordination.** Planners need to consider the type of day-to-day support (engineer, medical, dental, religious) needed to run and maintain the facility. Sending those requirements to higher headquarters ensures that assets will be available.
- **Food and water consumption factors.** Planners must conduct a detailed analysis of the consumption rates and the projected consumption rates to assist in ordering and maintaining food and water supplies for detainees. In addition, they must identify food and water requirements for the guard force and personnel supporting the facility.
- **Contractor support.** Planners must determine what the screening and/or vetting process will be for allowing contractors with local indigenous personnel in or near the facility. In addition, they must identify where contractors may be best used.
- **Echelons-above-corps sustainment unit adequacy.** Planners must determine what the logistical transportation distances are for providing support to internment facility supply operations.
- **Emergency resupply plans.** Planners need contingency plans for implementation if logistical needs are not being met within the facility (for example, if Class I supplies do not arrive). They should anticipate contracting out with local and/or HN personnel for these necessities. They should identify where these supplies are located and how they can be accessed for use in the facility.
- **Engineering and construction standards and/or policies.** Planners need the structural requirements for building and maintaining the facility. Such structures include guard towers, fencing and/or barriers, isolation facilities, latrine and/or shower facilities, perimeter security requirements, and construction standards. This information is available in the Theater Construction Management System database.
- **Disposable restraint availability.** Planners must ensure that disposable restraints are available.
- **Food service support.** Planners need to determine if there are any special religious and/or cultural requirements for detainees.
- **Time-phased force deployment data considerations.** Planners must identify the force and Class IV materials necessary to conduct the mission. They must also identify what external assets are required to run and maintain the facility. Medical and dental personnel, SJA, chaplain support, and engineer support should be specifically considered. Military police planners, engineer units, and construction materials must be scheduled on the time-phased force deployment list early enough during the build up to ensure that facilities are built and operational before the start of hostilities.
- **Generator availability.** Planners must determine the lighting (internal and external) and generator requirements necessary to maintain security within the facility. In addition, they must determine the number of mechanics needed to maintain the generators. They should walk the ground in and around the holding area and the corridors along the perimeter to ensure that all dead space and dark spots are covered with light and covered by guard towers.
- **Heavy equipment needs.** Planners must consider any special equipment requirements necessary to maintain and sustain the facility. For example, they must determine if trenches are required for bunkers to mitigate indirect fire and if a latrine trench is needed for detainees.
- **HN support arrangements.** Planners should consider what HN assets are available to support the facility in terms of food and clothing. This is especially important when meeting religious or cultural needs.
- **Key control SOP.** Planners need to ensure that key control and accountability are in the SOP and are properly supervised and checked leadership.
- **Labor and funding sources.** Planners must consider where and how funding is obtained.
- **Interpreters and translators.** Planners must consider the proper number of interpreters and translators based on the number of detainees within the facility.
- **Litters.** Planners must ensure that SOPs and guard orders identify the locations of litters and other medical resources in the event of a medical emergency.
- **Local purchase procedures and theater policy.** Planners must identify the requirements for purchasing food, clothing, and water locally.

- **Sustainment situational understanding at all levels.** Planners must maintain situational understanding of the needs within the facility through all classes of supply. In addition, they must forecast 24 to 72 hours ahead to ensure that the facility is properly maintained.
- **Sustainment capabilities.** Planners must identify current and projected requirements for the facility and the means to meet those requirements.
- **Sustainment shortfalls and/or challenges.** The detention facility commander should meet weekly with all personnel involved in facility operations to identify sustainment shortfalls.
- **Sustainment infrastructure maturation.** Planners must attempt to improve the conditions for detainees, the guard force, and MI personnel.
- **Sustainment lessons learned.** Planners should consider previous lessons learned when developing plans and contingencies for detention operations.
- **Long-lead procurement items.** Planners should identify any requirements that may take an extended period of time to arrive at the facility and identify measures to mitigate risk in the interim.
- **Media coverage.** Planners should develop a media plan and provide guidance on media operations to all personnel involved in detention operations. All media plans must be approved by the Office of the Secretary of Defense.
- **Mortuary affairs.** Planners should provide the guidance for related to detainee deaths while in custody at an internment facility, the notification process, and the media guidance.
- **Public address system.** Planners should consider how to deliver information that needs to be addressed to all the detainees. They should identify systems available for audio pickup.
- **Ration cycle for detainees.** Planners must ensure that ration cycles for detainees are consistent with the ration cycle for U.S. or multinational forces, taking cultural and religious requirements into account.
- **Initial POC considerations.** Planners must determine what additional requirements are needed at the initial POC, such as—
 - Sealable bags and/or trash bags.
 - Disposable restraints.
 - Type III nylon cord (parachute line).
 - Duct tape.
 - DD Forms 2745.
- **Riot control considerations and equipment.** Planners must identify what riot-related requirements are needed at initial and long-term detention facilities, such as—
 - NLWs.
 - Release authority determination.
 - Shinguards.
 - Helmet and/or face shields.
 - Batons.
 - Body shields.
 - Groin protectors.
 - CBRN masks.
 - Gloves.

CLOTHING

J-52. When dealing specifically with enemy combatants, clothing, underwear, and footwear should be supplied to them in sufficient quantities. Allowances will be made for the climate where they are housed. Captured uniforms of enemy armed forces will, if suitable for the climate, be made available to clothe them. The detention facility commander ensures the regular replacement and repair of detainee clothing. Detainees who work will receive clothing appropriate to the nature or location of the work demands.

Clothing worn by detainees at the time of capture may be worn until it is no longer serviceable, and then it is exchanged for replacement clothing.

J-53. Except for hats and other accessories, all outer garments worn by detainees will be marked with the letters “PW” across the back and on the front of each sleeve, between the elbow and the shoulder. (See figure J-6). The letters will be black in color and 4 inches in height. If the clothing is a dark color, white lettering is used. Trousers, walking shorts, and like items will be similarly marked just below the belt on the back and front of both legs just above the knees. RP and CIs may be issued clothing that is similar to the items worn by enemy combatants and it will be marked the same as show in figure J-6.

Note. Detainees being categorized as enemy combatants, RP, and CIs are clothed according to AR 190-8.

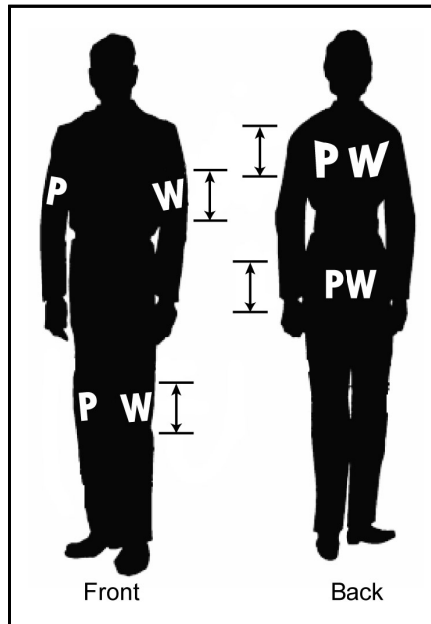

Figure J-6. Clothing markings

INDIVIDUAL EQUIPMENT

J-54. Table J-1 is an example of individual equipment that may be issued to detainees when their clothing becomes unserviceable. Commanders may refer to CTA 50-900 when determining what clothing to issue. Sundry packs and recreational equipment will also be needed, and the military police facility commander may arrange for these items through unit supply or a local purchase. In addition to unit supply operations personnel, the I/R battalion requires sufficient unit supply support to operate a separate supply facility for each 1,000-person enclosure and sufficient staff to oversee this complex supply operation.

Table J-1. Sample individual equipment

Line Item No.	Item, Basis of Issue, and Remarks	Unit	Allowances						
			Zone I	Zone II	Zone III	Zone IV	Zone V	Zone VI	Zone VII
B60252	Belt, trousers, cotton webbing, 1 ¹ / ₄ inch, per detainee.	Each	1	1	1	1	1	1	1
C06886	Boot, combat, men's, leather, black, 8 ¹ / ₂ inch high, per detainee.	Pair	1	1	1	1	1	1	1
C32182	Buckle, belt, trousers, brass, lacquered finish, per detainee.	Each	1	1	1	1	1	1	1
C03750	Cap, hot weather, polyester and rayon, olive green shade 106, per detainee.	Each	1	1	1	1	1	1	1
C04000	Cap, wool, knit, per detainee.	Each	--	--	1	1	1	1	1
G48939	Drawers, men's, cotton, thigh length, white, with elastic waistband, per detainee.	Pair	2	2	2	2	2	2	2
G49213	Drawers, men's, wool, knit, ankle length, silver gray, per detainee.	Pair	--	--	2	2	2	2	2
J62858	Glove inserts, wool and nylon, knit, olive green shade 108, per detainee.	Pair	--	--	1	1	1	1	1
J63269	Glove shells, leather, black, per detainee.	Pair	--	--	1	1	1	1	1
K35007	Helmet, sun, adjustable chin strap, adjustable head size, per detainee.	Each	1	1	1	--	--	--	--
L70789	Liner, wet weather, poncho, camouflage color, per detainee.	Each	--	1	--	--	--	--	--
P17415	Poncho, coated, nylon, olive green shade 207, per detainee.	Each	1	1	1	1	1	1	1
T03520	Shirt, men's, cotton or sateen, olive green shade 107, per detainee.	Each	--	--	2	2	2	2	2
T04205	Shirt, men's; wool, nylon, flannel, olive green shade 108, per detainee.	Each	--	--	2	2	2	2	2
T93335	Socks, men's, wool, cushion sole, olive green shade 408, stretch type, per detainee.	Pair	4	4	4	4	4	4	4
X36358	Trousers, men's, cotton or sateen, olive green shade 107, per detainee.	Pair	2	2	2	2	2	2	2
X37180	Trousers, men's, wool serge, olive green shade 108, per detainee.	Pair	--	--	2	2	2	2	2
B72225	Blanket, bed, wool, olive green, per detainee.	Each	1	1	2	2	3	3	3
--	Brassard, red cross, per RP	Each	2	2	2	2	2	2	2
F54817	Cup, water, canteen, steel, per detainee and RP.	Each	1	1	1	1	1	1	1
N53095	Pan, mess kit, per detainee.	Each	1	1	1	1	1	1	1
Zone I – Warm or hot all year. Zone V – Warm or hot summers, cold or very cold winters. Zone II – Warm or hot summers, mild winters. Zone VI – Mild summers, cold winters. Zone III – Warm or hot summers, cold winters. Zone VII – Mild summers, very cold winters. Zone IV – Mild summers, cool winters.									

ELECTRONIC SEARCHING DEVICES

J-55. Nonintrusive devices can be used to conduct a body search of detainees to identify weapons or other objects used as weapons. These devices may be used to screen personnel during combat and noncombat operations, apprehensions, field interviews, detainee operations, and CI operations and at access control points.

PRISONER TRANSPORT PROTECTIVE SYSTEM

J-56. The Prisoner Transport Protective System is designed to incorporate existing leg irons and full-body restraint systems. This system includes—

- Improved handcuffs.
- Temporary cinch strap.
- Disposable wrist restraints.

J-57. Additional equipment may include—

- **Batons and holders.**
 - Patrol baton (9999-01-499-9918).
 - Patrol baton holder (9999-01-499-9923).
 - Riot control baton (9999-01-499-9924).
 - Riot control baton holder (9999-01-499-9927).
- **Handcuffs and restraints.**
 - Handcuff (8465-01-515-3151).
 - Cinch strap (8465-01-515-3155).
 - Full-body restraint (8465-01-514-8739).
 - Trifold disposable restraint (8465-01-514-8590).
 - Double-cuff disposable restraint (white [8465-01-515-1158] and black [8465-01-515-1156]).
- **Metal detectors.**
 - Super Scanner™ 0ELZ7 1165180 (6350-01-520-5942).
 - Metal detector (compact) 0ELZ7 1165900 (6350-01-520-5825).
- **Law enforcement frisk/search gloves.**
 - Size 7 (8415-01-505-2346).
 - Size 8 (8415-01-505-2347).
 - Size 9 (8415-01-505-2348).
 - Size 10 (8415-01-505-2350).
 - Size 11 (8415-01-505-2351).
 - Size 12 (8415-01-505-2352).
 - Size 13 (8415-01-505-2354).

CANTEENS

J-58. When directed by the CDO or a senior military police officer in the internment facility chain of command, canteens will be installed in the facility so that detainees can procure foodstuffs, soap, tobacco, and ordinary articles that are used daily. When authorized, canteens will be operated according to the GPW. Canteens will be installed in long-term internment facilities that normally intern docile detainees who not pose a significant security risk to themselves, other inmates, or the military police security force.

J-59. The tariff on items available to detainees will never exceed local market price. Procedures regarding detainee payment for canteen purchases are contained in DFAS-IN 37-1. Detainee representatives may make suggestions regarding the management of the canteen and the special fund.

J-60. Profits made by the facility canteen will be used for the benefit of detainees; a special fund will be created for this purpose. The special fund will benefit detainees of the same nationalities as those who contribute to it. When an internment facility is closed, the credit balance of the special fund will be turned over to another U.S. internment facility operating in the theater. When all canteen facilities close, commanders should consult the SJA regarding the remaining funds.

SPECIAL PROGRAMS

J-61. As a general policy, active education, visitation, employment, and agricultural programs for detainees are encouraged and supported. Adequate facilities, instructional material, and agricultural equipment will be provided for such activities as soon as practical.

EDUCATION PROGRAM

J-62. Education programs are developed according to DA policy guidance. Within the framework of this guidance and implementing directives issued by other responsible headquarters, a separate education program is developed for each internment facility. Each program must be developed to reflect the individual attitudes and political orientations of those interned in that facility. Factors and considerations that may influence education programs are—

- Various education levels throughout the detainee population.
- Detainee attitudes toward education and the education program.
- Requirements for essential and necessary detainee work details.
- Availability of qualified instructors, which may include—
 - Detainees.
 - Indigenous personnel.
 - U.S. armed forces and/or civilian personnel.
- Security considerations, which may restrict or prohibit the use of detainees or indigenous personnel.

J-63. In addition to an academic program, vocational training should be an integral part of the education program. The immediate objective of vocational training is to develop skills within the population that are immediately useful for full employment of detainees during internment. The long-range goal is to allow detainees to learn a trade that is transferable to civilian life.

VISITATION PROGRAM

J-64. Detention facility commanders should consider a visitation program for detainees. A visitation program can help maintain general detainee discipline. When planning a detainee visitation program, I/R commanders and staffs should establish procedures and policies to preclude the interaction of detainee visitors and U.S. or multinational personnel who conduct missions in the I/R facility.

EMPLOYMENT PROGRAM

J-65. Detainees constitute a significant labor force of skilled and unskilled individuals. These individuals should be employed to the fullest extent possible in work that is needed to construct, manage, perform administrative functions for, and maintain the internment facility. Per AR 190-8, detainees may be employed in other essential work only when other qualified civilian labor is not available. Detainee labor, external to the DOD, is regulated through contracts. For a complete discussion on employment and compensation for detainees, see AR 190-8.

J-66. The I/R battalion requires enough military police personnel to plan and supervise work details and to provide adequate guards to supervise detainees during work performance. Additionally, the I/R battalion requires adequate personnel to assist in the planning and coordination of facility maintenance requirements and to train and supervise detainees performing facility maintenance. This requirement includes the operation of engineer equipment, light road maintenance vehicles, and equipment to maintain the road network, fencing, and gray water management.

J-67. Commanders must organize and manage detainees in such a manner as to permit the proper and ready employment of each detainee. Consider—

- Establishing and maintaining a current occupational skill record for each detainee. Include new skills as they are acquired.
- Assigning individual detainees to a work detail or job on a regular or permanent basis.
- Establishing vocational training projects and encouraging detainees to study and develop needed skills to the maximum extent possible.

LABOR CONSIDERATIONS

J-68. Detainee labor may be used to perform the following:

- Camp administration and installation maintenance.
- Agricultural work.
- Public works, public utilities, and building operations that have no military character or purpose.
- Transportation and handling of stores that are not military in nature or purpose.
- Domestic services.

J-69. Certain labor restrictions apply when using detainee labor. These restrictions are as follows:

- An officer EPW may not be compelled to work.
- An NCO EPW can only be required to supervise the work of enlisted personnel.
- Detainees may not be compelled to engage in work that is purely military in nature and purpose.
- Detainees may not be employed on a labor detail that is unhealthy or dangerous because of the inherent nature of the work or the individual's lack of physical fitness or technical skill. GPW and AR 190-8 provide guidance on this type of employment.
- Detainees may not be assigned to labor that would be looked upon as humiliating or degrading for members of the U.S. armed forces. This prohibition has no effect on the performance of unpleasant, but necessary, tasks connected with the administration and maintenance of the internment facility.
- Detainees may not be employed or retained in an area where they may be exposed to the dangers of the POC.

J-70. In case of doubt as to whether certain work is authorized, the next higher headquarters SJA will review the proposed tasks to ensure that they are consistent with AR 190-8 and the law of war.

Restrictions

J-71. Detainees will not be employed in positions that require or permit—

- Access to classified defense information or records of other personnel.
- Access to telephones or other communication systems.
- Authority to command or instruct U.S. military personnel.

Paid Work

J-72. Detainees will be compensated for performing work for which pay is authorized. The rate of pay will not be less than that prescribed in the GPW. Compensation for all such work will be made as authorized from U.S. Army appropriated funds, canteen funds, or internment facility detainee funds. Only detainees with EPW, RP, or CI status are eligible for compensation (members of armed groups are not authorized compensation within the provisions of AR 190-8). Detainees are paid for various types of authorized work such as—

- Labor performed for a contract employer or federal agency.
- Services as orderlies and cooks for officer enemy combatants.
- Services to construct, administer, manage, and maintain internment facilities, branch facilities, and hospitals when such services are performed by enemy combatants permanently assigned to certain duties or occupations.

- Spiritual or medical duties required to be performed by RP for fellow detainees.
 - Service as a prisoner representative or assistant.
 - Work as detail leaders or interpreters.
-

Note. For a complete discussion on compensation for work by detainees see AR 190-8.

ADVANCE PAY

J-73. The GPW states that the detaining power will grant all prisoners of war a monthly pay advance, the amount of which will be fixed by conversion into the currency of the said power, in the following amounts:

- **Category I.** Detainees ranking below sergeant: 8 Swiss francs.
- **Category II.** Sergeants and other NCOs or detainees of equivalent grade: 12 Swiss francs.
- **Category III.** Warrant officers and commissioned officers below the grade of major or detainees of equivalent grade: 50 Swiss francs.
- **Category IV.** Majors, lieutenant colonels, colonels, or detainees of equivalent rank: 60 Swiss francs.
- **Category V.** General officers or detainees of equivalent grade: 75 Swiss francs.

J-74. The facility commander should consult with the SJA and financial management officer when setting up EPW advance pay accounts. The I/R battalion requires enough MOS 44C personnel to coordinate these activities with the supporting financial management unit.

AGRICULTURAL PROGRAM

J-75. Where practical, detainees will be required to raise vegetables for their use. This work is classified as paid work. Agricultural and gardening projects are particularly desirable because they provide gainful employment for large numbers of individuals. The food produced by the gardening projects provides a valuable supplement to detainee diets at a minimal expense. The produce from gardens is U.S. property. It will be used for the benefit of detainees and U.S. armed forces and will not be sold or traded in civilian markets.

J-76. The agricultural supplies required (seeds, fertilizers, implements) will be procured through local purchase or Army supply channels. The importance of developing an active agricultural program should not be overlooked, and care should be taken to order the necessary supplies in a timely manner.

This page intentionally left blank.

Appendix K

Psychological Operations Support to Internment and Resettlement Operations

Tactical PSYOP forces are capable of supporting all I/R operations, except the handling of U.S. military prisoners. The tactical PSYOP unit assigned to support an I/R operation will plan and conduct PSYOP in support of Army or joint task force operations in any mission environment across the spectrum of conflict. PSYOP personnel support units assigned to the I/R mission. The mission of the supporting PSYOP unit is twofold—to help maintain order within the facility and to provide the PSYOP task force or PSYOP support element with information relevant to the ongoing PSYOP programs.

OPERATIONAL PROCEDURES

K-1. Tactical PSYOP units provide the PSYOP task force and/or support element with a unique and useful capability by collecting timely PSYOP-relevant information from representatives of actual target audiences within an I/R facility. In addition, tactical PSYOP units provide the geographic combatant commander or joint task force commander with a valuable asset by executing PSYOP programs that pacify I/R facility populations. These programs assist the I/R facility guard force with control of the facility population during emergencies and intertheater transfers.

K-2. To effectively support I/R operations, tactical PSYOP units perform essential tasks that include—

- Developing a PSYOP program and conducting PSYOP to pacify, obtain cooperation from, and condition the I/R facility population to accept U.S. authority.
- Assisting the guard force control of I/R populations during emergencies and intercompound transfers.
- Collecting, analyzing, and reporting PSYOP-relevant intelligence. Examples of PSYOP-relevant intelligence includes, but are not limited to—
 - Identification of PSYOP vulnerabilities.
 - Indications of the effectiveness of themes, symbols, products, and current and previous PSYOP operations.
 - Verification of PSYOP targeting effectiveness (determine if PSYOP is reaching the intended target audience and if PSYOP operations are having collateral effects on intended or unintended target audiences).
- Testing PSYOP products as directed by the PSYOP task force or PSYOP support element.
- Developing and providing PSYOP products in support of PSYOP task force operations, such as recorded detainee surrender appeals.
- Collecting and confirming or denying demographic information about PSYOP target audiences.
- Ascertaining targets and objectives of propaganda.
- Determining the effectiveness of enemy internal propaganda, such as propaganda directed at opposing forces.
- Planning and conducting PSYOP to achieve other multinational and/or joint PSYOP task force or PSYOP support element objectives, such as reorienting or reeducating the I/R facility population or setting the stage for acceptance of future operations.
- Assisting in improving relations with the local population (in the vicinity of the I/R facility) to prevent or minimize interference with I/R facility operations.
- Conducting tactical PSYOP missions as directed by the PSYOP task force or support element, or the supported commander.

MISSION PLANNING

K-3. Since I/R operations vary greatly (including PSYOP support requirements), each mission must be planned and supporting units task-organized to meet the unique mission requirements. The basis for planning support to I/R operations is the tactical PSYOP detachment. One tactical PSYOP detachment of 16 personnel is capable of supporting an I/R facility operated by an I/R battalion with a maximum facility capacity of 4,000 compliant detainees or 8,000 DCs. The tactical PSYOP detachment assigned to support an I/R mission will task-organize internally to meet mission requirements. Normally, the tactical PYSOP detachment consists of tactical PSYOP teams that include—

- Interview team.
- Enclosure team.
- Quick-reaction force support team.
- Audiovisual team.

COORDINATION AND LINKUP

K-4. If possible, the tactical PSYOP detachment should deploy to the supported I/R facility during the construction phase. Arrival at the I/R facility during the construction phase ensures adequate time for the tactical PSYOP detachment to coordinate operating procedures, communications, and necessary sustainment support with the supported battalion and ensures that PSYOP considerations are included in I/R facility construction decisions. Early arrival also allows time to develop and produce the products necessary to support I/R facility operations, such as printed and recorded I/R facility rules in the language(s) of the facility population before the facility population arrives.

K-5. The tactical PSYOP detachment commander serves as the PSYOP staff officer for the I/R facility commander. The tactical PSYOP detachment commander is responsible for advising the I/R commander on the psychological impact of all actions inside and outside the I/R facility that may affect the facility population. This support is critical to prevent misunderstandings that may lead to disturbances by the facility population. Differences in culture, customs, language(s), religious practices, and dietary habits can be of such a magnitude that misunderstandings are not always completely avoidable. However, if I/R facility personnel follow the advice of the PSYOP officer, these situations may be minimized.

K-6. Upon arrival at the I/R facility, the tactical PSYOP detachment commander briefs the I/R battalion commander and subordinate enclosure commanders on the tactical PSYOP detachment mission and capabilities. The tactical PSYOP detachment commander or a designated representative attends all facility command and staff meetings. These meetings provide the most effective means to communicate on a daily basis with the facility commanders, their staffs, and other supporting units.

MISSION-SPECIFIC TRAINING

K-7. All PSYOP personnel must be familiar with the laws, regulations, and current policies governing the treatment of detainees and current doctrinal publications on detainee operations. Among these are—

- Law of war.
- Code of conduct.
- Geneva Conventions.
- AR 190-8.
- DODD 2310.01E.
- DODD 2311.01E.
- FM 27-10.
- FM 3-05.30.

K-8. All PSYOP personnel observe rules to validate the tactical PSYOP detachment's credibility with the I/R facility population and with I/R facility guards. Following these rules prevents embarrassing incidents that can be exploited by the enemy or bring discredit on the United States. These rules apply (and may be more important) when hostilities are not declared. Special rules apply for handling civilians during stability operations and civil support operations. PSYOP personnel should coordinate procedures for treating CIs and DCs with the facility commander and the SJA.

COMMAND INFORMATION AND PSYCHOLOGICAL OPERATIONS PRODUCT DISSEMINATION

K-9. The tactical PSYOP detachment conducts operations based on command information and PSYOP pacification programs using a variety of media. Music and news (from approved sources), I/R facility rules, and in-processing instructions are broadcast using facility loudspeaker systems augmented by loudspeaker systems organic to the tactical PSYOP detachment. If available, supporting audiovisual teams produce and disseminate audio and/or video products. Printed products will be produced by attached print teams or contracted print support, or through reachback capabilities. Products not directly related to I/R facility command information are subject to the PSYOP task force established approval process.

K-10. The Geneva Conventions and ARs require that all information presented to an I/R facility population be in the language of the facility's population. To facilitate this requirement, translators must be integrated into PSYOP (down to the team level). Translators must be able to address the I/R population in their native language and to screen products for language accuracy and content. U.S. or multinational forces, contracted civilians, or cooperative detainees may provide translator support. Tactical PSYOP detachment members must exercise caution to safeguard classified material and sensitive PSYOP task force operations at all times, especially in the presence of translators. Ideally, translators should be permanently attached to PSYOP teams so that they can be closely supervised and learn to function effectively within the PSYOP structure.

LOUDSPEAKER SUPPORT CONSIDERATIONS

K-11. The tactical PSYOP detachment commander should ensure that enclosure commanders include PSYOP loudspeaker support in activities involving mass transfers between facilities and other activities (health and welfare inspections) or in circumstances where a facility has the potential of becoming overcrowded. Limitations on resources available for I/R facility construction, combined with large surges of detainees arriving at the I/R facility, may result in temporary overcrowding. The potential for disturbances increases dramatically when I/R facilities are overcrowded.

TASK-ORGANIZED TEAM ROLES AND FUNCTIONS

K-12. The task organization of PSYOP teams is described in paragraph K-3. The roles and functions of these teams are further described below.

INTERVIEW TEAM

K-13. The interview team is comprised of tactical PSYOP detachment personnel who are trained to conduct interviews. If available, interview teams should be augmented with qualified MOS 97E interrogators to increase team effectiveness. The interview team normally operates in the I/R facility processing area, screening all or a representative sample of incoming detainees and DCs. Although MI units will likely be present in the facility, it is important for the interview team to maintain a separate operation. Nevertheless, the team must coordinate closely with MI personnel and other assets to obtain any PSYOP-relevant information gathered in interrogations and must provide information of intelligence value gained from passive collection by PSYOP personnel.

K-14. The team uses interview notes and database software to collect information about each detainee and DC. The data is compiled and forwarded to the tactical PSYOP detachment or support element or directly to the PSYOP task force for TA analysis. Information gained in PSYOP product pretests may be reported directly to the CONUS-based product development company to accelerate the product development and approval process. Information collected in PSYOP interviews should include the following information about detainees and DCs:

- Race or ethnicity.
- Sex.
- Age.
- Political affiliation.
- Religious affiliation.
- Geographic origin.

- Education level.
- Length, depth, and type of involvement during the conflict.
- Previous or current occupation.
- Standard of living and financial state.
- Previous military training.
- Political and military indoctrination.
- PSYOP vulnerability and susceptibility.

K-15. The initial interview, conducted on arrival at the I/R facility, should include a numerical score or code that indicates the desirability to conduct a follow-up interview as time and the situation permit. Detainees and DCs who are cooperative or possess information, skills, or characteristics of interest to the tactical PSYOP detachment should be interviewed in depth. The interview team specifically looks for—

- Malcontents, rabble-rousers, trained agitators, and political officers who may attempt to organize resistance or create disturbances within the I/R facility. Once these individuals are identified, guards will normally confine them in isolated enclosures to deny them access to the general population.
- Detainees and DCs willing to cooperate in setting up informant networks. These detainees and DCs should be referred to MI counterintelligence personnel, since as it is their responsibility to run informant networks within the I/R facility.
- Detainees and DCs with special skills who can assist with I/R facility operations. Such skills include language; construction; engineering; and training in medicine, education, and entertainment. Other skills may be useful based on the facility location and conditions.
- Detainees and DCs willing to assist with product development, such as taping audio surrender appeals.
- Detainees and DCs willing to participate in PSYOP product testing.

K-16. Access to members and former members of the designated PSYOP target audiences allows the interview team to conduct product testing that provides accurate, meaningful feedback to the PSYOP task force and product development company. Data collected during the surveys is passed to the PSYOP task force through the tactical PSYOP detachment and the PSYOP support element. The interview team must maintain secure, reliable communications with higher headquarters and ensure the timely, secure transport of product prototypes and testing results.

K-17. The interview team, along with other facility personnel, must take precautions to safeguard the identities of cooperative detainees and DCs to protect them from reprisals. PSYOP personnel must always exercise discretion when dealing with cooperative detainees and DCs. Guards must be thoroughly briefed on proper handling procedures.

K-18. Discovering detainees and DCs with false identities is an important security measure that can reduce potential problems and ensure smooth I/R facility operations. The interview team can discover false identities during initial processing or subsequent interviews. The team should look for—

- Documents that do not match.
- Interview responses that do not match those given during an earlier interview.
- Identification cards or tags that contradict other documents or information.
- Slow verbal responses to simple questions, such as a date of birth. The detainee or DC may be making up responses or trying to remember false information.
- Detainees and DCs without documentation. This situation requires careful investigation. For example, the detainee or DC may have thrown away their identification to avoid discovery.

- Detainees and DCs who suddenly refuse to cooperate at any point during processing.
- Names that appear in the list of sought after persons (sometimes called the “black list”).

ENCLOSURE TEAM

K-19. The tactical PSYOP detachment assigned as an enclosure team conducts face-to-face PSYOP and collects vital information within the I/R facility. To perform its mission, members of the enclosure team must have unrestricted access to the I/R population. The enclosure team conducts close coordination with the guard force commander to ensure that its activities do not jeopardize the safe operation of the I/R facility and to ensure that they are safe.

K-20. The enclosure team builds a rapport with detainees and DCs by distributing recreational equipment, conducting morale support activities, and performing other actions designed to gain the trust of detainees or DCs. Although it is important for the enclosure team to maintain close communication with other PSYOP team elements, such communication should be discreet and conducted away from the view of the I/R population. The enclosure team will usually enjoy a greater rapport with the I/R population if it is not identified with the authoritarian elements of the facility administration.

K-21. The enclosure team capitalizes on its access to the I/R population to collect information about individuals and to watch for potential problems. The enclosure team should look for—

- Formal and informal leaders.
- Individuals who are the center of attention in a group.
- Loners.
- Unusual groups.
- Items passed from one person to another.
- Contrasting soil in the compound.
- Lookouts.
- Signals and codes.
- Individuals who move from one group, to another and whose presence forces the topic of conversation to change.
- Individuals who speak for a group but maintain eye contact with another person in that group.
- Individuals who immediately make friends with military police guards.
- Detainees and DCs who express interest in I/R facility construction or materials and equipment used in facility construction.

QUICK-RESPONSE FORCE SUPPORT TEAM

K-22. In addition to providing loudspeaker support inside the facility, the tactical PSYOP detachment commander and quick-reaction force support team coordinate with enclosure commanders to include loudspeaker support to PSYOP as part of the I/R facility response capability. The quick-reaction force support team is a predesignated element that serves as an emergency tactical response force for the compounds or other locations determined by the facility commander.

K-23. The tactical PSYOP detachment commander maintains contact with the quick-reaction support force team through the supported unit’s communications network or by other means. The team designated to support the quick-reaction support force team must be prepared to support the quick-reaction force mission and should remain physically located with the quick-reaction support force team to facilitate a rapid response. The tactical PSYOP detachment commander or quick-reaction force support team leader must accomplish the following premission tasks:

- Brief the quick-reaction force commander on PSYOP capabilities and employment.
- Coordinate a reaction plan and preplanned routes with the quick-reaction force team.
- Rehearse operational procedures with each new quick-reaction force team.
- Rehearse likely emergency scenarios and perform reconnaissance of the sites.

- Prepare audio products and scripts to be used during likely scenarios.
- Ensure that translators are briefed and available if a translator is not attached to the quick-reaction force team.

AUDIOVISUAL TEAM

K-24. The audiovisual team can support three or more tactical PSYOP detachments when supporting I/R operations. The audiovisual team uses organic equipment to produce and disseminate products to the I/R facility population. The team supports the facility PSYOP program by disseminating entertainment products, such as videos and music. This team gives the tactical PSYOP detachment the ability to influence detainee and DC behavior by providing or withholding something of value to the population. When directed, the team disseminates products that support other PSYOP task force programs (reeducation, reorientation, posthostility themes).

K-25. At a minimum, the audiovisual team should have the capability to edit audio and video products in digital formats, provide edited audio products in compact disc and minidisc formats, disseminate video products in video home system and digital video disc formats, project video with sound to large audiences within the facility, record and edit digital still photographs, and print limited numbers of PSYOP products in various sizes for use within the internment facility.

Appendix L

Guidelines for Handling Evidence

This appendix provides general guidelines for handling captured materiel and documents that could be used as evidence in legal proceedings against captured persons suspected of crimes against humanity, terrorism, war crimes, and/or other crimes. Detailed procedures for identifying, handling, storing, transferring, releasing, and disposing of captured materiel and documents should follow accepted legal standards and should be documented in local regulations or SOPs.

EVIDENCE CUSTODY

L-1. Capturing units should report captured material and documents constituting evidence as soon as possible to military police or other personnel specially trained and authorized to handle evidence to ensure proper handling.

L-2. It is the responsibility of all military police Soldiers or other law enforcement personnel to take every precaution to preserve the integrity of evidence in its original condition. Evidence must be entered into the custodial system as soon as possible after its collection, seizure, or surrender.

L-3. The PM should establish and operate an evidence custodial system consisting of—

- Primary and alternate evidence custodian (designated, in writing by the PM).
- Evidence storage facilities.
- Evidence log.
- Active evidence custody record or file.
- Final evidence disposition record or file.

EVIDENCE RESPONSIBILITIES

L-4. Evidence custodian responsibilities cannot be further delegated. The evidence custodians should—

- Ensure that evidence is properly inventoried, tagged, packaged, and marked before acceptance for storage. DA Form 4137 should include the associated detainee's name, date of birth, rank and service number (if applicable), and an identifying number that connects the evidence to the detainee.
- Ensure that military police personnel who deliver the evidence for safekeeping properly complete DA Form 4137 before acceptance for storage.
- Properly safeguard evidence.
- Properly maintain the evidence log, active evidence custody record, and final evidence disposition files.
- Conduct inventories of evidence holdings regularly.
- Properly dispose of evidence.

SUBMISSION

L-5. The capturing unit completes DA Form 4137 and attaches it to captured materiel and documents. Required information provided on that form includes—

- National identifying letters of the capturing unit.
- Designation of the capturing unit, to include the branch of Service.
- Date-time group of capture.

Appendix L

- Location of capture, to include the eight-digit grid coordinates.
- Unit captured from (enemy or warring faction), to include national identifying letters as appropriate.
- Summary of capture circumstances.
- Associated captured person, if any.

L-6. The law enforcement person first assuming custody of evidence will subsequently mark it for future identification as evidence. If it is not possible to mark the evidence, it is put in a container that can be marked. The evidence is marked with the date-time group of acquisition and the rank and name of the person who assumed custody of it. When any person submits evidence to the evidence custodian, it will be properly tagged and placed in appropriate containers as necessary.

L-7. The evidence custodian will carefully examine, count, and weigh (as appropriate) all evidence being submitted. The submitting person must ensure that items being retained have some evidentiary value. The submitting person will promptly return or dispose of any items that do not have evidentiary value, according to authorized procedures.

L-8. The evidence custodian should not accept items that are not evidence nor accept evidence that is not properly tagged and accompanied by the stipulated documentation, such as DA Form 4137. Each item of evidence should have a case control number or an equivalent designator identifying the police report that pertains to the seized evidence.

STORAGE

L-9. Physically safeguard and store all evidence received in a separate, and distinct evidence room. The evidence room should be large enough for handling, storing, and processing volumes of evidence, consistent with the size of the law enforcement operation. It must also provide for the secure storage of evidence. When a room has been designated as an evidence room, other equipment and property (personal or official) will not be stored in it under any circumstances.

INVENTORY

L-10. When evidence is first received into custody by law enforcement personnel, whether confiscated during an investigation or received from a unit or command representative, the evidence custodian must personally inventory the evidence. Subsequently, when evidence is transferred between custodians for any reason, the evidence custodians must verify the inventory unless it has been placed in a sealed container by law enforcement personnel. Verify money and controlled substances even if they are in a sealed container. The evidence custodian and a disinterested officer (outside the PM office) will conduct the inventory. An entry is made in the evidence log reflecting the inventory and participating personnel.

TRANSFER AND SHIPMENT

L-11. When physical evidence in the possession of military law enforcement personnel is transferred or shipped to another agency, the chain of custody must be maintained. Ship by reliable and secure means, and maintain documentation to prove an unbroken chain of custody.

DISPOSAL

L-12. The evidence custodian will obtain approval for the final disposal of evidence from the proper authority and enter it on DA Form 4137.

L-13. Any evidence used in any court action will be retained until the initial trial and subsequent appeals are complete. Obtain authorization for disposal from the commander, appropriate legal officer, or a representative of either. Any evidence entered into the evidence custodial system that is not used in a judicial or administrative action may be disposed of upon authorization from the PM or a designated representative.

L-14. Evidence obtained during the course of an investigation that is the personal property of an individual will, when possible, be returned to that individual, with the exception of unlawful items. Examples of unlawful items include narcotics, unlawfully obtained drugs, illegal firearms, explosives, counterfeit currency, or counterfeit identification papers cards. When personal property is returned to the owner or an authorized representative, the individual receiving the property will be required to sign for it on DA Form 4137.

L-15. Evidence which, by its nature, cannot be returned to the owner or entered into a national supply system for disposal (narcotics, illegal firearms, other contraband) will be destroyed. This evidence will be destroyed by, or in the presence of, the evidence custodian and a staff NCO or commissioned officer assigned to the PM office. Destruction will be of a nature so as to make the evidence unusable for any lawful or unlawful purpose other than residual scrap.

This page intentionally left blank.

Appendix M

Biometrics

Biometrics are measurable physical and behavioral characteristics that enable the establishment and verification of an individual's identity. The term biometrics includes, but is not limited to, finger, face, hand, eye, voice, and DNA characteristics. Biometrics are integrated to achieve the management, protection, and control of identity information for friendly, neutral or unknown, and adversary personnel. This appendix provides an overview for the employment of biometrics and highlights them as key enablers in support of I/R operations.

OPERATIONS

M-1. A biometric is a measurable physical characteristic or personal behavioral trait used to recognize the identity or verify the claimed identity of an individual. *Biometrics* is the process of recognizing an individual based on measurable anatomical, physiological, and behavioral characteristics. (JP 2-0.)

M-2. Biometric terms (*recognition*, *verification*, and *identification*) are sometimes used interchangeably. This usage is not only confusing, but incorrect. Each term has a different, unambiguous meaning. The meaning of specific, biometric-related terms includes:

- **Recognition.** Recognition is a characteristic relating to the fundamental functions of identification or verification. Recognition is a generic term in the description of a specific biometric application (for example, facial or iris recognition). Recognition does not equate to verification.
- **Verification.** Verification is a task in which a biometric application confirms a subject's biometric sample by matching it against his stored biometric file. This is also known as *authentication*.
- **Identification.** Identification is a task in which a biometric application compares a submitted biometric sample against all of the biometric samples on file to determine whether it matches any of the samples within the database and, if so, provides the known identity of the biometric subject whose sample was matched. Identification is "closed set" if the person is known to exist in the database; it is an "open set" if the person is not known to exist in the database.

M-3. Biometric-enabled intelligence operations enhance military capabilities to dominate, protect, and manage individual identities. Current and emerging technologies continue to provide increased biometric capability for military police and military forces. Biometric technology can be leveraged to collect and maintain evidence for criminal investigation and subsequent prosecution. It can also be used to identify personnel for vetting, access, or other security or accountability requirements. This technology is also leveraged by HUMINT personnel within the MI community. There are two major types of biometric data that are especially useful to military police and HUMINT collectors. These are personal identification data (fingerprint, palm print) and other biological information (voiceprint, facial scan, retinal scan). This data is documented in databases that can be compared to identify the individual upon collection of biological data/evidence at a later date. Another type is biometric data that indicates source truthfulness (polygraph data). Polygraph evidence requires certified polygraph operators to administer and interpret the data.

M-4. Biometric-enabled intelligence operations integrate biometrics applications with operational and tactical missions to fulfill identified protection requirements. Several key activities are conducted when applying biometric technology. These activities are typically conducted independently of one another; however, they are all interconnected and interdependent. For example, an analyst at the strategic level may conduct analysis by querying databases and establishing linkages and patterns while at the tactical level, a

Soldier on a patrol may be collecting biometric data on individuals subsequent to a raid or criminal apprehension. All activities depend on each other for success. The activities include—

- **Collect.** Capture biometric and related contextual data from an individual, with or without his or her knowledge. Create and transmit a standardized, high-quality biometric file consisting of a biometric sample and contextual data, to a database for recording or matching.
- **Match.** Accurately identify or verify the identity of an individual by comparing a standardized biometric file to an existing source of standardized biometrics data and scoring the level of confidence of the match.
- **Store.** Enroll/input, update, and maintain biometric files to provide standardized, current biometric information of individuals when and where required. Biometrics files are enrolled or updated before they are stored.
- **Share.** Exchange standardized biometric files and match results among DOD, interagency, and multinational partners according to applicable laws and policies.
- **Analyze.** The analyze activity provides the answer to the “so what” question of all other activities. Link an individual’s biometric file with available associated information in an effort to identify patterns and linkages, clarify status, and better inform the decisionmaking process.
- **Reference.** Access databases of information on individuals for the purposes of analysis.
- **Decide/act.** Decide/act is the response by the operations owner (automated or human-in-the-loop) to the results of the analysis of biometrics and referenced associated information described in the DOD biometric process. Personnel reaching a conclusion and take action based on the analysis results of biometric data, combined with corroborating analysis or nonbiometric information on individuals.

ANALYSIS

M-5. Analysis is paramount biometrics-enabled operations. The analysis of biometric data fuses information obtained from biometric applications and information obtained from operational sources. It leverages both sources of information to increase situational understanding, create a holistic common operational picture, and better support the decisionmaking process. Analysis links individual biometric files (biometric samples and contextual data) to associated information to reveal patterns and clarify status.

COLLECTION

M-6. Collection begins with the user requirement to capture a biometric sample (finger, face, hand, eye, voice, or DNA prints) and related contextual data from an individual (with or without the individual’s knowledge) with a biometric collection system. A biometric collection system may be a manual or automated tool for measuring and evaluating a biometric for the purpose of human recognition. Contextual data are elements of biographical and situational information (who, what, when, where, how, why) that are associated with a collection event and permanently recorded as an integral component of the biometric file. Collection can occur at the point of contact with a target individual or as the result of biometric partners sharing biometric samples. The individual data sets that result from a collection action (biometric sample and contextual data) are referred to as a biometric file and are structured according to appropriate standards. The objective is to collect standardized, high-quality biometric files.

M-7. The execution of a collection action must be simple enough that any Service member, DOD civilian, or contractor can complete it with minimal training and equipment. Once a biometric sample and its contextual information are collected, thereby creating a standardized biometric file, the file is transmitted to the appropriate database for matching. The biometric source that receives the biometric file will acknowledge receipt of the transmitted biometric information.

DECISION

M-8. Decision is a fundamental component of successful biometric-enabled operations. A decision to act is the response by an analyst when the results of biometric analysis establish connections or linkages that support information requirements and decision points. The objective is to use biometrics to enable more

accurate decisionmaking when it is combined with other sources of information. Biometric data should be fused with nonbiometric data to ensure that a full picture and situational understanding is achieved.

MATCHING

M-9. Matching begins with the receipt of a collected, standardized biometric file. Matching is the process of accurately identifying or verifying the identity of an individual by comparing one or more standardized biometric files to existing biometric databases and scoring the level of confidence of the match by establishing multiple positive points of comparison. In some automated biometric applications, a user may be notified of a prompt, which refers to additional information available in databases of nonbiometric information on individuals. This notification can provide information or links to information that assist decisionmaking.

M-10. Matching consists of a one-to-one (verification) or one-to-many (identification) search. Verification and identification are described below:

- **Verification.** In the case of a closed set (one-to-one) match to verify an individual's claimed identity, the subject's biometric data is compared to known biometric data within the database. If the two samples/files match, the verification is confirmed. If the subject's biometric data is compared to known biometric data within the database and the samples do not match, verification cannot be confirmed. Typically, a verification decision is rendered by the computer. The result will be in the form of a "yes" or "no" decision associated with a specified level of confidence. A failure to verify means that the collected sample cannot be matched to any of the stored biometric samples within the biometric files. A verification means that the sample matches one or more stored biometric samples on a given individual.
- **Identification.** In the case of an open set (one-to-many) identification match, the computer may determine that there is no match, one match, or multiple match candidates. In some cases, the final decision may be rendered by a computer; in other cases, the final decision may be verified by a human expert. When multiple candidates are indicated by the computer, a human expert will typically be called upon to determine if there are zero, one, or multiple true matches. The result of the completed matching process is conveyed back to the search originator.

M-11. Once matching is complete, the collected biometric sample and contextual data are recorded into a database as a new biometric file or to update an existing biometric file. The database is updated with a new file every time a one-to-many match result is negative, except where restricted by laws or policies. An existing biometric file is updated every time an identification or verification match result is positive, except where limited by laws and policies.

REFERENCING

M-12. Referencing is integral to the successful analysis of biometrics data. It is the process of querying various databases of collected, associated information on individuals (intelligence, medical, human resources, financial, security, education, law enforcement) for the purpose of analysis. As described in paragraph L-5, associated information can, where applicable, be linked to a biometric file. This linkage can be placed within the biometric file in the form of a prompt and can occur outside of a collection event.

SHARING

M-13. Sharing is the exchange of biometric files (biometric samples, contextual data) or match results with other organizations. For the purpose of this manual, authorized sharing of biometric files among entities is applied as follows:

- Among DOD-approved sources to ensure consistency across the enterprise.
- Among DOD, interagency, and multinational partners, as appropriate.

STORING

M-14. Storing describes actions to enroll, maintain, and update biometric files within designated databases to support desired capabilities. The purpose is to provide standardized, comprehensive, and current biometric information on individuals where and when required.

M-15. Storage requirements can be as complex as a data megacenter or as simple as a laptop computer, depending on operational requirements and available technology. This appendix, therefore, accommodates three levels of biometric storage:

- An authoritative source is the primary database of biometric information on a person. The DOD may designate more than one authoritative source, consistent with applicable laws, policies, and directives. The authoritative source provides a strategic capability for accessing to standardized, comprehensive, and current biometric files within DOD and sharing of biometric files with joint, interagency, and designated multinational partners. Requisite connectivity is needed. All biometric files will be input into the appropriate authoritative source database at the earliest possible opportunity, except where limited by laws, policies, or directives. If there is no match, the biometric file is entered as a new enrollment within the database. If there is a match, the new information updates a current enrollment.
- A local trusted source is a subset of the authoritative source and is established to accomplish a specific requirement in support of a specific operational mission. The reasons for establishing a local trusted source might include insufficient network connectivity to provide immediate access to the authoritative source database or an operational need for closed-loop access. If a match is not made against a local trusted source database, then the file should be queried against the authoritative source database for a match.
- A local untrusted source is a local database of biometric files that has not been connected with an authoritative or local trusted source database. In many cases, local untrusted sources are established for short-duration missions or to satisfy political, policy, or legal restrictions related to the sharing of biometric information.

M-16. The authoritative databases and procedures for handling information on friendly forces are very different from the ways in which data on our adversaries are handled. By laws, regulations, and policies, DOD must manage these populations separately. The context and application of these authoritative sources and constraints on the use of data from these databases are distinct.

BIOMETRICS AUTOMATED TOOLSET

M-17. The Biometrics Automated Toolset is a suite of peer-to-peer enterprise network applications which consolidates an evolving set of biometric software and hardware that is capable of capturing, storing, and disseminating information and biometric data on threat personnel for the CI, HUMINT, military police, and MI communities.

M-18. The Biometrics Automated Toolset is designed with a peer-to-peer architecture that is networked over secure TCP/IP for maximum flexibility. The Biometrics Automated Toolset client and server can be installed on a single machine for a stand-alone configuration, or on separate machines that allow biometrics data to be collected in several field workstations and stored at a central server. The architecture also allows for Biometrics Automated Toolset data to be shared with integrated services, such as the Discovery and Synchronization Service which propagates new and updated records throughout a network of Biometrics Automated Toolset servers, Detainee Management System, and the Biometrics Registration Center that allows the remote tracking and setting of registrations and other Biometrics Automated Toolset settings in Biometrics Automated Toolset client machines. Biometrics Automated Toolset 4.0 also features data compatibility with the Detainee Reporting System, Handheld Interagency Identity Detection Equipment, Biometric Identification System for Access, and the human domain.

DETAINEE OPERATIONS

M-19. Detainees within a detention facility are a lucrative source of information. Detention facilities use the Biometrics Automated Toolset as the primary biometric collection and storage device. Biometrics data that is captured during collection can be rapidly searched and is continually accessible through an automated comparison process for new subject data files and access control. The recent employment of Biometrics Automated Toolset has generated a significant number of reports from information provided by the detainees within detention facilities, much of it corroborated by other intelligence reporting. This unprecedented body of information has expanded our understanding of terrorist organizations and continues

to prove invaluable. It has provided insights into their leadership structures, recruiting practices, funding mechanisms, and relationships; and the cooperation between terrorist groups and training programs; and plans for attacking the U.S. and other countries. Military police forces must leverage existing biometrics technologies to support the overall mission through enhanced situational understanding and support to the commander's decision cycle.

ENROLLMENT INTO THE DETAINEE REPORTING SYSTEM AND BIOMETRICS AUTOMATED TOOLSET

M-20. The in-processing into an internment facility is a two-part process. It involves enrollment into the Detainee Reporting System and Biometrics Automated Toolset Systems. Elements of detainee in-processing operations include the following—

- The process begins in a Secure Internet Protocol Router Biometrics Automated Toolset System to conduct an identity check. Based on the results of the identity check, a decision has to be made.
- The detainee may have been enrolled at a lower echelon prior to being transported to the next level internment facility, or he or she may have been previously enrolled into the biometric database.

DETAINEE REPORTING SYSTEM

M-21. The first task is to enroll the detainee into the Detainee Reporting System. The Detainee Reporting System will create an ISN that needs to be exported to the unclassified Biometrics Automated Toolset System where it will be imported as a text file into the enrollment wizard. As detainees are collected and processed, international laws require that such information be forwarded to the appropriate authorities. The NDRC is the executive agent designated by the OPMG as the recipient and archive for all detainee information.

M-22. The NDRC's principal responsibility is to ensure collection, storage, and appropriate dissemination of detainee information as required by AR 190-8 and DODD 2310.10E. The NDRC provides detainee information to the ICRC to fulfill U.S. obligations under the Geneva Conventions of 1956. The NDRC directs the development of the Detainee Reporting System. It issues blocks of ISNs to the TDRC.

DETAINEE TRACKING

M-23. Detainee tracking is a continual process, from capture to incarceration. The detainee tracking program is a web application that allows for the tracking of new detainees from the very first day of capture. This initiative was started by Marine Corps elements in Iraq. A web-based application that ties into the Biometrics Automated Toolset database allows the processing of individuals to determine their detention necessity. The detainee tracker was developed to address the specific needs of managing a transient population of temporarily detained individuals in short-term facilities (those where detainees are generally held for up to 14 days). It complements the Detainee Management System, which was developed to manage larger, long-term internment populations.

M-24. It is necessary to collect as much information as possible to determine whether detainee is to be released, detained locally for intelligence exploitation, or transferred to a facility for internment. This provides a basis and foundation of documentation that will follow the detainee from initial capture to final internment in a facility.

This page intentionally left blank.

Appendix N

Foreign Confinement Officer Training Program

This appendix addresses aspects of developing confinement officers in other countries. For the purposes of this appendix, the terms *foreign* and *HN confinement officers* are synonymous. Development of a training program begins with a discussion of the challenges involved and the resources required. This appendix provides a framework for organizing the development effort. Foreign confinement officer training is not always (or only) conducted in nations with ongoing insurgencies, but this appendix will focus on that scenario because it will be more challenging than providing support to HNs without ongoing or impending insurgencies.

CHALLENGES, RESOURCES, AND END STATE

N-1. Each instance of developing confinement officers will be as unique as the detention facility they will operate. Many factors influence the amount and type of aid required. These factors include—

- Capabilities of the current HN confinement officer force.
- Terrain.
- Level of commitment and sovereignty of the HN.
- Level of commitment from the United States and other nations.

N-2. While U.S. and multinational forces may be required to assist the HN in improving detainee operations, an insurgency will typically use the presence of foreign forces as another reason to question the legitimacy of the HN government. A government reliant on foreign forces for detainee operations runs the risk of not being recognized as legitimate. While combat operations with significant U.S./multinational participation may be necessary, U.S. combat operations are secondary to enabling HN ability to provide for its own competent and effective confinement officers.

CHALLENGES

N-3. There have been a number of common problems and issues in training missions undertaken by U.S. forces since the end of World War II. These problems generally fall under differing national perspectives in one of four broad categories:

- Resources.
- Leadership.
- Exercising power.
- Organizational structures.

Resources

N-4. Governments must properly balance national resources to meet the expectations of the people. Funding for services, education, and health care can limit the resources available for confinement officers and facilities. Undeveloped countries generally lack the resources to maintain sustainment units, resulting in chronic sustainment problems. Conducting effective I/R operations requires an allocation of resources that ensures the integration of efforts to develop all aspects of detainee operations. Recognizing the interrelationship of security and governance, the central HN government must also ensure that adequate resources are devoted to meeting such basic needs as health care, clean water, and electricity.

Leadership

N-5. The existing HN approach to leadership may need to be adjusted. HN leaders may be appointed and promoted on the basis of family ties or on the basis of membership in a party or faction, rather than on demonstrated competence or performance. Leaders may not seek to develop subordinates. The need to ensure the welfare of subordinates may not be a commonly shared trait. In some cases, leaders enforce the obedience of their subordinates by pure fear and use their position to exploit them. Positions of power can also lead to corruption, which may also be affected by local culture. The ultimate goal is to develop leaders at all levels who possess sound professional standards and appropriate military values, and are selected and promoted on the basis of competence and merit.

Exercising Power

N-6. The behavior of HN confinement personnel is often a primary cause of public dissatisfaction. The corrupting influences of power must be prevented. Cultural and ethnic differences within a population may lead to significant discrimination in the selection of confinement officers, which further contributes to discrimination against minority groups within the overall body of detainees. In more ideological struggles, the prejudicial treatment may be manifested against personnel of other political parties, whether in a minority cultural group or not. Confinement officers who abuse detainees do not win the trust and confidence of the population. A program of comprehensive confinement officer development requires identifying and addressing biases along with improper or corrupt practices.

Organizational Structures

N-7. Perhaps the biggest hurdle for U.S. forces to overcome is accepting that the HN may be able to ensure security using practices that work, but are different from established U.S. practices. The typical American bias of the “American way is best” must be recognized as unhelpful and continuously addressed. Training teams must be flexible in their approach and demonstrate the ability to incorporate successful local practices into the training. While the American relationship between police, customs, and the military works for the United States, it usually does not work for other nations that have developed differently. Variations in legal systems must be understood and applied for the training to be useful in each given situation.

RESOURCES

N-8. For the U.S. military, the mission of developing HN personnel, (in this case confinement officers), has grown to be more than just a task assigned to a few specialists. Training foreign forces is now a core competency of regular and reserve units of all Services. Multinational partners are often willing to help a nation fight insurgency by assisting with training HN forces even if they are reluctant to support other needs. Partner nations may develop joint training teams or assign teams to a specific element of the security force or a particular specialty. Training resources may be received from a number of organizations and programs, some of which are highlighted below.

Joint Forces

N-9. Although other Services normally play smaller roles than the Army, they can still make significant contributions because of their considerable experience in training their counterparts. The Navy, Air Force, and Marine Corps should be used, when possible, for training their HN counterparts. Standard joint practices should ensure that the training conducted by all Services is in concert with one another. In the case of confinement officer training, training teams may consist of trainers from more than one Service.

Interagency/Intergovernmental Resources

N-10. There are many legal restrictions about training nonmilitary forces, and the Department of State normally has the lead in such efforts. However, there have been occasions when military forces were assigned that mission by the President. U.S. military forces must be prepared to conduct HN training when required. Interagency resources can be applied in numerous ways to support the training of HN confinement officers. The Department of Justice also has the capability of sending corrections specialists overseas to train and advise HN

confinement officers, who are best trained by other police rather than military trainers. The quick-reaction capability of this agency is limited, although they can typically attain the necessary level of trainers when provided adequate time to do so. Select Department of Justice corrections specialists trainers to accomplish the mission is typically more expensive than the use of military trainers. During intensive counterinsurgencies, the effectiveness of civilian corrections advisers and trainers may be limited by the high-threat nature of the environment. These forces are most effective when operating in a benign environment or when separate security is provided for these trainers.

Multinational Resources

N-11. Although their support frequently plays a legitimizing role for U.S. efforts, multinational partners may also be willing to materially assist in training HN confinement officers. Some nations may be more willing to train HN forces than to provide troops for combat operations. Some multinational forces come with significant employment restrictions. Each international contribution is assessed on its own merits, but decisions to decline such assistance are rarely made. Good faith efforts to integrate multinational partners and achieve optimum effectiveness are required.

International Military Education and Training Program

N-12. For more than 50 years, the U.S. military has operated the International Military Education and Training program to provide opportunities for foreign personnel to attend U.S. military schools and courses. Most of these commissioned officers and NCOs are provided English language training before attending the U.S. courses. The United States does instruct courses in Spanish to support the training of Latin American (and other Spanishspeaking) armed forces. Competency in the language of the HN is critical for optimal training. While it is ideal for the actual trainer to possess the necessary language skills, this will often not be the case; and translator support is typically required.

Contract Support

N-13. In some cases, additional training support is contracted to enable uniformed forces to be more efficiently utilized. Contractor support can be used to provide HN training and education to include—

- Training personnel at the institutional level.
- Developing corrections systems.
- Establishing administrative and logistic systems.
- Providing translators.

U.S. Forces Organization

N-14. Developing HN confinement officers is a complex and challenging mission. The U.S. and multinational partners can only succeed if the mission is approached with the same deliberate planning and preparation, energetic execution, and appropriate resourcing as are combat aspects of the I/R operation. Accordingly, the joint force commander and staff consider potential requirements for developing HN confinement officers as part of their initial mission analysis. If required, this task becomes an integral part of all assessments, planning, coordination, and preparation.

N-15. As planning unfolds, mission requirements drive the initial organization for the unit charged with developing HN confinement officers. To achieve the unity of effort, a single military police headquarters should be given the overall responsibility for mission.

N-16. For large, multi-Service, long-duration missions, a separate organization which has the sole responsibility of developing confinement officers and that is subordinate to the joint force commander may be required. Such an organization may be multi-Service, multinational, and interagency.

N-17. The military police headquarters who is responsible for these programs requires adequate staffing to C2 of the functions required to support the development of HN confinement officers. In addition to traditional military police unit organic staff functions and capabilities, some or all of the following may be required augmentation:

- **Comptroller.** The comptroller, manages the significant monetary resources required for training, equipping, and building HN confinement officer forces. A separate internal auditor may be required check to ensure that HN resources are safeguarded and effectively managed.
- **SJA.** The SJA, with specific specialties and a robust capability for contract laws, military justice, and law of land warfare.
- **Construction engineer management.** Construction engineer management to oversee and manage the construction of necessary infrastructure, such as bases, ranges, and training areas, depots, and logistics facilities, and detainee facilities.
- **Political-military advisors.** Political-military advisers to ensure the integration of the development of confinement officers with the development of civilian ministries and capabilities.
- **Public affairs.** Public affairs, with a focused capability to build confidence of the population in their confinement officers and to develop the public affairs capabilities of the HN forces.
- **Antiterrorism and intelligence staff.** Antiterrorism and focused intelligence staff to address the challenge of and threats to the relatively small teams that may be embedded with HN detention facilities and not colocated with robust U.S. or partner forces or bases.
- **Materiel management.** Materiel management, until such a capability is developed in the HN forces. The equipping and sustaining of HN confinement officers and their equipment and facilities is critical to their development and employment. The HN may not be able to wait until their capability for materiel management is developed.
- **Health affairs.** Health affairs, since most developing countries have poor health care systems. HN personnel will be more likely to stay in new detention facilities if they are confident that they will receive proper medical treatment. Additionally, disease is a significant threat that must be addressed with preventive medicine and robust care.

N-18. An effective confinement officer training program is flexible and adaptive. The requirements for developing the type, character, composition, and quantity of HN confinement officers will be affected by the change and potential growth of HN detention facilities.

END STATE

N-19. To ensure long-term success, the end state of foreign confinement officer training programs must be clearly stated and understood at the beginning of the process. Necessary changes that occur during the process must be analyzed against the desired end state. A well-trained HN confinement officer force should—

- Be able to provide reasonable levels of internal security without infringing on citizen civil liberties or providing “fuel” that support insurgent rhetoric.
- Be founded upon the rule of law.
- Be sustainable by the HN after U.S. and multinational forces depart.

N-20. To achieve the end state and intermediate objectives, the HN should develop a plan with multinational assistance, when necessary, that holistically addresses all aspects of confinement officer development. U.S. doctrine divides force development into the domains of DOTMLPF. Doctrine is listed first, but these elements are tightly linked, simultaneously pursued, and difficult to prioritize. The commander who is responsible for the overall training monitors progress in all domains. There is always a temptation for Soldiers, Marines, and Airmen involved in such programs to impose their own doctrine and judgment on the HN. HN I/R doctrine, like the remaining DOTMLPF domains discussed throughout this appendix, must be appropriate to HN capabilities and requirements.

N-21. The objective of development programs is to create HN confinement officers with the following characteristics:

- Flexibility.
- Proficiency.
- Professionalism.
- Capability of working effectively in close coordination with other confinement officers.

- Competency in maintaining civil order, enforcing laws, and detaining criminal suspects.
- Modern police ethos training and procedures, to include a demonstrated understanding of the basics of investigation, evidence collection, and proper court and legal procedures.
- Capability of operating and maintaining necessary equipment.
- Honesty, impartiality, and commitment to protecting and serving the entire population, operating under the rule of law, and respecting human rights.
- Loyalty to the central government and serve national interests, recognizing their role as servants of the people and not their masters.

FRAMEWORK FOR DEVELOPMENT

N-22. A framework for the development of HN confinement officers training programs is essential and can generally be organized around these processes:

- Assess.
- Organize.
- Build.
- Train.
- Equip.
- Advise.

N-23. Each of these processes considers and incorporates all relevant DOTMLPF functions. Although described sequentially, some of these processes will actually be conducted concurrently. For example, training and equipping operations must be integrated, and as the operation progresses, assessments will lead to changes. A training program may also need to include a transition period during which major I/R operations are handed over to HN security forces if U.S. forces were required to establish a confinement system for the HN due to the collapse of governmental functions or if no viable system existed when U.S. trainers became involved.

ASSESS

N-24. As with every major military operation, the first step is to assess the situation. The assessment should be one part of the comprehensive program of analyzing the current situation, and it normally includes a social and economic analysis. From the assessment, planners develop short-, mid-, and long-range goals and programs. Those goals and programs must remain flexible enough to be responsive to changing circumstances. Some existing confinement officers might be discovered to be so dysfunctional or corrupt that they have to be removed rather than rehabilitated. In some cases, leaders may need to be replaced for successful training to occur.

N-25. The following indicators are continuously updated and assessed throughout the planning, preparation, and execution of the training mission:

- Structure of social values, organization, demographics, interrelationships, and education level of the confinement officer force.
- Methods, successes, and failures of HN I/R efforts.
- State of training at all levels and the specialties and education of leaders.
- Equipment status and the priority placed on maintenance.
- Sustainment and support structure and its ability to meet the requirements of the force.
- Level of sovereignty of the HN government.
- Extent of acceptance of ethnic and religious minorities and the role and treatment of women within the society.
- Laws and regulations governing the security forces and their relationship to national leaders.

N-26. The mission analysis should provide a basis for determining the scope of effort required for mission accomplishment. HN confinement officer programs may require complete reestablishment, or they may only require assistance to increase quality and/or capacity. They may be completely devoid of a capability, or they may only require temporary reinforcement. As with other military operations, efforts to assist confinement

officers should reinforce success. For example, instead of building new detention facilities in every town, improve the good facilities and use them as a model for weaker organizations.

ORGANIZE

N-27. The best organization for HN forces depends on the social and economic conditions of the country, and the cultural and historical factors and the security threat that the nation faces. The aim is to develop an effective and efficient organization with a C2, intelligence, logistic, and operational structure that makes sense for the HN. The organization must facilitate the collection, processing, and dissemination of intelligence across and throughout all detainee operations.

General Organizational Considerations

N-28. To the maximum extent possible, decisions on the structure of a confinement officer force organization should be made by the HN. The HN may be amenable to proposals from U.S. or multinational forces, but should at least approve all organizational designs. As the HN government gets stronger, U.S. leaders and trainers should expect increasingly independent organizational decisions. These may include changing the number of forces, types of units, and internal organizational designs. Culture and other shaping conditions may result in confinement officers performing what U.S. citizens might consider to be nontraditional roles and missions.

N-29. A thorough review of available HN military and police doctrine is a necessary first step in setting up a training program. Advisers should review corrections regulations to ensure that they provide clear and complete instructions for discipline, acquisitions, and support activities. Doctrine (including tactics, techniques, and procedures) should be reviewed and refined to address I/R operations. Regulations should be appropriate for the level of education and sophistication of confinement officer personnel. The treatment of DCs, detainees, and suspected persons should be spelled out clearly and be consistent with the norms of international and military laws.

Human Resources Issues

N-30. Organizing a confinement officer training program requires resolving human resources issues related to the areas of—

- Recruitment.
- Promotion screening/selection.
- Pay and benefits.
- Leader recruitment and selection.
- Personnel accountability.

Recruitment

N-31. Recruitment is critical to the establishment of a confinement officer training program. The recruitment program should be crafted by the HN and take local culture into account, using themes that resonate with the local population. It should ensure that all major demographic groups are properly represented in the confinement officers. U.S. and multinational partners should encourage and support HN efforts to recruit from among the minority populations. A mobile recruiting capability should be established to target specific areas, ethnic groups, or tribes to ensure demographic distribution within the body of confinement officers. Moderate groups and factions within hostile or potentially hostile ethnic groups should be contacted, and members of minority factions should be encouraged to support recruitment of their group members into the confinement officer training program. Recruitment of disaffected ethnic groups into the confinement officer training program will likely become a major issue of contention and be resisted by most HN governments. However, even moderate success in recruiting from disaffected ethnic groups provides an enormous payoff in terms of building the legitimacy of the confinement officers and in quieting the often legitimate fears of such ethnic groups regarding their relationship with the government. Cultural sensitivities toward the incorporation of women must be observed, but efforts should also be made to include women as correction officers.

N-32. A clear set of appropriate mental, physical, and moral standards needs to be established and enforced. Ideally, recruits are centrally screened and inducted. Recruitment centers need to be in areas that are safe and secure from insurgent attacks, as these centers are attractive targets for insurgents. All recruits undergo a basic security check and be vetted against lists of suspected insurgents. As much as possible, this process should be conducted by HN agencies and personnel. Membership in illegal organizations is carefully monitored. Past membership need not preclude joining the confinement officers, but any ongoing relationship of a recruit with an illegal organization needs constant monitoring. Ensure that no single group of confinement officers or a facility contains many prior members of an illegal unit, tribal militia, or other militant faction.

Promotion Screening/Selection

N-33. The selection for promotion based on proven performance and aptitude for increased responsibility is essential. Objective evaluations ensure that promotion is by merit, not through influence or family ties. Two methods may be worth considering for selecting leaders. One is to identify the most competent performers, train them, and recommend them for promotion. The second is to identify those with social or professional status within the training group, train them, and recommend them for promotion. The first method may lead to more competent leaders, but could be resisted for cultural reasons. The second method ensures that the new leader will be accepted culturally, but may sacrifice competence. The most effective solution is often a combination of the two methods.

Pay and Benefits

N-34. Appropriate compensation levels help prevent a culture of corruption in confinement officer forces. It is cheaper to spend money for adequate wages and produce effective confinement officers than it is to pay less and end up with corrupt and abusive forces that alienate the population. This is especially important for the police, who have the greatest opportunity for corruption in the nature of their duties and contact with the civilian community. Some important considerations concerning pay include the following:

- Pay for commissioned officers, NCOs, and technical specialists should be competitive with other professions in the HN. Confinement officers need to be paid a sufficient wage so that they are not required to supplement their income with part-time jobs or to resort to illegal methods to otherwise supplement their salary.
- Pay should be disbursed through HN government channels, not U.S. channels.
- Cultural norms should be addressed to ensure that any questionable practices, such as the “taxing” of subordinates, are minimized if not eliminated.
- Good pay and attractive benefits must be combined with a strict code of conduct that allows the immediate dismissal of corrupt confinement officers.
- Pensions should be available to compensate the families of confinement officers in the event of a service-related death.

N-35. Effective confinement officers can help improve the social and economic development of the nation through the benefits that each member receives. Every recruit should be provided a basic level of literacy, job training, and morals/values training.

Leader Recruitment and Selection

N-36. Leadership standards should be high. Candidates should be in good health and pass an academic test that is set to a higher standard than those for enlisted recruits. Officer candidates should be carefully vetted to ensure that they do not have close ties to any radical or insurgent organization. Those selected for leadership roles should already have demonstrated leadership potential.

Personnel Accountability

N-37. The accountability of confinement officer personnel must be carefully tracked. Proper personnel accountability reduces corruption, particularly in manual banking systems where pay is provided in cash. In addition, the number of personnel failing to report for duty can be an indicator of possible attacks, unit morale, or insurgent and militia influences upon the confinement officer forces.

Demobilization of Security Force Personnel

N-38. Programs should be developed to prevent the formation of a class of impoverished, disgruntled former confinement officers who have lost their livelihood. It may be necessary to remove officers from the detention facility for poor performance or for failure to meet the new, higher standards of the force. Some form of government-provided education grants or low-interest business loans will enable them to earn a living outside the military. Confinement officers who have served for several years and are then removed should be given a lump sum payment or a small pension to ease their transition to civilian life. These programs should not apply to those who are guilty of human rights abuses or major corruption.

BUILD

N-39. This process may be build and/or rebuild. Requirements include the infrastructure necessary to support the force: barracks, ranges, motor pools, and other military facilities. Because of the long lead times required for construction, early investment in such facilities is essential if they are to be available when needed. Any infrastructure design (including headquarters facilities) may attractive targets for insurgents, and protection considerations will be of critical importance. (See chapter 6 and appendix I for more information on facility design and sustainment considerations.)

N-40. During an insurgency, the HN confinement officers and police forces are likely to be operating from local bases. A long-term, force-basing plan needs to be established for building training centers and unit garrisons. If possible, garrisons should include government-provided medical care; housing for the commissioned officers, NCOs, enlisted, and families; and other amenities that make national service attractive.

N-41. The extensive investment of time and resources may be required to restore or create the infrastructure necessary to effectively train and use HN confinement officers. In addition to building I/R facilities and police stations, the HN will need functional regional and national headquarters and ministries.

TRAIN

N-42. U.S. and multinational training assistance should address shortfalls at every level with the purpose of establishing training systems that are self-sustaining. The ultimate goal is to replace U.S. or multinational trainers with HN trainers.

Training U.S. Trainers

N-43. Soldiers and Marines who are assigned training missions receive a course of preparation to deal with the specific requirements of developing the target HN confinement officers. The course should emphasize the cultural background of the HN, introduce its language (to include specific confinement-related terms and phrases) and provide insights into cultural tips for developing a good rapport with HN personnel. The course should also include protection training for those U.S. trainers focused on the specifics of working with the HN forces. U.S. trainees must become familiar with the HN organization and equipment, especially weapons not found in the U.S. inventory. Key points to be emphasized to U.S. trainers who support their training mission include, but are not limited to, the following:

- Ensure that training is sustained and includes reinforcement of individual and team skills.
- Use the smallest possible student-to-instructor ratio.
- Develop HN trainers who meet the specific requirements for the focused HN mission.
- Train so that standards—not time—are the driving factor.
- Provide immediate feedback; use after-action reviews.
- Respect HN culture, but be able to tell the difference between cultural practices and excuses.

N-44. U.S. personnel should show respect for local religions and traditions and willingly accept many aspects of the local/national culture, including the local food (if sanitation standards permit). U.S. personnel need to make it clear that they are not in the HN to undermine or change the local religion or traditions. On the other hand, U.S. personnel have a mission to reduce the effects of dysfunctional social practices that affect the ability to conduct effective I/R operations. U.S. trainers and advisers must have enough awareness to identify

inappropriate behavior and see that it is stopped or, at the very least, reported to the multinational and HN chains of command.

Establishing Training Standards

N-45. Effective training programs require the establishment of clear and detailed individual, leader, and unit performance standards, taking into account cultural factors that directly affect the ability of the individual or unit to operate. For example, training a group of confinement officers to conduct effective operations requires more time in a country where the average confinement officer is illiterate. Similarly, staff training is more difficult in a country with a low educational level. Building a force of confinement officers from scratch typically takes far more time than when there is a cadre of HN personnel already available. With this in mind, it is usually valuable to take advantage of existing military personnel with a basic understanding of discipline and organizational structure to form units and cadres for units, rather than starting from the beginning with raw recruits. As previously mentioned, a vetting process may be required, but this is still usually better than the alternative.

N-46. Poorly trained leaders and units are far more prone to human rights violations than well-trained, well-led units. Leaders and units unprepared for the pressure of active operations tend to employ indiscriminate force, target civilians, and abuse prisoners—all actions that can threaten the popular support and government legitimacy. Badly disciplined and poorly led confinement officers have served very effectively as recruiters and propagandists for the insurgents, rather than shining examples for the legitimate government.

N-47. The confinement officer training program must take into account the culture, resources, and short-term security needs of the HN. No firm rules exist on how long particular training programs should take, but previous or existing U.S. or multinational training programs can be considered as starting points for planning. To a certain extent, the insurgent threat may dictate how long training can take. As security improves, training programs can be expanded to facilitate longer-term end state goals.

Training Methods

N-48. Training programs are designed to prepare HN personnel to eventually train themselves. Indigenous trainers are the best trainers and should be used to the maximum extent possible. There are a number of possible training methods that have proven successful, many of which also enhance the development of HN training capability. These include—

- Formal schools operated by U.S. forces, with graduates selected to return as instructors. This includes entry-level individual training.
- Mobile training teams to reinforce individual or collective training on an as-needed basis.
- Partnership training, with U.S. combat units tasked to train and advise HN units with whom they are partnered. An military police unit provides support to the HN unit. As training progresses, HN squads, platoons, and companies may work with their U.S. military police partners in I/R operations. In this manner, the whole U.S. unit mentors their partners. Habitual training relationships should be maintained between partners until HN units meet established standards for full capability.
- Advanced partnership training with U.S. or international civilian policing and correctional organizations.
- Advisor teams detailed to assist HN units with minimal segregation between U.S. and HN personnel.
- Embedding U.S. personnel (initially) in key billets in HN detention facilities. This may be required where HN confinement officers are needed, but leader training is still in its early stages. This approach has the disadvantage of increasing dependency on U.S. forces and should only be used in extreme circumstances. As HN capabilities improve, their personnel should be moved back into those key positions.
- Selected use of contractors may also be used to assist with training, though care must be taken to ensure that the training is closely supervised and meets standards.

Soldier Training

N-49. Foreign confinement officers must be developed through a systematic training program that first builds their basic skills, then teaches them to work together as a team, and finally allows them to function as a unit. Confinement officers should train to standard for conducting the major missions that they will likely face. Requirements include, but are not limited to, the following:

- Managing their own security.
- Handling weapons.
- Employing special weapons.
- Providing escort/guard duties.
- Controlling riots.
- Providing effective personnel management.
- Conducting logistic (planning, maintenance, and movement) operations.
- Conducting police intelligence operations tasks.
- Handling and processing prisoners/detainees.
- Providing effective medical support.

N-50. Confinement officers should be trained to handle and interrogate detainees and prisoners according to internationally recognized human rights norms. Prisoner and detainee management procedures should provide for the security and fair and efficient processing of detainees.

N-51. I/R operations need effective support personnel to be effective. This requires training teams to ensure that training in support functions is established. Specially trained personnel required by confinement officers include the following:

- Armorers.
- Supply specialists.
- Communications specialists.
- Administrative specialists.
- Vehicle mechanics and other equipment and facility maintenance personnel.

N-52. Effective confinement operations are also linked to an effective justice system with trained judges, prosecutors, defense counsel, prison officials, and court personnel who can process arrests, detentions, warrants, and other judicial records. These elements are important components for establishing the rule of law.

N-53. Advisers should assist the HN in establishing and enforcing the roles and authority of the police. The authority to detain and interrogate, the procedures for detention facilities, and human rights standards are important items for instruction during this process.

Leader Training

N-54. The effectiveness of the confinement officer training program is directly related to the quality of their leadership. Building an effective leadership cadre requires a comprehensive program of officer, staff, and specialized training. The ultimate success of any U.S. involvement depends on the ability to create viable HN leadership that is capable of carrying on the mission at all levels and participating in the building of their nation without continued U.S. presence.

Operational Employment of Newly Trained Forces

N-55. Building the morale and confidence of confinement officers should be a primary strategic objective. Operational performance of inexperienced organizations should be carefully monitored and assessed so that weaknesses can be quickly corrected. The employment plan for HN confinement officers should allow considerable time for additional training. By gradually introducing units into I/R operations, poor leaders can be weeded out, while the most competent leaders are identified and given greater authority and responsibility.

EQUIP

N-56. The strategic plan for confinement officer development should outline requirements for appropriate HN equipment for the. Equipment should meet the specific needs and requirements of the HN. Equipment meets the standard when it is affordable and suitable against the given requirements and threats. The HN must also be able to train on the equipment. Interoperability may be a desired goal in some cases. A central consideration for equipment provided must be the HN's long-term ability to support and maintain the equipment.

N-57. The requirement to provide equipment may be as simple as assisting with existing equipment maintenance or as extensive as providing everything from shoes and clothing to vehicles, communications, and investigation kits.

N-58. Maintainability, ease of operation, and long-term sustainment costs should be primary considerations because few developing nations have the capability to support highly complex equipment. In I/R operations, it may be better to have a large number of versatile vehicles that are easy to maintain and operate than a few highly capable vehicles or systems that require extensive maintenance to keep operational. Developing an effective maintenance system for the HN may include a major maintenance program conducted by contracted firms to bring equipment up to functional standards. The program would then progress to partnership arrangements with U.S. forces as HN personnel are trained to carry out the support mission.

N-59. Sources for HN materiel include U.S. foreign military sales, multinational or third-nation resale of property, HN contracts with internal suppliers, or HN purchases on the international market. The HN should have the flexibility necessary to obtain equipment that meets the indigenous force needs for quality, timeliness, and cost.

ADVISE

N-60. Military police advisers that serve within HN detention facilities are a very prominent group. Advisers need to live, work and fight with their HN confinement officers, and keep segregation to an absolute minimum. The relationship developed between advisers and HN confinement officers is critical to success. U.S. leadership must be aware that these advisers are not just liaison officers, nor do they command HN units.

N-61. Effective advisers are an enormous force enhancer. The importance of the job means that the most capable individuals should be picked to fill these positions. Advisers should be Soldiers known to take the initiative and who set the standards for others. (See FM 3-05.202.)

N-62. More than anything else, professional knowledge and competence win the respect of HN confinement officers. Effective advisers develop a healthy rapport with HN personnel but avoid the temptation to adopt HN positions contrary to U.S. or multinational values or policy.

N-63. Advisers who understand the HN culture understand that local politics have national effects. It is important to recognize and employ the cultural factors that support HN commitment and teamwork. Part of the art of the good advisor is to employ the positive aspects of the local culture to get the best performance out of each confinement officer and leader.

N-64. Important guidelines for advisers are as follows:

- Learn enough of the language used by the HN to allow, at the very least, simple conversation.
- Be patient, adaptable, and subtle. In guiding counterparts, explain the benefits of an action and convince them to accept the idea as their own. Respect the rank and position of counterparts.
- Be diplomatic in correcting HN confinement officers. Praise each success, and work to instill pride in the unit.
- Understand that the U.S. advisory team is not the unit command team, but enablers. The HN commander must make decisions and command the unit, and military police are there to help with this task.
- Keep all counterparts informed, trying not to hide any agendas.
- Be prepared to act as a liaison to multinational assets, especially in the areas of maintenance and logistics.
- Maintain liaison with CA and humanitarian teams in the operational area and specific AOs.

Appendix N

- Stay integrated with the unit. Do not isolate yourself from them.
- Be aware of other operations so that fratricide is prevented.
- Insist on HN adherence to the recognized human rights standards concerning the treatment of DCs and detainees. Violations that are observed must be reported to the chain of command.

Glossary

The glossary lists acronyms/abbreviations and terms with Army or joint definitions, and other selected terms. Where Army and joint definitions are different, (Army) follows the term. Terms or acronyms for which FM 3-39.40 is the proponent manual (the authority) are marked with an asterisk (*).

SECTION I – ACRONYMS AND ABBREVIATIONS

5 S and T	search, silence, segregate, speed, safeguard, and tag
AFI	Air Force instruction
AJP	Allied joint publication (NATO)
AO	area of operations
AR	Army regulation
BCT	brigade combat team
C2	command and control
C-2X	coalition force human intelligence and counterintelligence staff element
CA	civil affairs
CBRN	chemical, biological, radiological, and nuclear
CBRNE	chemical, biological, radiological, nuclear, and high-yield explosives
CDO	commander, detainee operations
CI	civilian internee
CID	criminal investigation division
CJCS	Chairman of the Joint Chiefs of Staff
CJCSI	Chairman of the Joint Chiefs of Staff instruction
CONUS	continental United States
CTA	common table of allowances
DC	dislocated civilian
DA	Department of the Army
DCP	detainee collection point
DD	Department of Defense
DFAS-IN	Department of Finance and Accounting Service–Indiana
DHA	detainee holding area
DIAM	Defense Intelligence Agency manual
DNA	deoxyribonucleic acid
DOD	Department of Defense
DODD	Department of Defense directive
DODI	Department of Defense instruction
DOTMLPF	doctrine, organization, training, materiel, leadership and education, personnel, and facilities

EP	engineer publication
EPW	enemy prisoner of war
FBI	Federal Bureau of Investigation
FCF	field confinement facility
FDF	field detention facility
FM	field manual
FRAGO	fragmentary order
G-1	assistant chief of staff, personnel
G-2	assistant chief of staff, intelligence
G-2X	assistant chief of staff, human intelligence and counterintelligence
G-4	assistant chief of staff, logistics
G-9	assistant chief of staff, civil affairs operations
GC	Geneva Convention IV Relative to the Protection of Civilian Persons in Time of War
GPW	Geneva Convention III Relative to the Treatment of Prisoners of War
GWS	Geneva Convention I for the Amelioration of the Condition of the Wounded and Sick in Armed Forces in the Field
GS	general schedule
GWS SEA	Geneva Convention II for the Amelioration of the Condition of Wounded, Sick and Shipwrecked Members of Armed Forces at Sea
HIV	human immunodeficiency virus
HN	host nation
HUMINT	human intelligence
ICE	Immigration and Customs Enforcement
ICRC	International Committee of the Red Cross
IFRC	International Federation of the Red Cross
IO	international organization
I/R	internment and resettlement
ISN	internment serial number
J-2X	joint force human intelligence and counterintelligence staff element
JFTR	joint federal travel regulations
JIDC	joint interrogation and debriefing center
JP	joint publication
MCM	Manual for Courts-Martial
MEB	maneuver enhancement brigade
MI	military intelligence
MOS	military occupational specialty
MPC	military police command
MWD	military working dog
MTTP	multi-Service tactics, techniques, and procedures
NATO	North Atlantic Treaty Organization

NCO	noncommissioned officer
NDRC	National Detainee Reporting Center
NGO	nongovernmental organization
NLW	nonlethal weapon
OA	operation area
OCONUS	outside the continental United States
OE	operational environment
OPMG	Office of the Provost Marshal General
PM	provost marshal
PMG	Provost Marshal General
POC	point of capture
POW	prisoner of war
PSYOP	psychological operations
ROE	rules of engagement
ROI	rules of interaction
RP	retained personnel
RUF	rules for use of force
S-2X	human intelligence and counterintelligence staff officer
S-4	logistics staff officer
S-9	civil affairs staff officer
SF	standard form
SIF	strategic internment facility
SJA	staff judge advocate
SOP	standing operating procedure
STP	Soldier training publication
TB MED	technical bulletin, medical
TDRC	theater detainee reporting center
TIF	theater internment facility
UCMJ	Uniform Code of Military Justice
UN	United Nations
UNHCR	United Nations High Commissioner for Refugees
USC	U.S. Code

SECTION II – TERMS AND DEFINITIONS

***enemy prisoner of war**

A detained person who, while engaged in combat under orders of his or her government, was captured by the armed forces of the enemy.

***internment and resettlement operations**

Conducted by military police to shelter, sustain, guard, protect, and account for populations (detainees or dislocated civilians) as a result of military or civil conflict, natural or man-made disaster, or to facilitate criminal prosecution. Internment involves the detainment of a population or group that pose some level of threat to military operations. Resettlement involves the quartering of a population or group for their protection. These operations inherently control the movement and activities of their specific population for imperative reasons of security, safety, or intelligence gathering.

***[members of] armed groups**

Persons who engage in or support acts against the United States or its coalition partners in violation of the laws and customs of war during an armed conflict that do not meet the criteria of prisoners of war as defined within the Geneva Convention Relative to the Treatment of Prisoners of War.

***lawful enemy combatant**

A person entitled to protection under the Geneva Conventions, combatant immunity, and immunity from prosecution for lawful acts as a belligerent.

***U.S. military prisoner**

A person sentenced to confinement or death during a court-martial and ordered into confinement by a competent authority, whether or not the convening authority has approved the sentence.

References

SOURCES USED

These are the sources quoted or paraphrased in this publication.

ARMY PUBLICATIONS

- AR 15-6. *Procedures for Investigating Officers and Boards of Officers*. 2 October 2006.
- AR 20-1. *Inspector General Activities and Procedures*. 1 February 2007.
- AR 25-30. *The Army Publishing Program*. 27 March 2006.
- AR 40-5. *Preventive Medicine*. 25 May 2007.
- AR 40-66. *Medical Record Administration and Health Care Documentation*. 17 June 2008.
- AR 40-400. *Patient Administration*. 27 January 2010.
- AR 40-501. *Standards of Medical Fitness*. 14 December 2007.
- AR 190-8. *Enemy Prisoners of War, Retained Personnel, Civilian Internees and Other Detainees*. 1 October 1997.
- AR 190-14. *Carrying of Firearms and Use of Force for Law Enforcement and Security Duties*. 12 March 1993.
- AR 190-45. *Law Enforcement Reporting*. 30 March 2007.
- AR 190-47. *The Army Corrections System*. 15 June 2006.
- AR 195-2. *Criminal Investigation Activities*. 15 May 2009.
- AR 195-5. *Evidence Procedures*. 25 June 2007.
- AR 210-130. *Laundry and Dry Cleaning Operations*. 22 February 2005.
- AR 215-1. *Military Morale, Welfare, and Recreation Programs and Nonappropriated Funds Instrumentalities*. 31 July 2007.
- AR 600-20. *Army Command Policy*. 18 April 2008.
- AR 633-30. *Military Sentences to Confinement*. 28 February 1989.
- AR 700-84. *Issue and Sale of Personal Clothing*. 18 November 2004.
- AR 710-2. *Supply Policy Below the National Level*. 28 March 2008.
- AR 715-9. *Contractors Accompanying the Force*. 29 October 1999.
- DA Pamphlet 350-38. *Standards in Training Commission*. 13 May 2009.
- FM 1. *The Army*. 14 June 2005.
- FM 1-02. *Operational Terms and Graphics*, 21 September 2004.
- FM 1-06. *Financial Management Operations*. 21 September 2006.
- FM 2-22.3. *Human Intelligence Collector Operations*. 6 September 2006.
- FM 3-0. *Operations*. 27 February 2008.
- FM 3-05.202. *Special Forces Foreign Internal Defense Operations*. 2 February 2007.
- FM 3-05.30. *Psychological Operations*. 15 April 2005.
- FM 3-05.40. *Civil Affairs Operations*. 29 September 2006.
- FM 3-07. *Stability Operations*. 6 October 2008.
- FM 3-19.13. *Law Enforcement Investigations*. 10 January 2005.
- FM 3-19.15. *Civil Disturbance Operations*. 18 April 2005.
- FM 3-19.17. *Military Working Dogs*. 6 July 2005.

References

- FM 3-22.40. *Multiservice Tactics, Techniques, and Procedures (MTTP) for Tactical Employment of Nonlethal Weapons (NLW)*. 24 October 2007.
- FM 3-24. *Counterinsurgency*. 15 December 2006.
- FM 3-34.400. *General Engineering*. 9 December 2008.
- FM 3-39. *Military Police Operations*. 16 February 2010.
- FM 3-100.21. *Contractors on the Battlefield*. 3 January 2003.
- FM 4-02. *Force Health Protection in a Global Environment*. 13 February 2003.
- FM 4-02.1. *Combat Health Logistics*. 28 September 2001.
- FM 4-02.10. *Theater Hospitalization*. 3 January 2005.
- FM 4-02.12. *Health Service Support in Corps and Echelons Above Corps*. 2 February 2004.
- FM 4-02.17. *Preventive Medicine Services*. 28 August 2000.
- FM 4-02.18. *Veterinary Services Tactics, Techniques, and Procedures*. 30 December 2004.
- FM 4-02.19. *Dental Service Support Operations*. 21 July 2009.
- FM 4-02.2. *Medical Evacuation*. 8 May 2007.
- FM 4-02.21. *Division and Brigade Surgeons' Handbook (Digitized) Tactics, Techniques, and Procedures*. 15 November 2000.
- FM 4-02.25. *Employment Forward Surgical Teams Tactics, Techniques, and Procedures*. 28 March 2003.
- FM 4-02.283. *Treatment of Nuclear and Radiological Casualties*. 20 December 2001.
- FM 4-02.285. *Multiservice Tactics, Techniques, and Procedures for Treatment of Chemical Agent Casualties and Conventional Military Chemical Injuries*. 18 September 2007.
- FM 4-02.4. *Medical Platoon Leaders' Handbook Tactics, Techniques, and Procedures*. 24 August 2001.
- FM 4-02.43. *Force Health Protection Support for Army Special Operations Forces*. 27 November 2006.
- FM 4-02.51. *Combat and Operational Stress Control*. 6 July 2006.
- FM 4-02.56. *Army Medical Field Feeding Operations*. 29 April 2003.
- FM 4-02.6. *The Medical Company, Tactics, Techniques, and Procedures*. 1 August 2002.
- FM 4-02.7. *Multiservice Tactics, Techniques, and Procedures for Health Service Support in a Nuclear, Biological, and Chemical Environment*. 15 July 2009.
- FM 4-25.12. *Unit Field Sanitation Team*. 25 January 2002.
- FM 5-0. *Army Planning and Orders Production*. 20 January 2005.
- FM 5-34. *Engineer Field Data*. 19 July 2005.
- FM 5-415. *Fire-Fighting Operations*. 9 February 1999.
- FM 6-0. *Mission Command: Command and Control of Army Forces*. 11 August 2003.
- FM 7-15. *The Army Universal Task List*. 27 February 2009.
- FM 8-10-6. *Medical Evacuation in a Theater of Operations Tactics, Techniques, and Procedures*. 14 April 2000.
- FM 19-10. *The Military Police Law and Order Operations*. 30 September 1987.
- FM 21-10. *Field Hygiene and Sanitation*. 21 June 2000.
- FM 22-6. *Guard Duty*. 17 September 1971.
- FM 27-10. *The Law of Land Warfare*. 18 July 1956.
- FM 100-10-2. *Contracting Support on the Battlefield*. 4 August 1999.
- STP 19-31E1-SM. *Soldier's Manual, MOS 31E, Internment/Resettlement Specialist, Skill Level 1, Soldier's Manual*. 23 October 2007.

STP 19-31E24-SM-TG. *Soldier's Manual and Trainer's Guide, MOS 31E, Internment/Resettlement Specialist, Skill Levels 2/3/4*. 5 March 2009.

JOINT AND DEPARTMENT OF DEFENSE PUBLICATIONS

- AJP-2.5. *Captured Persons, Materiel and Documents*. August 2007.
- CJCSI 5810.01C. *Implementation of the DOD Law of War Program*. 31 January 2007.
- DIAM 58-12. *(S//NF) DOD HUMINT Management System (U)*. 30 June 1997.
- DODD 1325.04. *Confinement of Military Prisoners and Administration of Military Correctional Programs and Facilities*. 17 August 2001.
- DODD 2000.13. *Civil Affairs*. 27 June 1994.
- DODD 2310.01E. *The Department of Defense Detainee Program*. 5 September 2006.
- DODD 2311.01E. *DOD Law of War Program*. 9 May 2006.
- DODD 3000.3. *Policy for Non-Lethal Weapons*. 9 July 1996.
- DODD 3025.1. *Military Support to Civil Authorities (MSCA)*. 15 January 1993.
- DODD 3115.09. *DOD Intelligence Interrogations, Detainee Debriefings, and Tactical Questioning*. 9 October 2008.
- DODI 1100.22. *Guidance for Determining Workforce Mix*. 7 September 2006.
- DODI 1325.7. *Administration of Military Correctional Facilities and Clemency and Parole Authority*. 17 July 2001.
- DODI 3020.41. *Contractor Personnel Authorized to Accompany the U.S. Armed Forces*. 3 October 2005.
- DODI 6055.6. *DOD Fire and Emergency Services (F&ES) Program*. 21 December 2006.
- DODI 7000.14. *Department of Defense Financial Management Policy and Procedures*. 23 June 2006.
- JFTR Volume 1. *Uniformed Service Members*. Volume 1 of *Joint Federal Travel Regulations*. 1 September 2009. Available online at <http://www.defensetravel.dod.mil/perdiem/trvregs.html>.
- JFTR Volume 2. *Department of Defense Civilian Personnel*, Volume 1 of *Joint Federal Travel Regulations*. 1 September 2009. Available online at <http://www.defensetravel.dod.mil/perdiem/trvregs.html>.
- JP 1-02. *Department of Defense Dictionary of Military and Associated Terms*. 12 April 2001.
- JP 3-28. *Civil Support*. 14 September 2007.
- JP 3-34. *Joint Engineer Operations*. 12 February 2007.
- JP 3-57. *Civil-Military Operations*. 8 July 2008.
- JP 3-63. *Detainee Operations*. 30 May 2008.

OTHER PUBLICATIONS

- AFI 31-304. *Enemy Prisoners of War, Retained Personnel, Civilian Internees and Other Detainees*. 1 October 1997.
- Convention Against Torture and Other Cruel, Inhuman or Degrading Treatment or Punishment, Article 2*. 10 December 1984. Available online at <http://www2.ohchr.org/english/law/cat.htm#art2>.
- Convention Relating to the Status of Refugees*. 28 July 1951. Available online at <http://www.unhcr.org/protect/PROTECTION/3b66c2aa10.pdf>.
- CTA 50-900. *Clothing and Individual Equipment*. 20 November 2008.
- CTA 50-970. *Expendable/Durable Items (Except Medical, Class V, Repair Parts, and Heraldic Items)*. 28 January 2005.
- Defense Medical Standardization Board Web site. Available online at <http://www.jrcab.army.mil>.
- Detainee Treatment Act of 2005*. 30 December 2005.

References

- Executive Order 11850. *Renunciation of Certain Uses in War of Chemical Herbicides and Riot Control Agents*. 8 April 1975.
- Food and Nutrition Board, National Institute of Medicine Web site.
<<http://www.nal.usda.gov/fnic/etext/000105.html>>.
- Geneva Conventions. Available online at <<http://www.genevaconventions.org/>>.
- Geneva Conventions, Convention I, Common Article 3. 12 August 1949. Available online at <<http://www.genevaconventions.org/>>.
- Geneva Conventions, Convention I (GWS). *For the Amelioration of the Condition of Wounded, Sick and Shipwrecked Members of Armed Forces in the Field, Geneva, 12 August 1949*. Available online at <<http://www.genevaconventions.org/>>.
- Geneva Convention Convention II (GWS SEA). *For the Amelioration of the Condition of Wounded, Sick and Shipwrecked Members of Armed Forces at Sea, Geneva, 12 August 1949*. Available online at <<http://www.genevaconventions.org/>>.
- Geneva Conventions, Convention III (GPW). *Relative to the Treatment of Prisoners of War, Geneva, 12 August 1949*. Available online at <<http://www.genevaconventions.org/>>.
- Geneva Conventions, Convention IV (GCP). *Relative to the Protection of Civilian Persons, 12 August 1949*. Available online at <<http://www.genevaconventions.org/>>.
- Hague Conventions. Available online at <http://hcch.e-vision.nl/index_en.php?act=conventions.listing>.
- MCM. *Manual for Courts-Martial United States*. 2008. Available online at <<http://www.au.af.mil/au/awc/awcgate/law/mcm.pdf>>.
- Military Medical Ethics Volume I and Volume II*. Available online at <<http://www.bordeninstitute.army.mil/>>.
- Geneva Conventions, Protocol I. *Additional to the Geneva Convention of 12 August 1949, and Relating to the Protection of Victims of International Armed Conflict, 8 June 1977*. Available online at <http://www.genevaconventions.org/>.
- Geneva Conventions, Protocol II. *Additional to the Geneva Convention of 12 August 1949, and Relating to the Protection of Victims of Non-International Armed Conflicts, 8 June 1977*. Available online at <http://www.genevaconventions.org/>.
- Protocol Relating to the Status of Refugees*. 4 October 1967.
- Public Law 106-523. *Military Extraterritorial Jurisdiction Act of 2000*. 22 November 2000. Available online at <http://frwebgate.access.gpo.gov/cgi-bin/getdoc.cgi?dbname=106_cong_public_laws&docid=f:publ523.106.pdf>.
- TB MED 530. *Occupational and Environmental Health Food Sanitation*. 30 October 2002.
- UCMJ. *Uniform Code of Military Justice*. Available online at <<http://www.au.af.mil/au/awc/awcgate/ucmj.htm>>.
- War Crimes Act*. 1996. Available online at <<http://thomas.loc.gov/cgi-bin/query/z?c104:H.R.3680>>.
- DFAS-IN 37-1. *Finance and Accounting Policy Implementation*. Available online at <<http://asafm.army.mil/offices/BU/Dfas371.aspx?OfficeCode=1200>>.
- EP 1105-3-1. *Base Camp Development in the Theater of Operations*. 19 January 2009. Available online at <<http://140.194.76.129/publications/eng-pamphlets/ep1105-3-1/toc.pdf>>.
- 10 USC. *Armed Forces*.
- 18 USC, Sec 1385. *Use of Army and Air Force as Posse Comitatus*.
- 22 USC, Sec 2151. *Congressional findings and declaration of policy (Foreign Assistance Act)*.
- 32 USC. *National Guard*.
- 42 USC Chap 68. *Disaster Relief (Robert T. Stafford Relief and Emergency Act)*.
- UNHCR Handbook for Emergencies*. Third Edition, February 2007. Available online at <http://www.the-ecentre.net/resources/e_library/doc/ThirdEdition.pdf>.

UNHCR Handbook for the Military on Humanitarian Operations, First Edition. 1 January 1995.
Available online at <<http://www.unhcr.org/3d5122884.html>>.

Universal Declaration of Human Rights. 10 December 1948. Available online at
<http://ddsn.sc.gov/providers/manualsandguidelines/Documents/Human_RightsCommittee/7.Universal%20Declaration%20of%20Human%20Rights.pdf>.

DOCUMENTS NEEDED

These documents must be available to the intended users of this publication. DA forms are available on the Army Publishing Directorate Web site <www.apd.army.mil>.

- DA Form 31. *Request and Authority for Leave (EGA)*.
- DA Form 1124. *Individual Receipt Voucher Personal Deposit Fund*.
- DA Form 1125-R. *Summary Receipt and Disbursement Voucher Personal Fund (LRA)*.
- DA Form 1128. *Petty Cash Voucher–Personal Deposit Fund*.
- DA Form 1129-R. *Record of Prisoners’ Personal Deposit Fund (LRA)*.
- DA Form 1134-R. *Request for Withdrawal of Personal Property (LRA)*.
- DA Form 1135-R. *Personal Property Permit (LRA)*.
- DA Form 1594. *Daily Staff Journal or Duty Officer’s Log*.
- DA Form 2028. *Recommended Changes to Publications and Blank Forms*.
- DA Form 2662-R. *United States Army EPW Identity Card (LRA)*.
- DA Form 2663-R. *Fingerprint Card (LRA)*.
- DA Form 2664-R. *Weight Register (Prisoner of War) (LRA)*.
- DA Form 2665-R. *Capture Card for Prisoner of War (LRA)*.
- DA Form 2666-R. *Prisoner of War Notification of Address (LRA)*.
- DA Form 2667-R. *Prisoner of War Mail (Letter) (LRA)*.
- DA Form 2668. *Prisoner of War Mail (Post Card)*.
- DA Form 2669. *Certificate of Death*.
- DA Form 2670-R. *Mixed Medical Commission Certificate for EPW (LRA)*.
- DA Form 2671-R. *Certificate of Direct Repatriation for EPW (LRA)*.
- DA Form 2672-R. *Classification Questionnaire for Officer Retained Personnel (LRA)*.
- DA Form 2673-R. *Classification Questionnaire for Enlisted Retained Personnel (LRA)*.
- DA Form 2674-R. *Enemy Prisoner of War/Civilian Internee Strength Report (LRA)*.
- DA Form 2675-R. *Certification of Work Incurred Injury or Disability (LRA)*.
- DA Form 2677-R. *United States Army Civilian Internee Identity Card (LRA)*.
- DA Form 2678-R. *Civilian Internee Natl-Internment Card (LRA)*.
- DA Form 2679-R. *Civilian Internee Letter (LRA)*.
- DA Form 2680-R. *Civilian Internee Natl-Post Card (LRA)*.
- DA Form 2823. *Sworn Statement*.
- DA Form 3078. *Personal Clothing Request*.
- DA Form 3955. *Change of Address and Directory Card*.
- DA Form 3997. *Military Police Desk Blotter*.
- DA Form 4137. *Evidence/Property Custody Document*.
- DA Form 4237-R. *Detainee Personnel Record (LRA)*.
- DA Form 4459. *Parole Action Record*.
- DA Form 5162-R. *Routine Food Establishment Inspection Report (LRA)*.
- DA Form 5456. *Water Point Inspection*.

References

DA Form 5457. *Potable Water Container Inspection.*
DA Form 5458. *Shower/Decontamination Point Inspection.*
DA Form 5513. *Key Control Register and Inventory.*
DD Form 2. *Armed Forces of the United States Geneva Convention Identification Card.*
DD Form 214. *Certificate of Release or Discharge from Active Duty.*
DD Form 499. *Prisoner's Mail and Correspondence Record.*
DD Form 503. *Medical Examiner's Report.*
DD Form 504. *Request and Receipt for Health and Comfort Supplies.*
DD Form 506. *Daily Strength Record of Prisoners.*
DD Form 509. *Inspection Record of Prisoner in Segregation.*
DD Form 510. *Request for Interview.*
DD Form 515. *Roster of Prisoners.*
DD Form 1131. *Cash Collection Voucher.*
DD Form 1380. *U.S. Field Medical Card.*
DD Form 2064. *Certificate of Death Overseas.*
DD Form 2707. *Confinement Order.*
DD Form 2708. *Receipt for Inmate or Detained Person.*
DD Form 2710. *Inmate Background Summary.*
DD Form 2711-1. *Custody Reclassification.*
DD Form 2712. *Inmate Work and Training Evaluation.*
DD Form 2713. *Inmate Observation Report.*
DD Form 2714. *Inmate Disciplinary Report.*
DD Form 2715-3. *Inmate Restoration/Return to Duty, Clemency and Parole Statement.*
DD Form 2716. *Parole Acknowledgement Letter.*
DD Form 2716-1. *Department of Defense Certificate of Parole.*
DD Form 2718. *Inmate's Release Order.*
DD Form 2745. *Enemy Prisoner of War (EPW) Capture Tag.*
DD Form 2A. *Active Duty Military Identification Card.*
SF 558. *Medical Record—Emergency Care and Treatment.*
SF 600. *Medical Record—Chronological Record of Medical Care.*
SF 1402. *Certificate of Appointment.*

READINGS RECOMMENDED

These sources contain relevant supplemental information.

ARMY PUBLICATIONS

AR 15-130. *Army Clemency and Parole Board.* 23 October 1998.
AR 25-400-2. *The Army Records Information Management System (ARIMS).* 2 October 2007.
AR 40-3. *Medical, Dental, and Veterinary Care.* 22 February 2008.
AR 190-12. *Military Working Dog Program.* 4 June 2007.
AR 385-10. *The Army Safety Program.* 23 August 2007.

JOINT AND DEPARTMENT OF DEFENSE PUBLICATIONS

DODD 5100.46. *Foreign Disaster Relief.* 4 December 1975.
DODI 2310.08E. *Medical Program Support for Detainee Operations.* 6 June 2006.

OTHER PUBLICATIONS

Congressional Research Service Report for Congress. *Treatment of "Battlefield Detainees" in the War on Terrorism*, Congressional Research Service, the Library of Congress. 11 April 2002.

Available online at <<http://www.coherentbabble.com/CRS/CRS-RL31367-11-06.pdf>>.

Executive Order 12148. *Federal Emergency Management*. 20 July 1979.

National Response Framework. 22 March 2008. Available online at

<<http://www.fema.gov/emergency/nrf/>>.

This page intentionally left blank.

Index

A

Army Corrections System, 9-1

B

battlefield facilities, 7-2

FCFs, 7-3

FDFs, 7-2

biometric-enabled intelligence,
M-1

boards, 9-8

C

CA

activities, 10-5

personnel, 3-16, 10-1

support, 10-2

transportation of DCs, 10-8

CDO

responsibilities, 3-4

chaplains, 1-6, 3-14, 5-11, 6-37, 7-6

children

detainee processing, 4-12

processing, 1-11

unaccompanied, 10-10, 10-15

under the age of 15, 10-13

under the age of 18, 10-15

CI

clothing, J-16

definition, 1-5

civil support

definition, 2-8

civilian organizations, 1-12

types, 1-13

confinement

definition, 1-2

contractors, C-1

expectations of, C-4

international agreements,
C-3

management, C-2

policy, C-3

training considerations, C-3

counterinsurgency

definition, 2-4

counterintelligence, 3-16

crowd, H-9

dynamics, H-8

crowd tactics

control measures, H-6

crowds, H-9

D

DC

definition.

DCPs, 6-4

location, 6-6

medical support, 6-9

planning, 6-6

security, 6-9

DCs

exercise, D-4

refugees, 1-11

subcategories, 1-7

treatment policy, 1-11

detainee

clothing, J-16

definition, 1-5

detainee operations, 4-1

planning considerations, 5-2

Detainee Reporting System, 6-15,

detainees, 1-5

abuse, I-2

activities, 8-1

basic standard of care, D-2

categories, 1-5

clothing, D-3

correspondence, 8-1

deaths, 5-13

evacuation, 6-7

exercise, D-4

false identities, K-4

food rations, D-2, J-11

full processing, 6-24

general protection and care,
1-10

health, J-11

humane treatment, D-2

hygiene facilities, D-3

immunizations, I-7

impounded items, 4-14

internment, 6-14

interrogations, 5-3

mail, D-4

medical and dental care, D-3

medical monitoring, I-8

medical support, 5-6

medications, I-9

movement, 4-15

personnel file, 5-14

photographing, I-8

processing, 4-5

property, 4-12, D-3

releases, 1-16, 4-19, 5-15,
6-38

religion, D-3, D-4

representation, 5-10, D-4

retained items, 4-13

screening, I-7

shelter, D-3

special programs, 5-22, J-19

status determination, 1-8

transfers, 1-16, 5-15, 6-38

treatment, I-2

treatment policy, 1-10

water, D-3

detention facility commander,
9-5, 9-6, 9-8

DHA, 6-10

location, 6-11

medical support, 6-14

operating units, 6-10

planning considerations, 6-12

security, 6-14

displaced person definition, 1-7

disposition boards, 8-2

E

emergency medical treatment,
I-5, I-7, I-9

EMT.

enemy combatant

definition, 1-6

engineer support, 10-6, J-1

EPW

clothing, J-16

EPWs

determination of status, 1-7

escapes, 3-17, 5-16, 6-14, 6-33, H-3

evacuee definition, 1-7

evidence custodial system, L-1

evidence custodian, L-1, L-2

expellee

definition, 1-7

external agency involvement,
1-12

F

facility commanders, 8-7

FCF, 7-3

alarms, 7-12

commander, 7-7

construction, 7-3
 emergency plans, 7-11
 facility guards, 7-8
 location, 7-3
 reaction force, 7-11
 shift supervisor, 7-8
 use of force, 7-12
 FDF, 7-2
 FDFs, 7-2
 Federal Emergency
 Management Agency, E-1
 field hygiene, I-12
 food service personnel, 10-13,
 I-11, J-11, J-12
G
 Geneva Conventions, 9-8
 guard, 3-6
 force, 3-18
 towers, J-8
H
 humane treatment, 1-3, 1-10,
 1-11, 5-16, 6-3, D-1, I-1
 humanitarian assistance
 domestic, E-3
 foreign, E-1
 UN, E-3
 humanitarian-assistance, 10-9
 forces, E-3
 HUMINT, 1-15
 collectors, 3-6, 3-7, 3-8, 5-3,
 5-5, 6-8, 6-13, C-4
I
 I/R facilities, J-5
 generators, J-9
 infirmary, J-12
 sanitation, J-13
 site selection, J-5
 I/R facility construction
 minimum requirements, J-6
 pedestrian entrance (sally
 port), J-8
 site selection, J-5
 towers, J-8
 I/R facility service
 requirements, J-10
 I/R operations, 1-1
 accountability, 1-4
 care, custody, and control,
 1-4
 close contact, 1-4
 commanders responsibility,
 3-3
 evacuation, 1-14
 humane treatment, 1-3
 military police support
 organizations, 3-10

minimum force, 1-4
 nongovernmental agencies,
 E-1
 planning, 1-14
 reporting agencies, 3-1
 segregation, 1-4
 U.S. military prisoner
 operations, 7-1
 I/R populations, 1-5
 IG, 3-15
 indigenous penal system, 9-11
 inmate classification, 8-2
 intelligence, 3-12
 internally displaced person
 definition, 1-7
 internment facilities, H-7
 construction phase, K-2
 construction requirements,
 J-4
 disciplinary punishment, 6-
 30
 internment facility, 5-10
 interpreter, 3-7, 4-11, 4-15, 6-
 20, I-5, J-14
 ISN, 1-15, 4-12, 5-14, 5-15, 6-
 7, 6-15
J
 juvenile, 9-11
L
 labor, I-7, J-19
 availability, 6-3
 considerations, J-20
 pay, 3-14
 policy, 3-13
 requirements, 3-14
 restrictions, J-20
 linguists, 6-26
 logistical support, 5-2, 7-2, J-1,
 J-5, J-6
M
 medical officer, 9-5
 medical support, 5-6, 5-20, 6-3,
 6-35, I-1, I-2, I-7
 DCPs, I-6
 restrictions, I-2
 medical surveillance, I-8
 medical treatment facilities, I-6
 Level II, I-6
 Level III, I-6
 migrant
 definition, 1-7
 military decisionmaking
 process.
 military police companies, 3-11

MPC, 2-8, 3-10
 MWDs, 5-3, 5-5, 6-9, 6-33, I-11
N
 NDRC, 1-12, 3-1, 5-14, 5-15,
 6-15, 6-24
 NGOs, 1-13
O
 operational environment, 1-1
 hostile, 2-7
 operations officer, 3-12, 6-17,
 6-37
P
 PAO, 1-16, 3-15
 parole board, 9-1, 9-3, 9-4
 penal program, 9-11
 penal system template, 9-10
 personal hygiene, I-12
 pest management, I-11
 PM, 3-12
 POC, 2-9
 protected person
 definition, 1-5
 PSYOP, 3-16, K-1
 access to, K-4
 enclosure team, K-5
 interview team, K-3
 loudspeaker support, K-3
 quick-reaction force support
 team, K-5
 public affairs officer, 9-5
Q
 quick-reaction force teams, H-
 6, H-7, H-8, K-5
R
 reaction force, 7-11
 refugee
 definition, 1-7
 refugees, E-3
 rights, 1-11
 rehabilitation program, 8-9
 resettlement facilities
 civilian involvement, 10-15
 ROI, 10-16
 RUF, 10-16
 resettlement operations, 10-1,
 10-2, 10-8, 10-10
 DCs, 10-11
 planning, 10-6, 10-12
 support, 10-9
 restraints
 use of, 5-18

review boards, 8-2

riots, H-6

ROI, 5-19, 6-28

RP, 1-5

clothing, J-16

definition, 1-5

privileges, 1-6

RUF, 1-14, 7-3, H-3

resettlement, 10-16

S

searching devices, J-18

security forces, 5-17, 6-17, 10-16, J-9

security measures, 3-11, 3-18, 6-9, 6-31, 6-32, 6-38, 7-7, 7-8, 7-11, B-3, I-6

SIF, 6-37

HUMINT support, 6-38

location, 6-37

medical operations, 6-38

planning considerations, 6-37

records and reports, 6-38

security considerations, 6-38

transfers or releases, 6-38

SJA, 3-13, 9-5

socialization, 8-12

stateless person

definition, 1-7

supply, 7-11

accountability, 7-11

physical inventories, 7-11

support

personnel, 7-10

support units

MPC, 2-8

sustainment support, K-2

T

tactical psychological operations detachment.

TDRC, 1-12

technical channels

definition, 2-8

TIF, 6-17

emergency action plans, 6-28

location, 6-19

operations, 6-26

planning considerations, 6-19

records and reports, 6-26

transport protective system, J-18

batons, J-18

frisk/search gloves, J-18

handcuffs, J-18

metal detectors, J-18

U

U.S. Army Corrections

Command

mission, 3-3

U.S. military prisoners, 1-7, 7-3

classification, 7-4

clothing, 7-5

correspondence, 7-10

custody guidelines, 7-7

facilities, 7-1

food, 7-5

identification, 7-4

operation planning process, 7-1

operation principles, 7-1

operations, 7-1

personal property, 7-10

processing, 7-3

treatment policy, 1-11

UN, 1-12, 1-13

use of force, H-2

NLWs, H-4

W

work details, 6-33

This page intentionally left blank.

FM 3-39.40
12 February 2010

By order of the Secretary of the Army:

GEORGE W. CASEY, JR.
General, United States Army
Chief of Staff

Official:



JOYCE E. MORROW
Administrative Assistant to the
Secretary of the Army
1002201

DISTRIBUTION:

Active Army, Army National Guard, and United States Army Reserve: To be distributed in accordance with the initial distribution number (IDN) 115851, requirements for FM 3-39.40.

