



U.S. Immigration
and Customs
Enforcement

Information Sharing Status

Enforcement Systems Branch

February 23, 2011



- **DHS INFORMATION SHARING VISION STATEMENT**

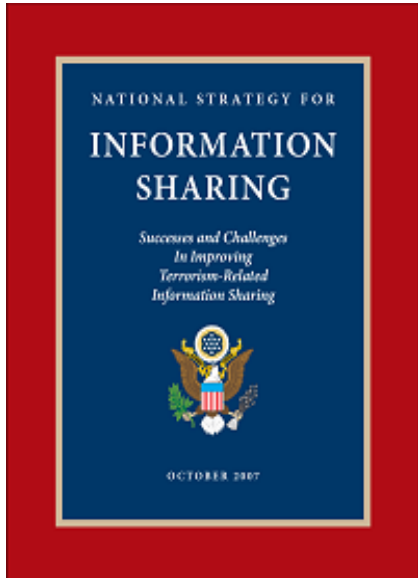

- *By September 30, 2015, DHS will transform the Department's culture, policies, and architecture (e.g., processes, standards, and technologies) to enable the consistent successful execution of the five core homeland security missions and further mature and strengthen the homeland security enterprise's information sharing environment to ensure that the right information gets to the right people at the right time, while protecting privacy, civil rights, and civil liberties.*

- **DHS LEISI VISION STATEMENT**

- *DHS LEISI will enable an agile environment for sharing DHS Law Enforcement Information, thereby increasing the security and safety of the Homeland.*



- **Recent Agreements**
 - Law Enforcement Information Exchange (LInX) National Capital Region (NCR)
 - National Drug Pointer Index System (NDPIX)
 - International Justice and Public Safety Network (Nlets)
 - National Counterterrorism center (NCTC) – Arrival and Departure Information System (ADIS)
 - NCTC – Electronic System for Travel Authorization (ESTA)
 - LInX Hampton Roads
 - Law Enforcement National Data Exchange (N-DEX)
 - Southern California LInX (So Cal LInX)
- **Special Projects**
 - National Drug Pointer Index (NDPIX)
 - Organized Crime Drug Enforcement Task Force (OCDETF)
 - El Paso Intelligence Center (EPIC)
 - TECS Supplemental Codes
 - National Counterterrorism Center (NCTC)

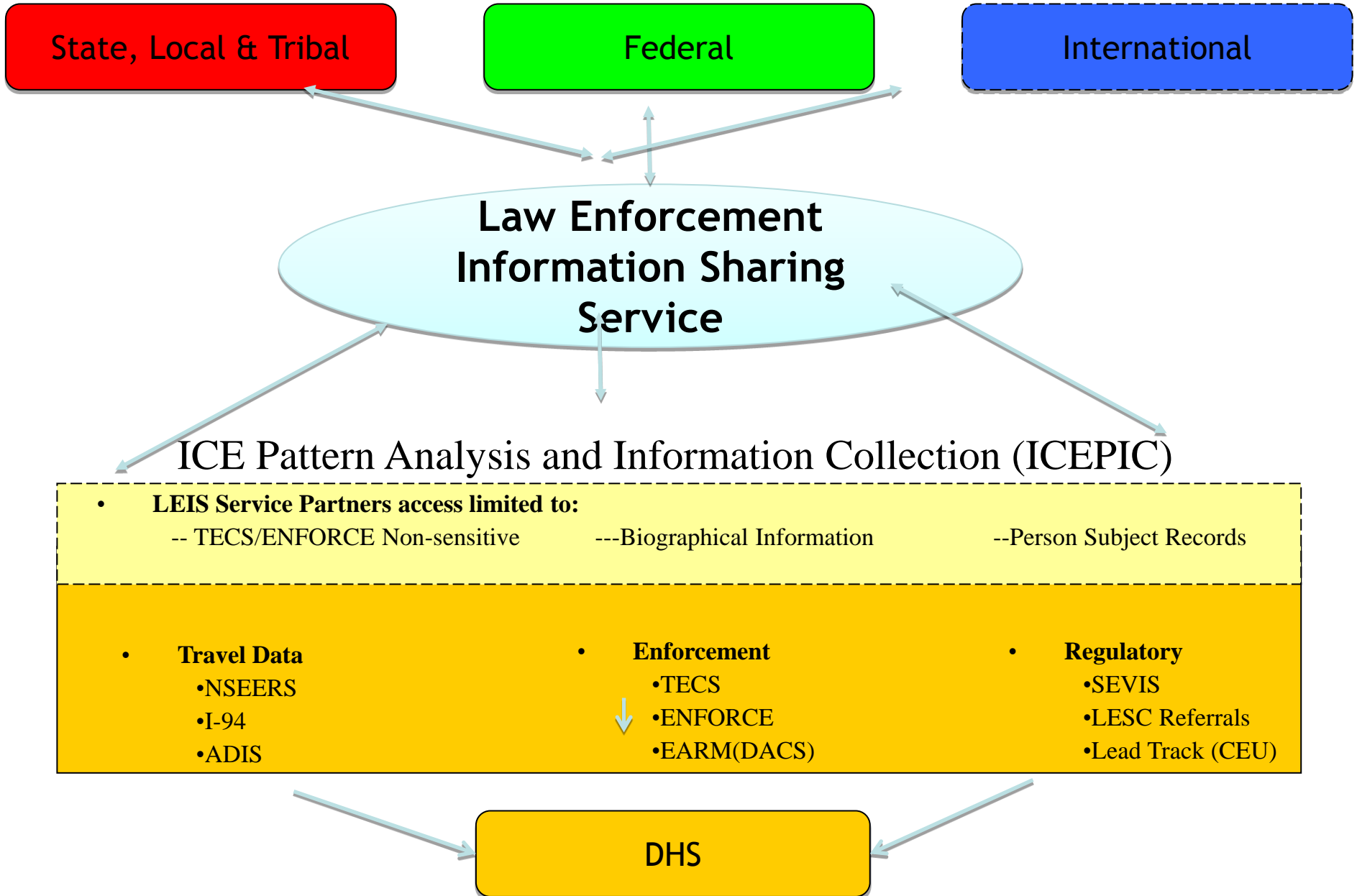



State and
Local



Federal

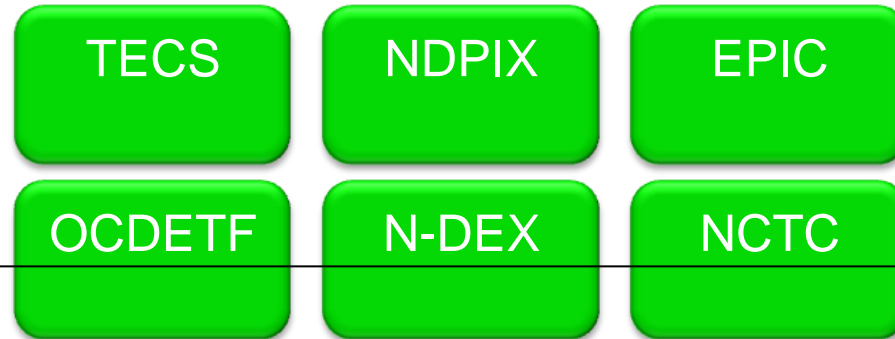

International

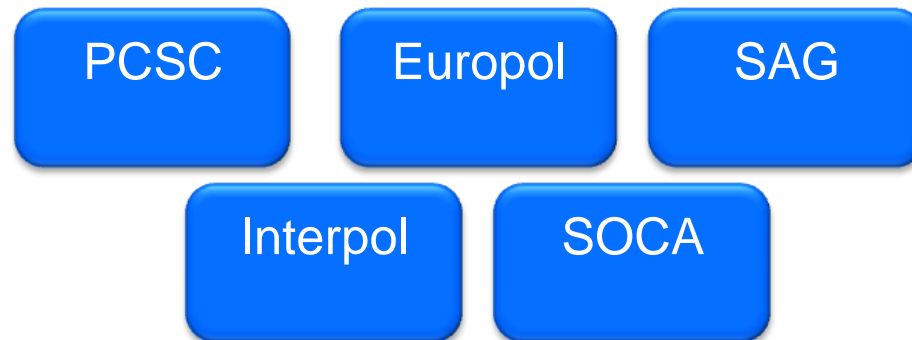

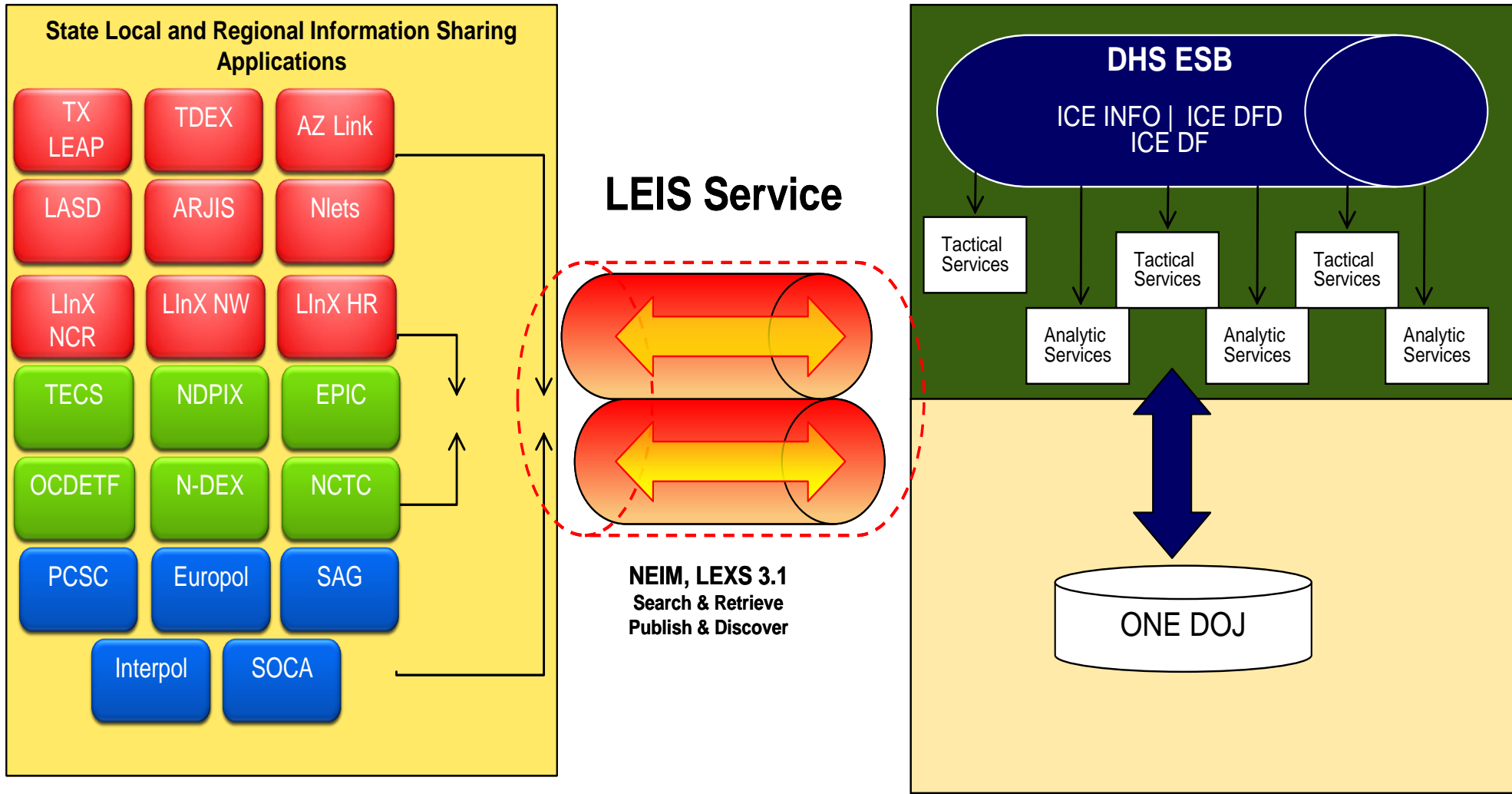



Search History

This chart represents the number of searches against ICEPIC within the past 6 months.

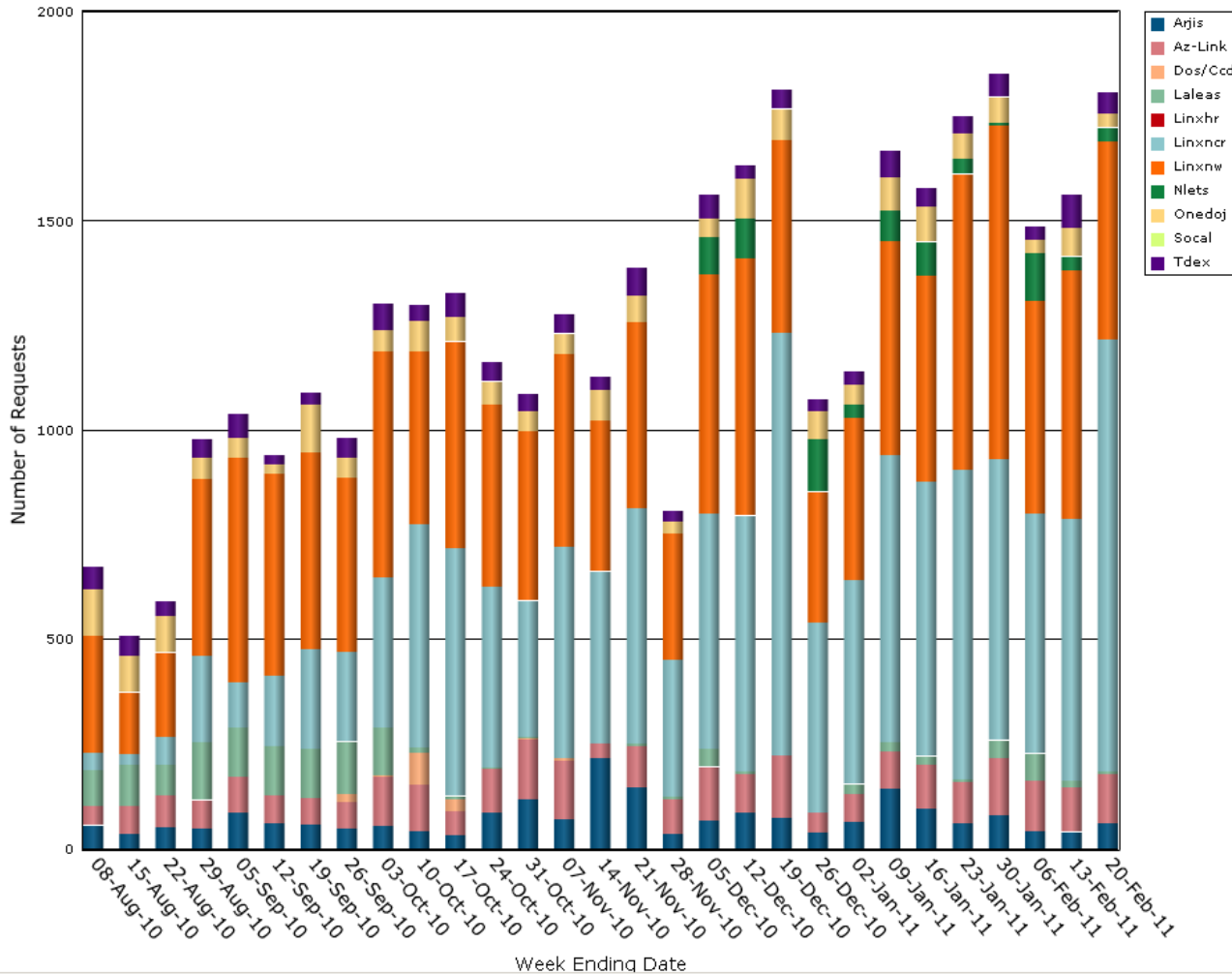

Six Month Search Summary

Client	Search Count
ARJIS	2,089
AZ-LINK	2,685
DOS/CCD	141
ICEPIC	15,051
LALEAS	1,283
LINXNCR	13,221
LINXNW	13,225
NLETS	714
ONEDOJ	1,811
T-DEX	1,316
report total:	51,536

Six Month Fetch Summary

Client	Search Count
ARJIS	5,555
AZ-LINK	6,925
DOS/CCD	76
ICEPIC	17,509
LALEAS	2,553
LINXNCR	3,309
LINXNW	3,815
NLETS	37
ONEDOJ	582
T-DEX	1,030
report total:	41,391

Increase of over 200% since August 2011!



Search History

This chart represents the number of search requests for different web services within the past 6 months.

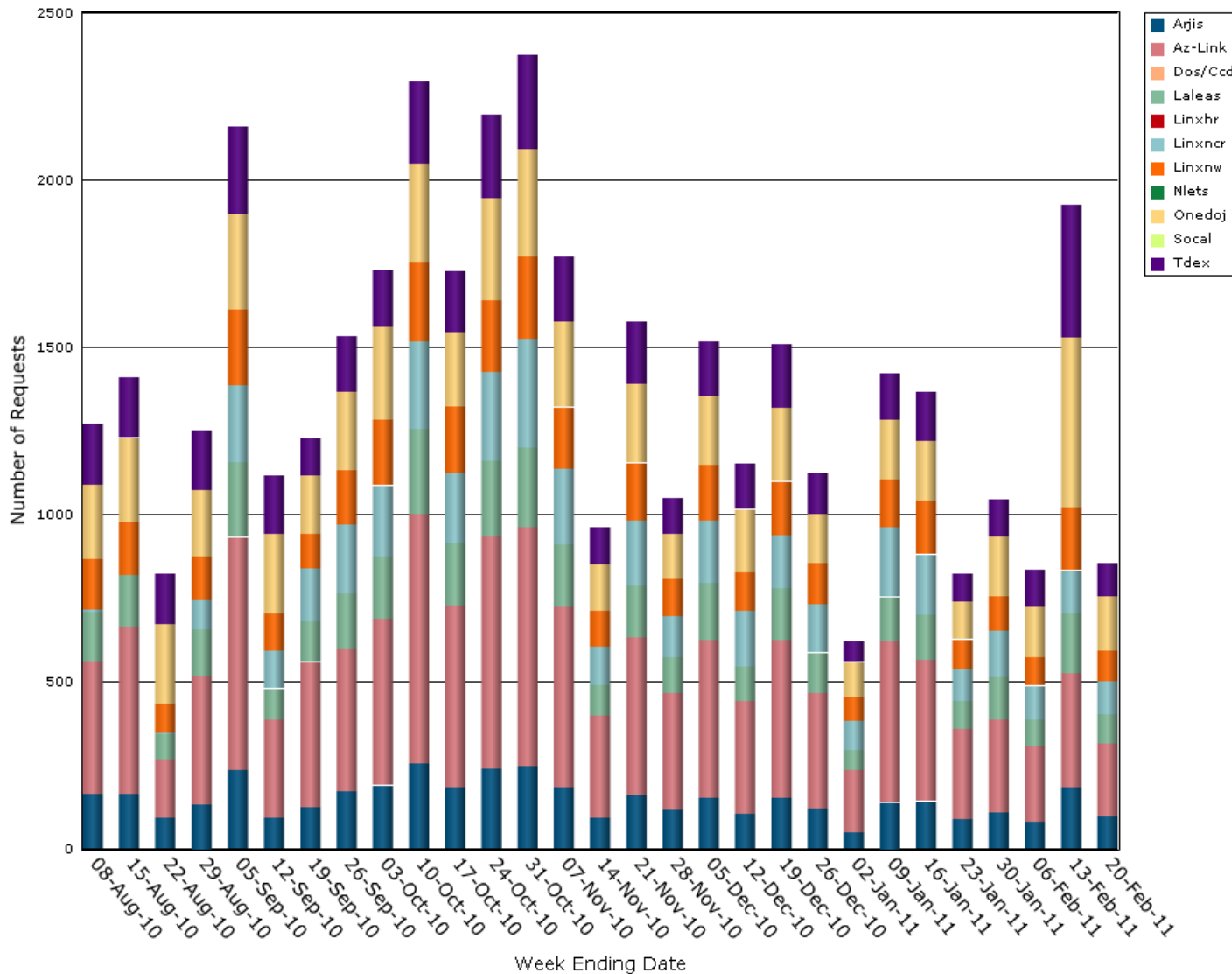

Six Month Search Summary

Destination	Search Count
ARJIS	4,244
AZ-LINK	12,216
LALEAS	4,179
LINXHR	7
LINXNCR	4,446
LINXNRW	4,290
ONEDOJ	6,380
T-DEX	4,888
report total:	40,650

Six Month Fetch Summary

Destination	Search Count
ARJIS	511
AZ-LINK	413
LALEAS	156
LINXHR	3
LINXNCR	2,192
LINXNRW	822
ONEDOJ	468
T-DEX	902
report total:	5,467

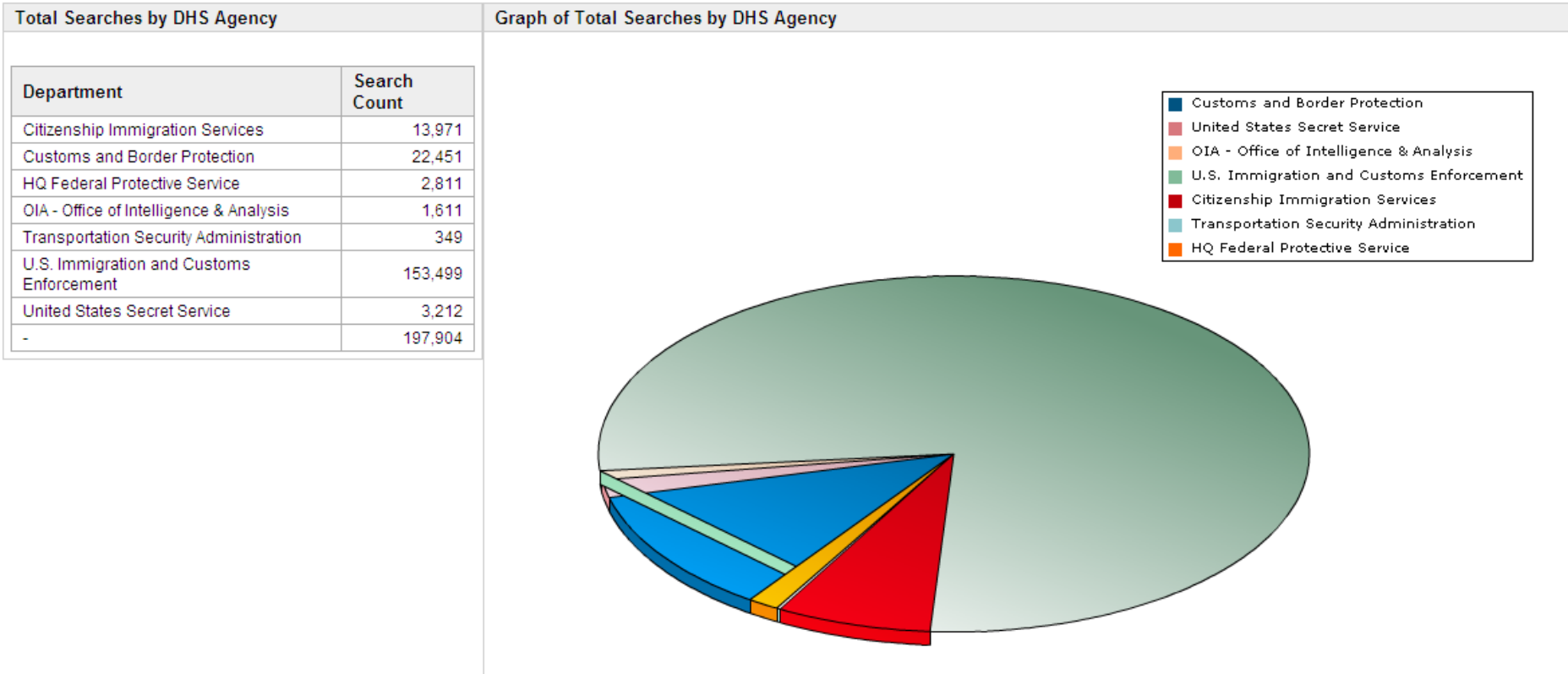



Number of Ingested Records in ICEPIC Core

Information

This data represents records from over 16 data sources including TECS, NSEERS, ENFORCE, ADIS, SEVIS, and LESC, loaded within the most recent three months. The entity count reflects the system identifying multiple records to be the same person.

Total Entities/Records Ingested

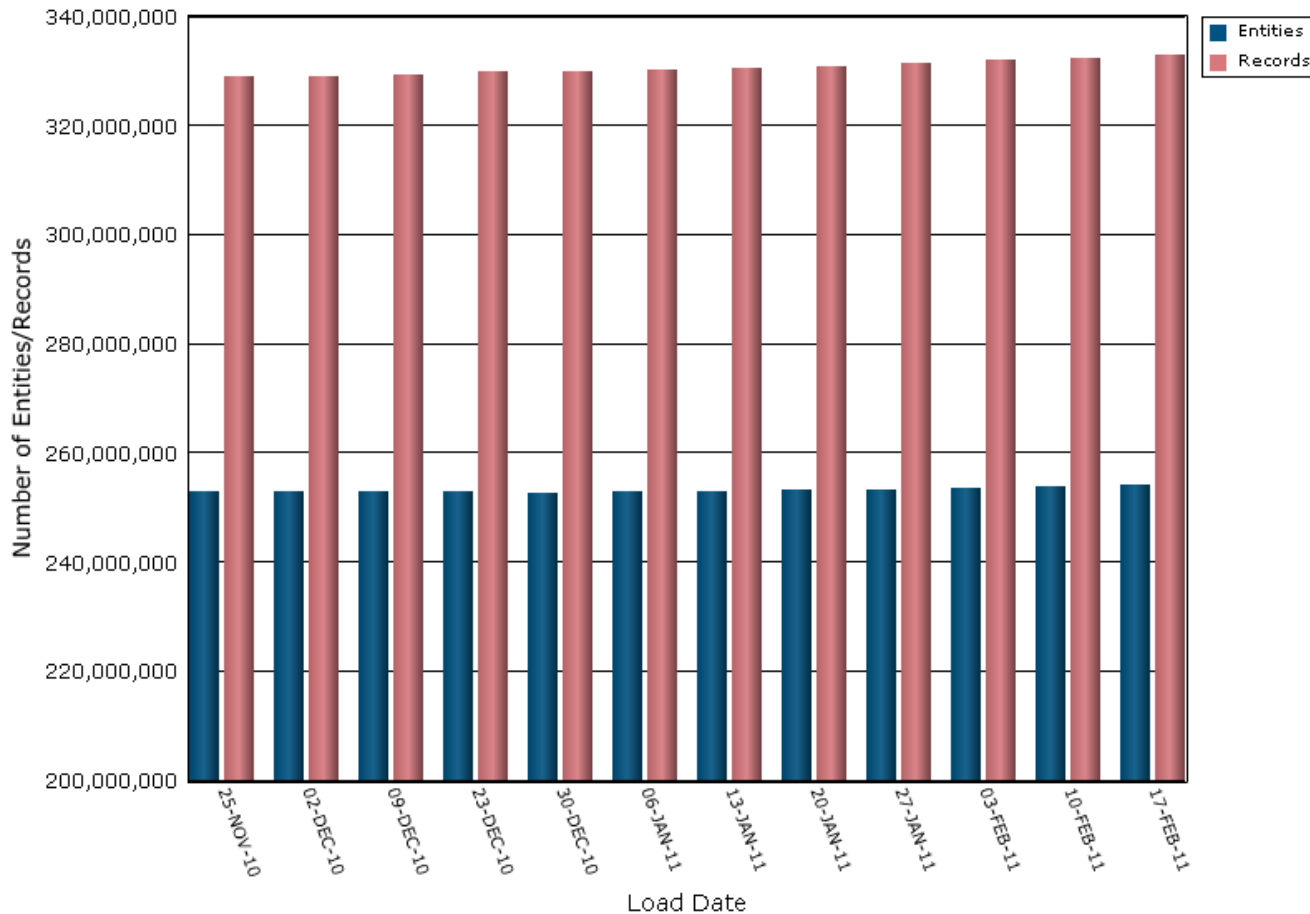

Three Month Total Entities Ingested Report

Load Date	Entities Present
17-FEB-11	254,195,241
10-FEB-11	253,835,927
03-FEB-11	253,620,880
27-JAN-11	253,352,342
20-JAN-11	253,146,072
13-JAN-11	253,074,976
06-JAN-11	253,066,968
30-DEC-10	252,778,417
23-DEC-10	252,847,964
09-DEC-10	252,886,320
02-DEC-10	252,925,987
25-NOV-10	253,054,127

1 - 12

Three Month Total Records Ingested Report

Load Date	Records Present
17-FEB-11	332,986,720
10-FEB-11	332,456,547
03-FEB-11	332,014,594
27-JAN-11	331,435,779
20-JAN-11	330,894,403
13-JAN-11	330,575,618
06-JAN-11	330,338,989
30-DEC-10	330,003,930
23-DEC-10	329,860,761
09-DEC-10	329,450,226
02-DEC-10	329,180,369
25-NOV-10	329,040,475

1 - 12

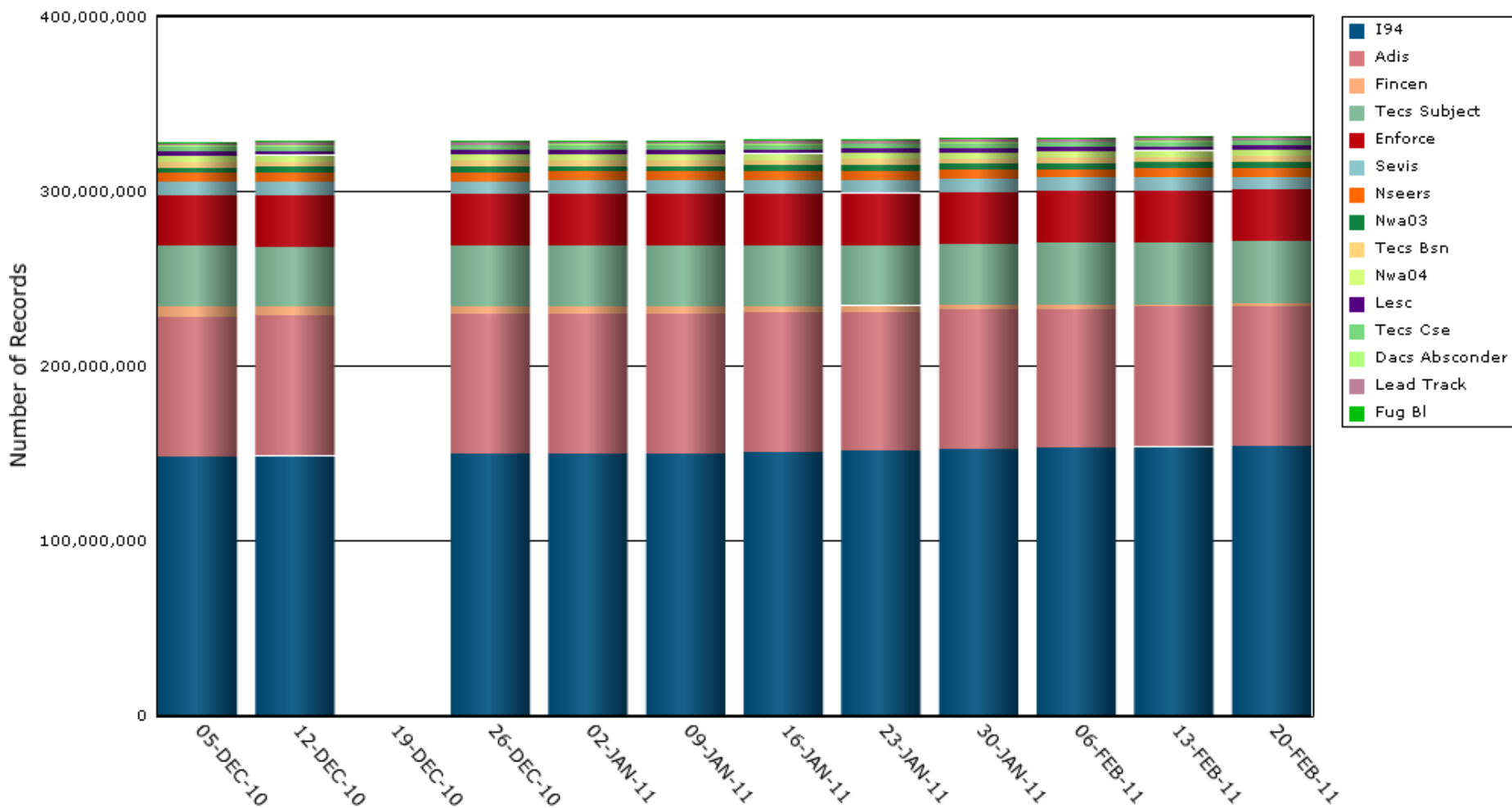



Current Law Enforcement Information Sharing Network

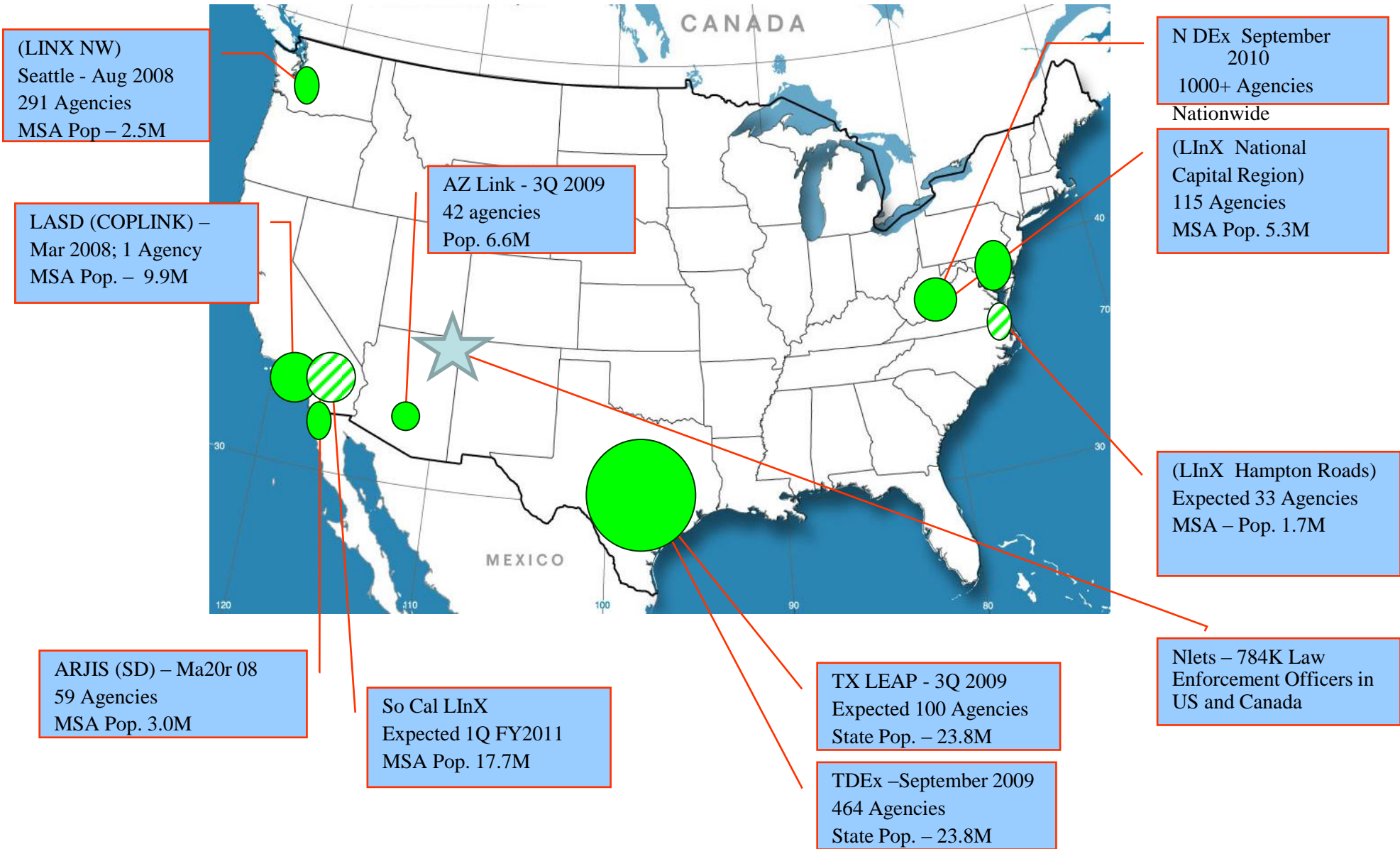



- **Current Status**

- **Existing Connections**

- **ARJIS: 59 participating agencies; 6,406 user accounts**
- **LASD: 1 participating agency, 973 user accounts**
- **LInX NW: 301 participating agencies; 11055 user accounts**
- **AZLink (Tucson, Maricopa, Mesa): 42 participating agencies; 6,330 user accounts**
- **OneDOJ: 8 participating agencies; 936 user accounts**
- **LInX NCR: 115 participating agencies; 8,900 user accounts**
- **T-DEx: 464 participating agencies, 20,924**
- **State Department CCD: 1 participating agency**
- **Total: 991 participating agencies: 55,524 user accounts**

- **Future**

- **HSIN – Fusion Centers/Non-Regional State and Local Systems**
- **Full Deployment of NLETS**
- **Enrichment of data sources**
- **Incorporate DHS components into LEISS such as FPS and Coast Guard**



- LEXS 2.0 implemented in LEISS
 - Structured Search Request
 - Structured Search Response
 - Get Item Request
 - Get Item Response
- LEXS 3.1 Implementation in LEISS
 - Provides the above functionality plus
 - Get Attachments Request
 - Get Attachments Response
 - This enables retrieval and display of attachments such as ENFORCE mug shots
 - This can be expanded to retrieve attachments from other sources
 - LEISS 1.7 also provides the ability to search unstructured text
- Additional fields Provided in LEISS 1.7 using LEXS 3.1
 - ENFORCE Photos
 - TECS Case information



- Enforce

- Robust Biometric and Biographic Data Attributes
- Images, Mug shots, Scars/Marks/Tattoos

- TECS

- Case Status
- Case Agent First Name
- Case Agent Last Name
- Case Agent Phone
- Case Title
- Case Short Description
- Joint Task Force Indicator

- Efficient Architecture

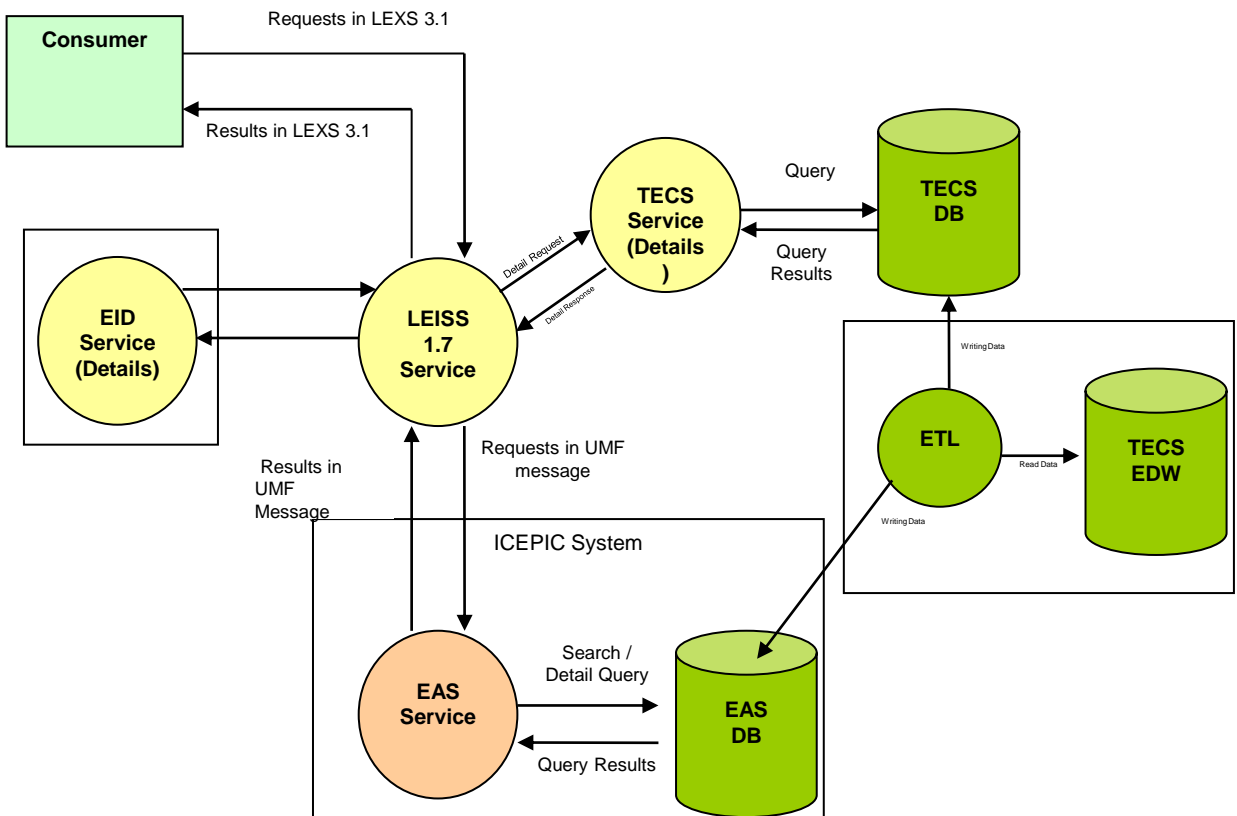



- Deconfliction (D-NDPIX), meeting Officer Safety
 - Submissions in past 12 Months – **1,099**
 - Hits (Operational ‘Clashes’) – **288**
- Large Public Events, Vendor Employee Verification
 - Super Bowl 2011 (33,381 Vendor Applications/337 ‘Hits’)
 - Pro Bowl (2,259 Vendor Applications/11 ‘Hits’)
 - National Party Conventions
- Organized Crime Drug Enforcement Task Force (OCDETF) Sharing

Category	Count
TOTAL CASES	794,666
TOTAL ROIS	4,860,124
TOTAL NARRATIVES	18,946,083
TOTAL PERSON SUBJECTS	5,927,094
TOTAL ORGS	355,053
TOTAL AIRCRAFTS	5,210
TOTAL THINGS	79,087
TOTAL VEHICLES	552,450
TOTAL VESSELS	151,207
Report Total:	31,670,974



About Nlets (CONT.)

- **Nearly 1 billion**
 - Transactions a year
- **900,000**
 - PC, mobile and handheld devices in the U.S. and Canada
- **45,000**
 - User agencies
- **1.2 million**
 - Individual users

- In addition to all State, Local, Tribal and International users, many Federal Agencies gain access to DHS LE data

- The DHS LEISS will control its rollout with NLETS
- Users query the LEISS via a General Purpose Query (**GPQ**)
- This capability addresses the DHS LEISS Mission for **Officer Safety**



USER AGENCIES

Federal

Air Force	Federal Aviation Administration	Navy
Army	FBI / NCIC	Office of Personnel Management
Coast Guard	Federal Motor Carrier Safety Admin.	Postal Inspection Service
Customs & Border Protection	Federal Protective Service	Secret Service
Dept. of Defense (PERSEREC)	Immigration & Customs Enforcement	Social Security Admin., OIG
Dept. of Interior	Interpol	Transportation Security Admin.
Dept. of Justice	National Weather Service / NOAA	U.S. Courts
Dept. of State		Veteran's Affairs
El Paso Intelligence Center		

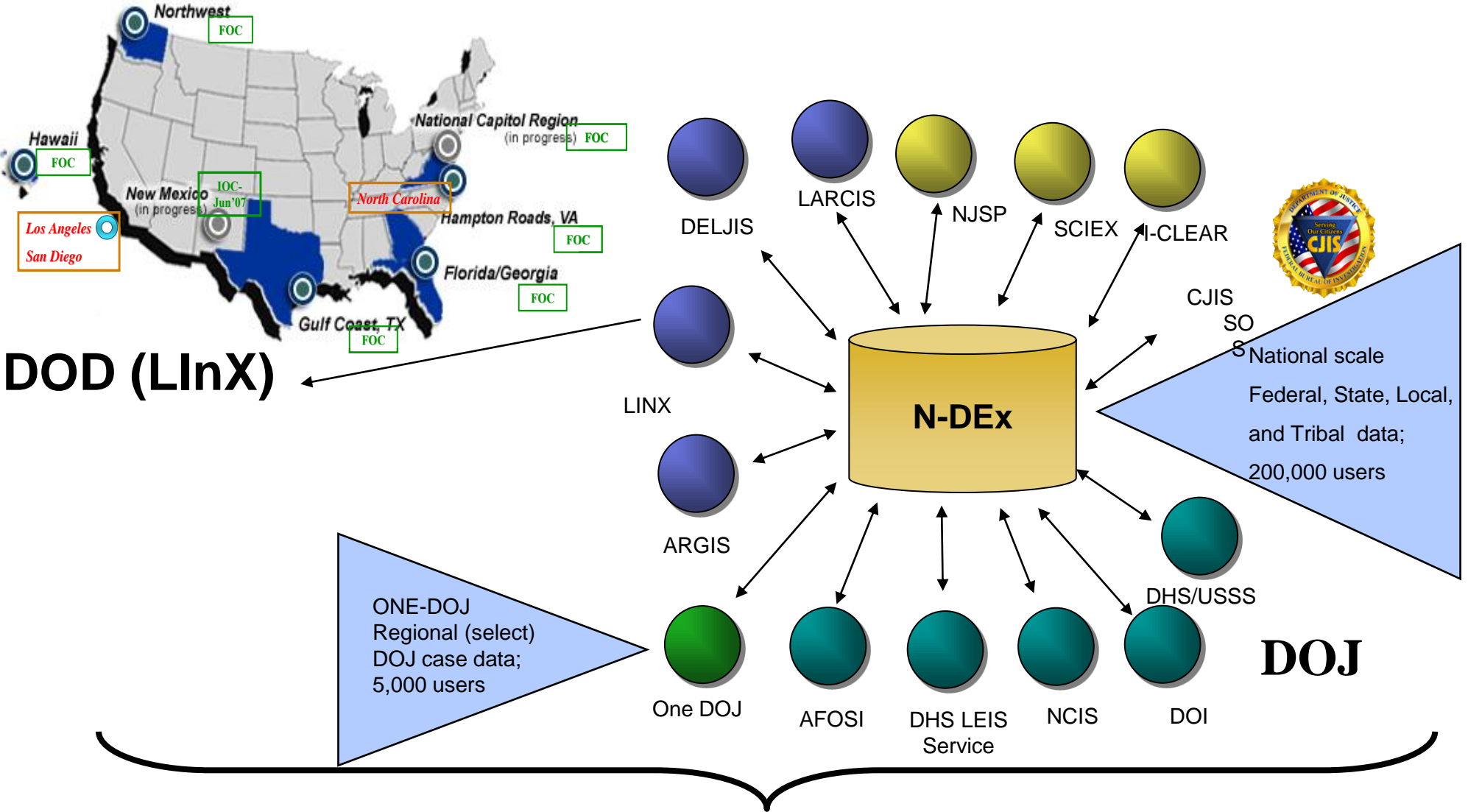

DHS will connect to established communities via N-DEX Connections



Sharing Partners and internal users gain access to Over **103,900,000** records currently in N-DEx and increasing daily

<u>Component</u>	<u>Source</u>	<u>Record Description</u>	<u>Data Volume</u>
ATF	NFORCE	<ul style="list-style-type: none"> •Subject of Interest •Open & Closed cases 	87,099
BOP	ITSLOG	•Federal inmate authorized call logs	11,176,243
	ITSLIST	•Federal inmate authorized call lists	2,469,401
	SENTRY	•Federal inmate biographical & activity records through out incarceration	1,528,997
DEA	NADDIS	<ul style="list-style-type: none"> •Subjects of interest w/phone numbers, locations and associates •Open cases 	3,286,048
FBI	FBI ECF Data	•Open and closed case records, including narratives	193,114
	FBI UNI Data	<ul style="list-style-type: none"> •Subjects of interest with phone numbers, locations and associates •Open and Closed cases 	482,193
U.S. Marshal Service	WIN	•Case Records	52,693
JABS - Joint Automated Booking System	JABS	•Images	3,760,368
	JABS	•Booking data	3,413,335



State

- Illinois (I-CLEAR)
- Indiana – DOC
- Massachusetts (SWISS)
- Nevada – DOC
- New York (NYDEX)
- Oklahoma (SIBRS)
- West Virginia – DOC

Regional

- Chicago (CLEAR)
- District of Columbia MPD
- Gulf Coast Region (LInX)
- Los Angeles Police Department
- Marietta, GA Police Department
- Mifflin County, PA
- National Capitol Region (LInX)
- New Orleans Police Department
- North Little Rock, AR
- Northwest Region (LInX)
- Rio Grande (LInX)
- Santa Clara, CA (SBISS)
- Southeast Region (LInX)
- Southeastern Pennsylvania (LEJIS)
- Southern California (LInX)
- St. Louis (Crimematrix)

N-DEX/OneDOJ Sharing Network June 2011

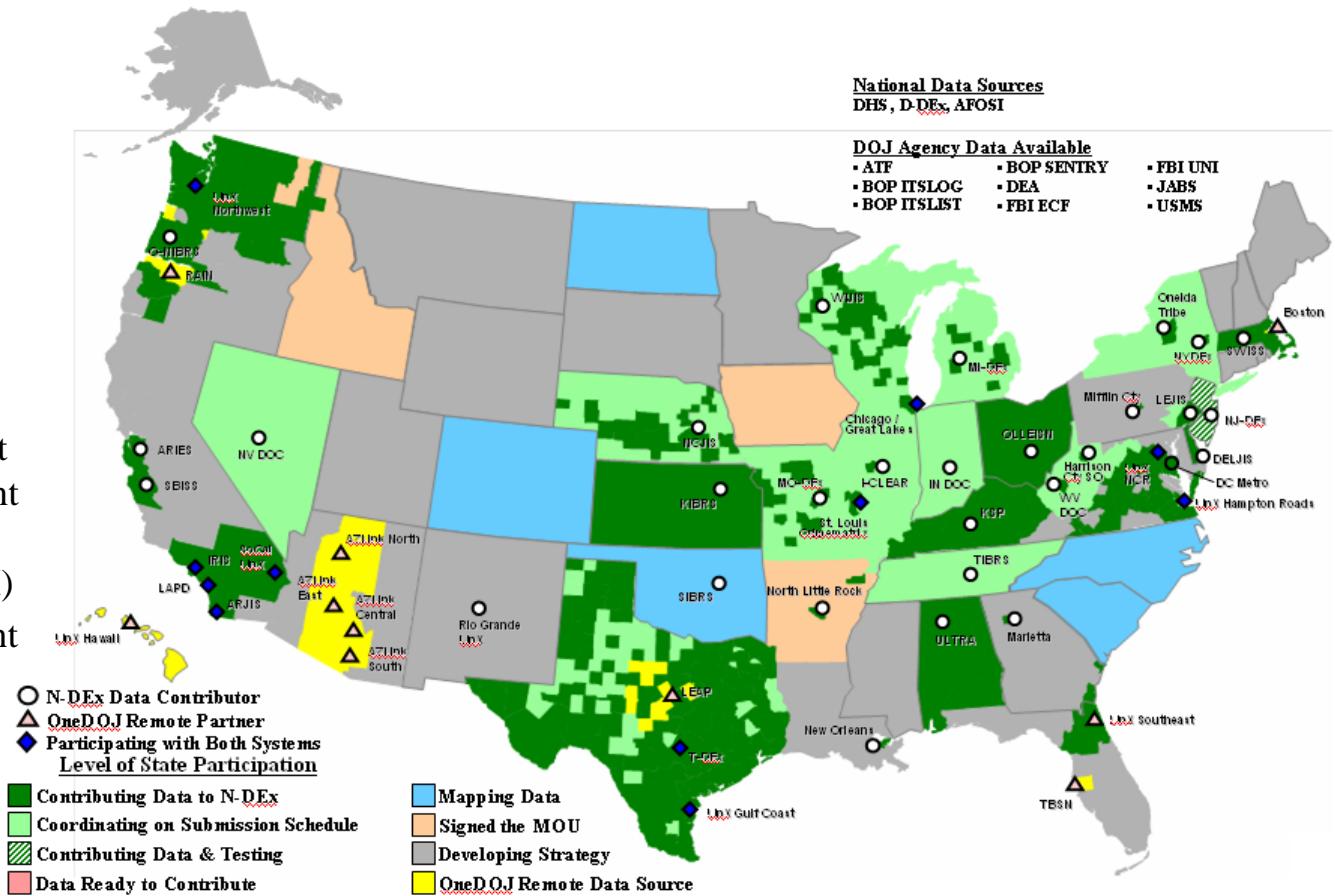



- **Funding**

- No recognition as a Department budgetary line item
- Limited visibility in resource allocation process
- Limited personnel resources

- **Law Enforcement Information Sharing Service (LEIS Service)**

- ICE Law Enforcement Support Center (LESC) is the current 24-hour contact point for law enforcement agencies needing additional information.
- As the LEIS Service grows and is able to ingest other DHS component information for sharing, the LESC will need to have component expertise available to answer questions beyond those concerning immigration centric information.

- **Expansion of DHS Accessible data elements**

- ICE and CBP are the only contributors of LE data to the DHS LEIS Service



- 2010 IACP Conference
- 2010 Major City Chiefs Conference
- 2010 Nlets Federal Members Meeting
- 2011 IJIS Conference
- 2011 National Fusion Center Conference
- 2011 IACP Law Enforcement Information Management Conference
- 2011 APCO Conference
- 2011 National Sheriff's Association Conference
- 2011 IIR Global Justice Information Sharing Initiative
- 2011 Nlets Conference
- Various Partner Conferences and Meetings