

**UNCLASSIFIED**

---

# **Electromagnetic Pulse (EMP) Protection and Restoration Guidelines for Equipment and Facilities**

**With Appendices A - C**

---



December 22<sup>th</sup>, 2016

Version 1.0

Developed by the  
National Coordinating Center for Communications (NCC)  
National Cybersecurity & Communications Integration Center (NCCIC)  
Arlington, Virginia

**UNCLASSIFIED**

## Acknowledgements

The EMP protection guidelines presented in this report were initially developed by Dr. George H. Baker, based on his previous work where he led the Department of Defense program to develop EMP protection standards while at the Defense Nuclear Agency (DNA) and the Defense Threat Reduction Agency (DTRA). He is currently serving as a consultant to the Department of Homeland Security (DHS) and is emeritus professor of applied science at James Madison University (JMU). He presently serves on the Board of Directors of the Foundation for Resilient Societies, the Board of Advisors for the Congressional Task Force on National and Homeland Security, the JMU Research and Public Service Advisory Board, the North American Electric Reliability Corporation GMD Task Force, the EMP Coalition, and as a Senior Scientist for the Congressional EMP Commission.

A second principal author is Dr. William A. Radasky. Dr. Radasky received a B.S. degree with a double major in Electrical Engineering and Engineering Science from the U.S. Air Force Academy in 1968. He also received M.S. and Ph.D. degrees in Electrical Engineering from the University of New Mexico in 1971 and the University of California, Santa Barbara in 1981, respectively with an emphasis on the theory and applications of electromagnetics.

Dr. Radasky started his career as a research engineer at the Air Force Weapons Laboratory in Albuquerque, New Mexico in 1968 working on the theory of the electromagnetic pulse (EMP). In 1984 he founded Metatech Corporation ([www.metatechcorp.com](http://www.metatechcorp.com)) in Goleta, California where he is currently President and Managing Engineer. He has published over 400 technical papers, reports and articles dealing with electromagnetic interference (EMI) and protection.

In 1989, Dr. Radasky began his volunteer work with the International Electrotechnical Commission (IEC) developing reports and standards to protect commercial equipment and systems against the threats of high-altitude electromagnetic pulse (HEMP) and Intentional Electromagnetic Interference (IEMI). He has led the development of 17 publications and three new projects as Chairman of IEC SC 77C since 1991. In addition, he helped to coordinate all of the electromagnetic compatibility (EMC) work of the IEC as Chairman of the Advisory Committee on EMC (ACEC) from 1996 to 2008. He has also organized and presented many workshops for the IEC dealing with EMC in general and IEMI. In 2004 he received the Lord Kelvin Award from the International Electrotechnical Commission for exceptional contributions to international standardization. This award is presented annually to up to three individuals of the 15,000 active participants within the IEC.

Dr. Radasky and his team of EMP experts developed the Electromagnetic Assessment Tool (EMAT) for the Department of Homeland Security. The EMAT and the related Infrastructure Mapping Tool (IMT) were used to develop many of the graphics and assessments in this report.

Dr. James L. Gilbert, who serves as the Chief Scientist at Metatech, has helped to lead Metatech's efforts in the development and use of analytic and numerical techniques to model electromagnetic and plasma effects produced by nuclear and natural radiation. Much of his work over the last 40+ years has dealt with the protection of electronic systems from the EMP effects produced by nuclear explosions. He is the principal developer of our Source Region EMP (SREMP) and EMAT codes and has served as a consultant to DHS in modeling solar and EMP effects for many years.

Many others have worked to develop the assessments and information used in this document, most notably: Mr. Rob Benish of Jacobs Federal Network Systems (who assembled much of the information in Appendix B and helped to format and edit the overall document), Dr. Edward Savage of Metatech, Dr. Don Morris-Jones of CSRA, Mr. Seth Sobel of CSRA (who developed many of the EMAT outputs used herein and who modified our SREMP code for use within IMT), Ms. Shaheen Khurana (the former CSRA project lead), Mr. Bronius Cikotas (a well-known leader in the EMP community for decades and mentor to Dr. Baker, who to the great sadness of all, passed away in 2014), and Kevin Briggs (the DHS Project Officer and Principal Editor for this effort).

## **Table of Contents**

Acknowledgements .....	i
Document Change History .....	v
Introduction.....	1
DHS EMP Protection Levels .....	2
Level 1 EMP Protection Guidelines .....	4
Level 2 EMP Protection Guidelines .....	6
Level 3 EMP Protection Guidelines .....	11
Level 3 Mitigation Effects .....	13
Level 4 EMP Protection Guidelines .....	15
Acronyms.....	35
Bibliography.....	37
References.....	40
APPENDIX A – EMP Protection Test and Acceptance Criteria.....	A-1
APPENDIX B – EMP Protection Vendors and Services.....	B-1
EMP Protection Levels.....	B-1
EMP Protection Level 1 .....	B-2
EMP Protection Level 2 .....	B-4
EMP Protection Levels 3 & 4 .....	B-7
New Approaches to EMP Protection.....	B-17
APPENDIX C – Priority Service and Restoration Programs.....	C-1
Priority Telecommunications Services .....	C-1
Government Emergency Telecommunications Service (GETS).....	C-2
Wireless Priority Service (WPS).....	C-2
Telecommunications Service Priority (TSP).....	C-2
SHARES Program.....	C-4



## Tables and Figures

Table 1. Four DHS EMP Protection Levels for equipment and facilities ..... 2

Figure 1. Organization of the current publications of IEC SC 77C ..... 11

Figure 2. Protective effects on cordless telephones achieved with 30 dB minimum recommended shielding..... 13

Figure 3. Protective effects on a 100’ Ethernet cable achieved with 30 dB minimum recommended shielding..... 14

Figure 4. Protective effects on a Plain Old Telephone Service (POTS) Line achieved with 30 dB minimum recommended shielding..... 14

Figure 5. Low-risk EMP barrier protection for facilities (per MIL-STD-188-125-1) ..... 17

Figure 6. Typical cable POE protection design ..... 19

Figure 7. Integrated electric power feeder POE protection..... 20

Figure 8. Power line POE protection using a motor-generator set..... 21

Figure 9a. Entryway using two doors separated by a WBC ..... 21

Figure 9b. Vestibule entryway with door interlocks ..... 22

Figure 10a. Typical waveguide-below-cutoff (WBC) piping POE protective design for E1 HEMP ..... 23

Figure 10b. Typical waveguide-below-cutoff ventilation POE protective design for E1 HEMP..... 23

Figure 11. Shield barrier earth electrode system..... 25

Figure 12. Example receiver protector unit diagram ..... 29

Figure 13a. Special protective volume for piping POE for E1 HEMP ..... 30

Figure 13b. Special protective volume for electrical equipment ..... 30

Figure 14. Global barrier vs. box-level protection..... 32

Figure 15. Box-level hardening techniques ..... 32

Table 2. HEMP Specifications for cable runs between two protected rooms ..... 33

Table A1. Injected pulse characteristics ..... A-1

Table A2. Residual internal stress limits for classes of electrical POEs ..... A-2

Table A3. Injected pulse characteristics & residual internal stress limits for antenna POEs ..... A-3

Figure A-1. HEMP Shielding Effectiveness Requirement ..... A-4

## Document Change History

The table below identifies the major changes in each version of these *EMP Protection Guidelines*.

<b>Date</b>	<b>Version #</b>	<b>Change Description</b>
12/22/2016	1.0	Initial release of revised <i>DHS EMP Protection Guidelines</i> to the Federal Continuity Community Managers Group, FBI InfraGard EMP SIG Community, Appendix B companies, the reestablished Congressional Commission to Assess the Threat to the United States from Electromagnetic Pulse Attack, and others.

## Introduction

This document provides recommendations for protecting and restoring critical electronic equipment, facilities and communications/data centers from:

- (1) High Altitude EMP (HEMP)
- (2) Surface-burst Source Region EMP (SREMP) fields propagating outside of the radiation region
- (3) Currents induced on undersea cables and long lines by solar storm generated geomagnetic disturbances (GMDs)
- (4) Intentional Electromagnetic Interference (IEMI) from nearby sources such as Electromagnetic (EM) weapons (also known as Radio Frequency (RF) weapons).

Collectively, these will be called by a general term in this document: “EMP”. However, it should be recognized that nearly all of the protection recommended in this document is for the frequency range above 10 kHz, which is the frequency range for E1 HEMP, SREMP and IEMI. A presentation describing the background, characteristics and effects of EMP is included in the Appendices to this document.

There are four DHS EMP Protection Levels defined herein, as outlined in Table 1. These levels were initially developed for use by the federal continuity community, such as for the *Continuity Communications Managers Group*, but are also applicable to any organization that desires to protect its equipment, facilities, and services against EMP threats.

In addition to making recommendations on how to physically protect electronic equipment from EMP, this guide provides guidance on how to help ensure communications and information systems (and their supported missions) can continue to function (or be rapidly restored) after one or more EMP events. Hence, Appendix C contains information on priority service programs (like GETS, WPS, and TSP) as well as on the SHARES alternate communications service that can be used to support critical missions and to facilitate and coordinate restoration activities.

## DHS EMP Protection Levels

Level 1 begins with no-cost/low-cost methods to protect equipment and facilities. Level 2 guidelines are based on using EMP-capable filters and surge arresters on power cords and data cables, as well as fiber optics and ferrites, where possible, to protect critical equipment. These would mitigate the majority of EMP vulnerabilities to equipment when EMP facility shielding is not feasible (this is also expected to be the most cost-effective approach for hardening limited equipment in facilities). Levels 1 and 2 are for organizations where hours of mission interruptions can be tolerated and for which “cost to harden” is a critical factor.

**Table 1. Four DHS EMP Protection Levels for equipment and facilities**

<b><u>Level 1: Low \$s</u></b>	<b><u>Level 2: Hours</u></b>	<b><u>Level 3: Minutes</u></b>	<b><u>Level 4: Seconds</u></b>
Use procedures & “low cost” best practices to mitigate EMP effects. Unplug power & data lines into spare/backup equipment. Turn off equipment that cannot be unplugged & that is not immediately needed for mission support. Store one week of food, water, & critical supplies for personnel. Wrap spare electronics with aluminum foil or put in Faraday containers. Have backup power that is not connected to the grid (generators, solar panels, etc.) with 1 week of on-site fuel (like propane/diesel). Use GETS, WPS, & TSP services; join SHARES if applicable (see Appendix C for more information).	In addition to Level 1, use EMP rated surge protection devices (SPDs) on power cords, antenna & data cables & have EMP protected back-up power. Use SPDs (1 nanosecond or better response time) to protect critical equipment. Use true on-line/double-conversion uninterruptible power supplies (UPS). Use fiber optic cables (with no metal); otherwise use shielded cables and ferrites/SPDs. Shielded racks/rooms &/or facilities may be more cost-effective than hardening numerous cables. Use EMP protected HF radio voice/email if need long-haul nets. Suppress EMP fires.	In addition to Level 2, use civil EMP protection standards (like IEC SC 77C). Use EMP shielded racks/rooms and/or facilities to protect critical computers, data centers, phone switches, industrial & substation controls & other electronics. Shielding should be 30-80 dB of protection thru 10 GHz. Use SPDs to protect equipment outside of shielded areas. Can use single-door EMP-safe entryways. Use ITU & IEC EMP standards for design guidance and testing. Have 30 days of back-up power with on-site fuel (or via assured service agreement with EMP resilient refuelers). Use EMP protected HF radio & satellite voice/data nets if need long-range links to support missions.	Use Military EMP Standards (MIL-STD-188-125-1 & MIL-HDBK-423), and 80+ dB hardening thru 10 GHz. Use EMP/RFW shielding in rooms, racks, and/or buildings to protect critical equipment. Use EMP SPDs to protect equipment outside of shielded areas. Use EMP protected double-door entryways. Have 30+ days of supplies & EMP protected back-up power (to include on-site fuel) for critical systems. Don’t rely on commercial Internet, telephone, satellite, or radio nets that are not EMP protected for communications. Use EMP protected fiber, satellite, & radio links & Appendix B services

Level 3 guidelines are appropriate for organizations which can only tolerate a few minutes of mission outages. Level 4 guidelines are for organizations/missions that cannot tolerate more than a few seconds of outage and where lives and essential services/functions are at stake. For EMP Protection Levels 3 and 4, electromagnetically shielded racks and rooms are used to prevent electromagnetic fields and currents from reaching mission critical equipment.

These two highest levels also use testing to verify that EMP shields are effective and that the EMP barrier's integrity is maintained over the life cycle of the system. A properly designed barrier with penetration protection for all power, data and antenna cables will make equipment behind it safe from wide variations in threatening external electromagnetic fields (including HEMP (see the bibliography for more details), SREMP, IEMI and Geomagnetic Storm threats). Protection Level 3 has similar design features as Protection Level 4; however, Level 3 allows some tailoring of the requirements and also allows the use of commercial standards for designing protection and performing testing in a more cost-effective manner.

## Level 1 EMP Protection Guidelines

### **EMP Protection Level 1 Summary (Low cost, best practices):**

Use procedures and “low cost” best practices to mitigate EMP effects. Unplug power and data lines into spare/backup equipment. Turn off equipment that cannot be unplugged and that is not immediately needed for mission support. Store one week of food, water, and critical supplies for personnel. Wrap spare electronics with aluminum foil or put in Faraday containers. Have backup power that is not connected to the grid (generators, solar panels, etc.) with 1 week of on-site fuel (like propane/diesel). Use the Government Emergency Telecommunications Service (GETS), Wireless Priority Service (WPS), and Telecommunications Service Priority (TSP) programs to improve your chances of phone call completions and rapid restorations during EMP crises; and join the SHARed RESources (SHARES) program if applicable (see Appendix C for more information on all of these programs).

### **1. Turn off and unplug equipment.**

The easiest and quickest way to reduce equipment vulnerabilities to EMP is to turn off non-essential equipment and then unplug this equipment from all metallic lines, such as power cords, telephone lines, Ethernet cables, and antennas/coaxial cables. Battery packs should be removed from small electronics as these batteries can work in conjunction with EMP to provide damaging energy into equipment circuits. Where possible, the cords themselves should also be disconnected from the equipment, not just unplugged at the wall or other distant connection point. The rationale here is that these power cords and data cables will still act as antennas for picking up EMP signals even if they are disconnected from a wall outlet or router or external radio or TV antenna. As an extra precaution, you should also disconnect your non-essential computer(s) from any wired external keyboard or mouse. You should unplug all cords and cables at the point where they actually connect to the equipment, such as at the back of a computer or desktop phone or equipment rack. If you cannot unplug the equipment from a long metallic cable, then coil the cable near the equipment, if possible, so as to minimize its effective length and hence reduce its ability to pick up EMP energy. For wireless devices such as cell phones and other battery operated devices (like portable radios and walkie-talkies), you should turn them off and unplug them from any charging station or adapter. If items need to be charged, be sure to use power cord surge protectors that have a 1 nanosecond or better response time (which can be found at normal retail stores).

**2. Use power surge protectors that provide fire protection.**

Many surge protectors use metal oxide varistors (MOVs) that can be a fire risk when they fail. Some manufacturers, like Monster Cable Products, Inc., provide fire-proof MOVs.

**3. Use heavy-duty aluminum foil or inexpensive faraday bags/cases.**

For small electronics, you can put these in a plastic or paper bag or other insulating material and then wrap the item with an outer layer of heavy-duty aluminum foil. If power or data cables are permanently connected to the equipment, you should also place these inside the bag before wrapping the item with aluminum foil. You should ensure the aluminum foil completely covers the item and that all seams overlap. If possible, protect the equipment with two or more complete layers of aluminum foil. If you decide to use a faraday bag, be sure that it is not just a standard Mylar food bag which provides little protection. Metal trash cans do not usually provide reliable EMP protection for items placed inside of them, unless they have been modified to block radio waves from entering through the gaps in the lid, handles, and sometimes at the base. Microwave ovens can serve as expedient faraday cages for small electronics, but should be tested with a cell phone and/or AM/FM radio to see if there is reception inside of the oven (obviously, these “ovens” should never be turned “on” with equipment inside). In general, small handheld electronics are relatively resilient to EMP effects, unless they have long antennas or power cords attached, and so the need for faraday cages is of secondary importance.

**4. Ensure your backup generator is not connected to commercial power (unless it has very good EMP surge protection on the connecting line).**

While many companies will recommend connecting your backup diesel or other generator to commercial power in order to provide an automated transfer to backup power when commercial power is lost, you should avoid this if possible. The relatively long commercial power lines leading to your home or organization provide an excellent path for EMP energy and may destroy your backup generator’s electronics if they are wired into an automated transfer switch.

## Level 2 EMP Protection Guidelines

### **EMP Protection Level 2 Summary (where hours of mission outage is acceptable):**

In addition to Level 1, use EMP rated surge protection devices (SPDs) on power cords, antenna & data cables and have EMP protected back-up power. Use SPDs (1 nanosecond or better response time) to protect critical equipment. Use true on-line/double-conversion uninterruptible power supplies (UPS). Use fiber optic cables (with no metal); otherwise use shielded cables and ferrites/SPDs. Shielded racks/rooms and/or facilities may be more cost-effective than hardening numerous cables. Use EMP protected HF radio voice/email if need long-haul nets. Suppress EMP fires. If room and/or equipment rack EM shielding is desired, then refer to Level 3 or 4 EMP Protection Guidelines.

### **1. Use of EMP rated surge arresters on power cords and phone/data cables**

Many commercially available power strips have surge protection built in. These should be used to protect all essential equipment and must have a response time rating of 1 nanosecond or faster and a minimum rating of 3,000 joules and an additional let through voltage of 60 V or less to be effective for EMP types of transients. Phone line and data cable surge arresters should also be used that have a response time rating of 1 nanosecond or faster and an additional let through voltage of 60 V or less to be effective.

### **2. EMP fire suppression**

EMP fire suppression spark arresters or other equipment designed for this purpose should be considered for essential buildings to help prevent EMP induced fires in facilities. Many commonly available power strips use fire-protected MOVs and if spaced at distances of every 20 feet or so, can help mitigate MOV and spark-induced fires from EMP.

### **3. Use of ferrites**

- Cable ferrites are often used to attenuate unwanted high-frequency cable signals. Ferrites use materials that interact with the magnetic field of the cable signal. Type 61 material ferrites are recommended in that they can attenuate pulses with faster rise times than those made with older ferrite materials, such as type 43 ferrites.
- These are simple and inexpensive – they simply snap around the cable (preferably near the vulnerable equipment end).
- They effectively introduce a complex impedance onto the cable – there is signal attenuation because:
  - Impedance mismatch relative to the normal cable impedance means some signal is reflected back down the cable,



- And the imaginary part of the impedance means that energy is absorbed.
- The impedance is frequency dependent, with peak typically hundreds of ohms.
- A useful property is that this impedance affects only common mode cable signals (which HEMP is) and not differential mode (which are the normal cable signals).
- The protection is additive with each extra bead snapped on; there is approximately 1 to 2 dB protection per ferrite.

#### **4. HF and other radio equipment protection**

HF and other radios need three types of protective devices – (1) those for the HF or other radio antennas, (2) those for power connections and (3) those for low voltage DC connections such as antenna rotators. Protective devices must be well grounded using low-inductance grounding cables as short as possible.

For HF antennas, the protector voltage rating needs to be greater the transmitter peak voltage, with a factor of two margin preferable. As a function of power P in watts for 50 Ω systems, this gives a protector voltage rating V of:  $V = 20\sqrt{P}$ , which is 200 V for a 100 W system, 400 V for a 400 W system and 630 V for a 1 kW system.

#### **5. Coaxial Cable RF (Antenna) Surge Protectors**

Nothing can protect equipment from a direct lightning strike. Antenna surge protectors are designed to reduce antenna-induced voltages resulting from nearby lightning voltage discharges. A HEMP's rise time is ~1 ns. An HF antenna and feedline will slow this down to longer than 10 ns. Most antenna surge protectors contain gas discharge tube (GDT) devices with typical element turn-on time faster than 5 ns providing suitable protection from EMP.

Each protector is installed in series with the antenna feedline. The GDT inside the protector is connected from the center conductor to the shield, so the GDT element is in parallel with the feedline. A GDT is a normally-open voltage-sensing device. When the voltage is sufficiently high, the gas inside the GDT ionizes and conducts which reduces the voltage on the center pin with respect to the outer shield. If the surge is great enough, an arc inside the GDT develops further reducing the voltage. The GDT returns to an open state after the power being shunted through it decreases.

GDTs wear out with each surge event and usually fail by becoming either open or shorted. It is easy to detect when a GDT shorts (because the transmitter will shut down from high VSWR), but not when it opens. What happens when a GDT opens is the gas inside won't ionize anymore, but there is no easy way to predict when that will occur: RF signals will pass through the GDT just as usual but the GDT won't conduct so it no longer provides any protection. One way to detect a used-up GDT is by checking the initial SWR and periodically repeating the SWR measurements: If the SWR changes, it may be time to

replace the GDT. For more detailed information, see PolyPhaser's white paper <http://www.polyphaser.com/SiteMedia/SiteResources/WhitePapersandTechnicalNotes/1474-003.pdf?ext=.pdf> which describes taking a baseline VSWR reading at initial surge arrester installation. Over time, take repeat VSWR readings. As the GDT wears out, even while in an open state, the GDT's capacitance may change which affects the VSWR. So, over time (which may be a few years), if you see a consistent change in VSWR readings (that isn't related to a bad cable, bad connectors, or a bad antenna), then the most likely cause is the degraded state of the GDT surge arrester.

It's a good practice to replace GDT protectors at least every five years because it's difficult to determine if a GDT is functioning. The strength of each induced EMP from a lightning strike varies greatly (depending how far away each lightning strike is), so you can't predict the strength of any surge reaching the GDT. The life of an installed GDT surge arrester could be 200 nearby strikes over many years or just one extremely close strike. Conducting regular VSWR tests and having a five-year replacement plan can help ensure continued protection.

Protectors are commercially available from Polyphaser, Huber+Suhner, Fischer Custom Communications, Polyphaser, Amphenol® EMI/EMP Protection Connectors, and ETS-Lindgren. Bourns manufactures GDT elements for other companies to repackage into protective devices. The following URLs provide more information about using protective devices.

Gas Discharge Tubes (GDT)

[http://www.bourns.com/resources/training/circuit-protection/gas-discharge-tubes-\(gdt\)/gas-discharge-tubes-\(gdt\)](http://www.bourns.com/resources/training/circuit-protection/gas-discharge-tubes-(gdt)/gas-discharge-tubes-(gdt))

Telecommunications Application Schematics

<http://www.bourns.com/applications/telecommunications>

Network Communications PortNote® Solutions

<http://www.bourns.com/applications/network-communications>

## **6. Uninterruptible power supply (UPS) considerations**

Protection for 120 VAC from either inverters from photovoltaic arrays, diesel generators or commercial power would best be done with a UPS, [note that the UPS itself will need protection from A/C power feed transients, as the UPS may be vulnerable to low frequency EMP (E3) or GMD caused power service transformer harmonics] as modern switched-mode power supplies contain microelectronics potentially sensitive to fluctuations. UPSs made by APC, CyberPower and Tripp are available in suitable power ratings throughout the range from 200 W to 1200 W. It is not clear without testing whether protection is needed for the antenna rotator circuit, as the excitation will be common mode while the operation is

differential mode, but if testing proves it necessary, the installation of MOVs appropriate for the operating level of the specific rotator would suffice.

When selecting a UPS for protecting equipment from EMP, it is recommended that a true on-line, double-conversion type of UPS be used. It should be noted that since there may not be a shielded volume present, less expensive UPS units provide insufficient protection in that they allow voltage spikes to reach equipment before the battery is switched into the circuit, which can take as long as 25 milliseconds. The more expensive on-line, double-conversion UPS ensures that the battery is always connected so that no power transfer switches are needed and no delay occurs.

## **7. Cable layouts, entry, and the use of shielded cables**

Cable layout techniques to reduce the coupling of EMP signals at the equipment include:

- Run location: Run the cable along metal structures, such as metal walls or I-beams.
- Cable bundles: Put multiple cables into tight bundles – on average all the cables are helping to short out the E field seen by any individual cable.
- Ground wires: Better yet, put a ground wire in the cable bundle, and short it out at many points along the cable bundle run.
- Metal cable tray: If cable trays are used to hold the cables, be sure the tray is metal instead of plastic or fiberglass; and have it grounded often along the run.
- Metal cable conduit: It is even better to have the cables in enclosed metal conduits, which are well grounded at least on the ends, and at other points if possible. The best end connection is a circumferential ground bond onto a metal building wall.

Cable entry best practices include:

- Use underground cable runs, at least for the part nearest the building (underground cables have reduced HEMP, SREMP (radiated fields) and EM weapon field coupling, and higher attenuation of signals that have already induced currents).
- Short out the external conductor at the entry point to the building – it is especially good to use shielded cables, with the shield circumferentially bonded to a metal external wall.
- If the building has an ANSI/TIA/EIA-607 Telecommunications Bonding Backbone (TBB) installed, entry cable shielding should be bonded to the TBB.
- Metal pipes also count as conductors – they should be shorted at the metal wall.
- TPD (terminal protection devices) may be needed on power and signal wires.
- Antennas need special attention, and possibly special surge protectors (see above).

Considerations with shielded cables include:

- Using shielded cables is very common in EMP protection, and it is easy to get shielded network cables.
- The protection provided depends on the quality of the shield, but also on the handling of the cable ends.
- Common shielded network cabling has simple foil shields. Better, and more expensive, cables use high-coverage braided shields.
- The cable plugs must have metal sheaves, firmly grounded to the cable shields.
- The matching jack must also be configured to accept the shielded plug – typically with metal tabs. These tabs are not equivalent to circumferential shields, but provide some protection.
- Typical network equipment does not always have shield-ready jacks, so in these cases shielded network cables will not be of value.

### Level 3 EMP Protection Guidelines

**EMP Protection Level 3 Summary (where only minutes of mission outage is acceptable):**

In addition to Level 2, use civil EMP protection standards (like International Electrotechnical Commission (IEC) SC 77C). Use EMP shielded racks/rooms and/or facilities to protect critical computers, data centers, phone switches, industrial and substation controls and other electronics. Shielding should be 30-80 dB of protection thru 10 GHz. Use EMP rated surge protection devices (SPDs) to protect equipment outside of shielded areas. Facilities can use single-door EMP-safe entryways. Use International Telecommunication Union (ITU) and IEC EMP standards for design guidance and testing. Have 30 days of back-up power with on-site fuel (or via assured service agreement with EMP resilient refuelers). Use EMP protected HF radio and satellite voice/data nets if organizations need long-range links to support missions. Expedient shield testing can be accomplished using interior scans for FM and AM radio reception and for cell phone signal detection or with the use of IEEE 299. Organizations can also use publically available IEC SC 77C standards versus military standards for further protection guidance.

The following IEC publications apply to Level 3 Protection and are shown in summary below and in detail in the Bibliography at the end of this report:

<b>61000-1- (General)</b>	-3 HEMP Effects On Systems	-5 HPEM Effects On Systems		
<b>61000-2- (EM Environment)</b>	-9 HEMP Radiated Environment	-10 HEMP Conducted Environment	-11 Classification Of HEMP Environments	-13 HPEM Environments
<b>61000-4- (Testing and Measuring Techniques)</b>	-23 Test Methods Radiated	-24 Test Methods Conducted	-25 HEMP Immunity Tests	-32 HEMP Simulator Compendium
	-35 HPEM Simulator Compendium		-36 IEMI Immunity Test Methods	
<b>61000-5- (Installation and Mitigation Guidelines)</b>	-3 HEMP Protection Concepts	-4 Specifications For Radiated Protection	-5 Specifications For Conducted Protection	-6 Mitigation Of External EM Influences
	-7 EM Code	-8 HEMP Protection Methods For The Distributed Civil Infrastructure	-9 System-level Susceptibility Assessments For HEMP And HPEM	-10 Application Guide
<b>61000-6- (Generic Standards)</b>	-6 Generic Standard For HEMP Immunity			

Figure 1. Organization of the current publications of IEC SC 77C

[Black text indicates publications dealing with HEMP, while blue/grey text indicates HPEM/IEMI publications.]

The Level 3 Facility EM barrier should be designed with the same features and provisions as Level 4 (with the exception of Provision 1 noted below) and the requirement for only one entryway door instead of a double-door entry as in Level 4. With only a single door, an alarm or automatic closing feature should be installed to prevent the door from inadvertently remaining open for an extended period thus reducing the hardness of the facility. In addition for Level 3 the evaluation of the shielding effectiveness as identified in Provision 5 for Level 4 is not required. Commercial radio signal techniques may be used to evaluate the shielding effectiveness or one may use IEEE 299 [see Reference 11]. This shielding effectiveness testing is only required for the acceptance of the shielded enclosure, as verification testing is not required (as it is in Level 4). Also non-linear filter PCI testing may be performed in the laboratory and is not required to be performed on site (as it is in Level 4).

### **1. Six-sided electromagnetic shield barrier**

The shield barrier can be constructed using 3-6 mm thick steel sheeting (or by using other shielding materials, such as aluminum or nickel composites) which provides the required level of shielding. *Shielding can be accomplished using a combination of bolt-together designs and/or welded designs.* If a large number of facilities need to be EMP protected, bolt-together designs that are carefully tested in the factory to meet the required protection levels are more economical. Copper, aluminum, conductive plastics or other materials may be used if they can provide the required shielding effectiveness and are fully compatible with the POE protective treatments and grounding requirements. Steel is preferred because of its superior shielding effectiveness at low frequencies and its mechanical strength. Using metal screen or wire mesh for the barrier presents problems related to inadequate inherent shielding properties and problems posed in circumferentially bonding cable conduit, vent, and piping penetrations to mesh/screen materials.

### **2. Uninterruptible power supply (UPS) considerations**

When selecting a UPS for protecting equipment from EMP, it is recommended that a true on-line, double-conversion type of UPS be used. As this UPS will be installed inside the shielded volume, there is no concern over high frequency transients. However, the UPS selected should have been tested against high harmonic currents and voltages (especially the 2<sup>nd</sup> harmonic), which is generated during E3 HEMP and/or GMD events.

### Level 3 Mitigation Effects

Level 3 EMP Protection recommends a minimum of 30 dB of attenuation from a protective shield thru 10 GHz. How much additional shielding may be required beyond 30 dB is best determined through an EM Threat Site Assessment Survey. Additional shielding may be required based on the facility’s specific operational requirements including factors such as building construction, physical site layout, the types and amount equipment to be protected, and how distributed or contained power systems and wired infrastructure extended beyond the building or campus.

Figures 2 through 4 below illustrate that just applying the minimum recommended level of 30 dB of attenuation can mitigate the EMP threat to typical cables and devices found in most every building. The upper models in each example show the unshielded directionally oriented effects from a 1000 kT burst at 400 km above the center of the continental United States. The bottom model in each example shows the survivable effect provided by 30 dB of shielded attenuation.

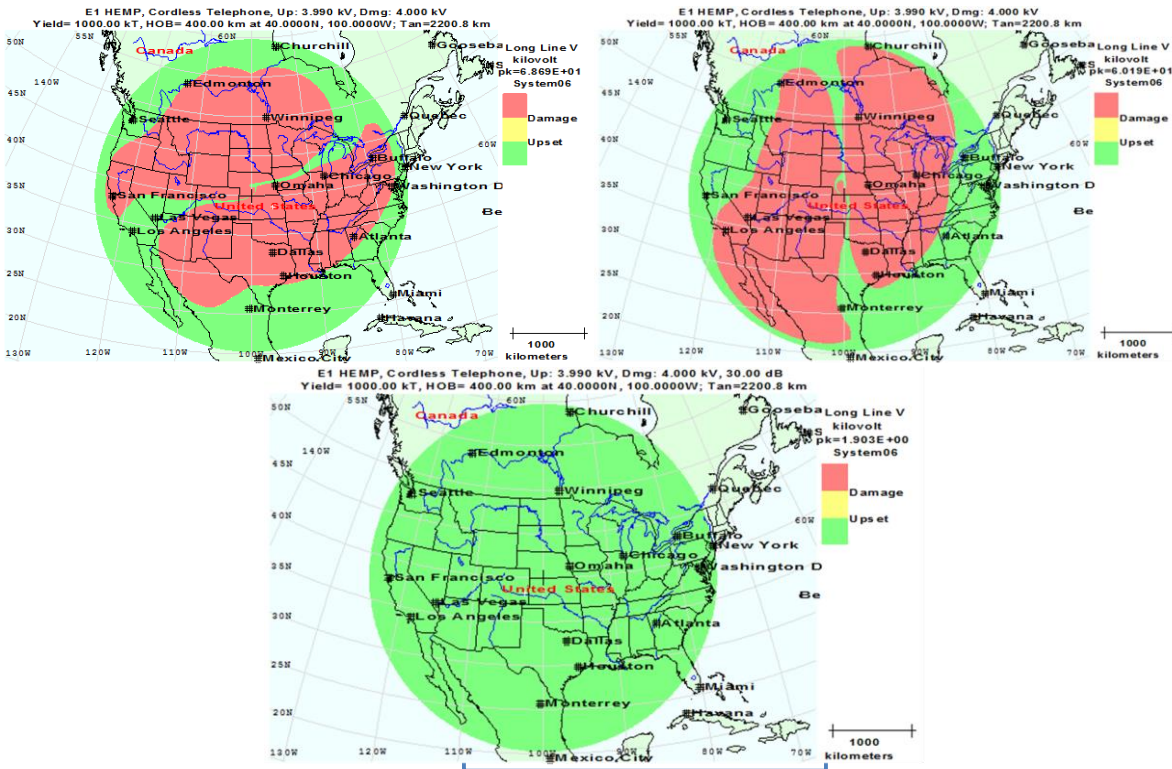

Figure 2. Protective effects on cordless telephones achieved with 30 dB minimum recommended shielding.



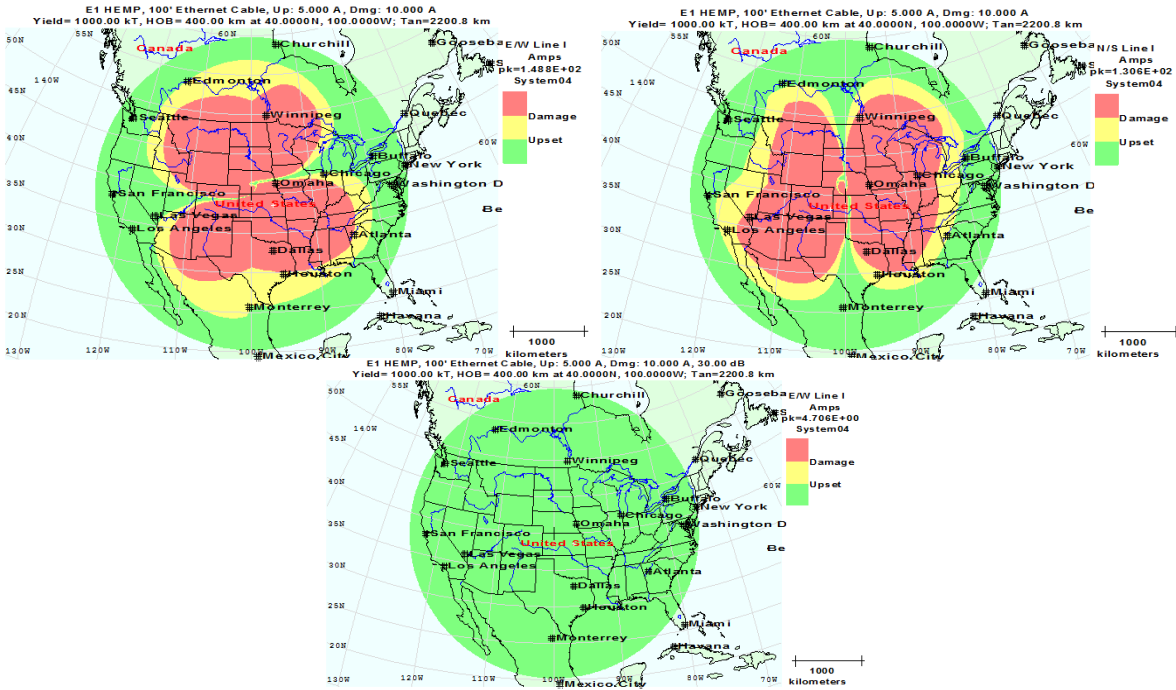

Figure 3. Protective effects on a 100' Ethernet cable achieved with 30 dB minimum recommended shielding.

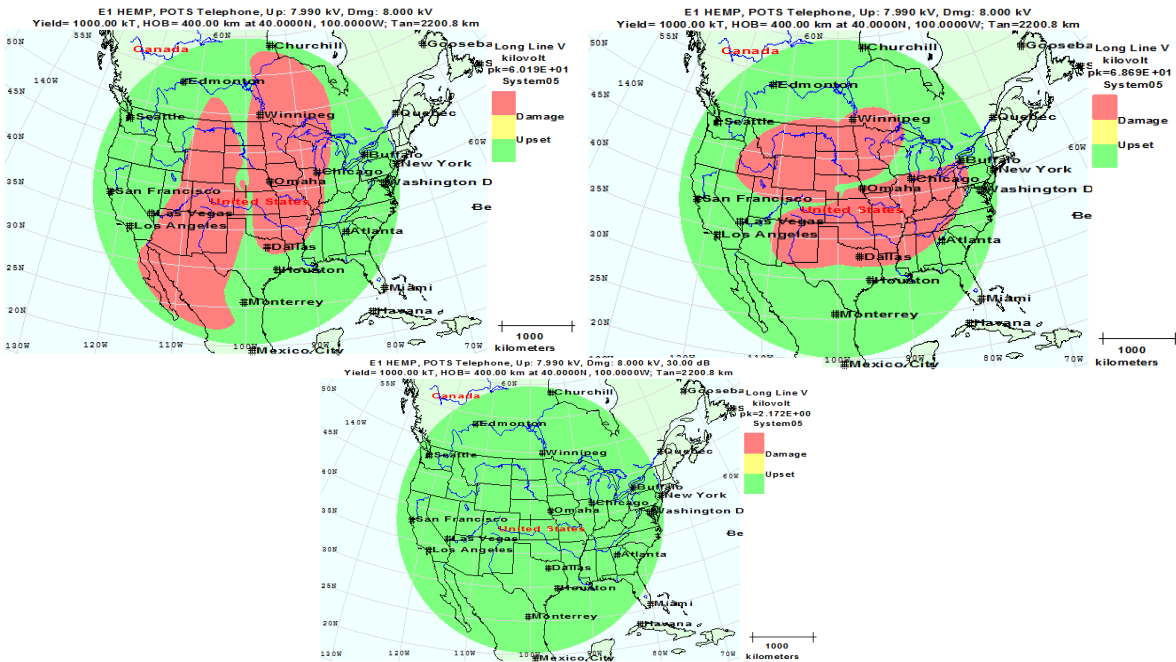

Figure 4. Protective effects on a Plain Old Telephone Service (POTS) Line achieved with 30 dB minimum recommended shielding.



## Level 4 EMP Protection Guidelines

### **EMP Protection Level 4 Summary (where only seconds of mission outage is acceptable):**

Use Military EMP Standards (MIL-STD-188-125-1 & MIL-HDBK-423), and 80+ dB hardening thru 10 GHz. Use EMP/RFW shielding in rooms, racks, and/or buildings to protect critical equipment. Use EMP SPDs to protect equipment outside of shielded areas. Use EMP protected double-door entryways. Have 30+ days of supplies & EMP protected back-up power (to include on-site fuel) for critical systems. Don't rely on commercial Internet, telephone, satellite, or radio nets that are not EMP protected for communications. Use Appendix A for EMP Protection Test and Acceptance Criteria. Use EMP protected fiber, satellite, & radio links & Appendix B services.

The military standard for the electromagnetic barrier design is MIL-STD-188-125-1 [see Reference 1], which specifies the following hardening program elements for the protection of HEMP:

#### **1. The facility shield.**

The facility electromagnetic (EM) shield is a continuous conductive enclosure that meets or exceeds specified shielding effectiveness requirements. In MIL-STD-188-125-1 this requirement is generally 80 dB up to 1 GHz. For this document we recommend that this requirement of 80 dB be extended to 10 GHz, which will also protect against the IEMI threat; in addition, this level and frequency range is achievable for shielded rooms constructed by industry today.

#### **2. Shield penetrations or points of entry (POEs) including wire penetrations, conduit/pipe penetrations, doors, and apertures.**

The number of shield POEs is limited to the minimum required for operational, life-safety, and habitability purposes. Each metallic cable POE is protected with a current limiting device that satisfies the standard's performance requirements.

#### **3. HEMP Shield and POE testing.**

The standard requires protection performance certification by testing. The protection program includes quality assurance testing during facility construction and equipment installation, acceptance testing for the electromagnetic barriers, and verification testing of the completed and operational facility.

#### 4. Life Cycle Hardness Maintenance and Surveillance (HM/HS).

HM/HS is included in the facility planning, design, and construction phases to assure that hardness features stay intact over the life cycle of the protected facility and systems.

The guidance provided for Level 4 Protection draws heavily on this military standard and the accompanying implementation guidance provided in MIL-HDBK-423 [see Reference 2].

Although the primary method used over the years for protecting equipment from the effects of a HEMP event is to enclose all critical equipment within a steel-shielded electromagnetic (EM) barrier, alternative methods exist including the use of shielded boxes interconnected by non-metallic lines including optical fiber or fluidic control lines.

Generally, an EM barrier for Level 4 Protection is constructed using metal plate (copper, aluminum, and/or steel walls, ceiling, and floor) with all seams continuously brazed or welded. To be complete, the barrier must include treatments on all penetrations to limit currents on penetrating cables and electromagnetic fields incident on doors, windows, vents, and pipes. Figure 5 provides a conceptual representation of a complete EM barrier. For the shield portion of the barrier, steel plate is preferred over copper because of its superior shielding effectiveness at lower frequencies and its mechanical strength. MIL-STD-188-125-1 [1] provides more detailed requirements for EM barrier construction. Additional information on construction of EM protected facilities is also provided in the following military standards:

- MIL-STD-785 addresses reliability [3]
- MIL-STD-470 addresses maintainability [4]
- MIL-STD-2165 addresses testability [5]
- MIL-STD-729 addresses corrosion control [6]

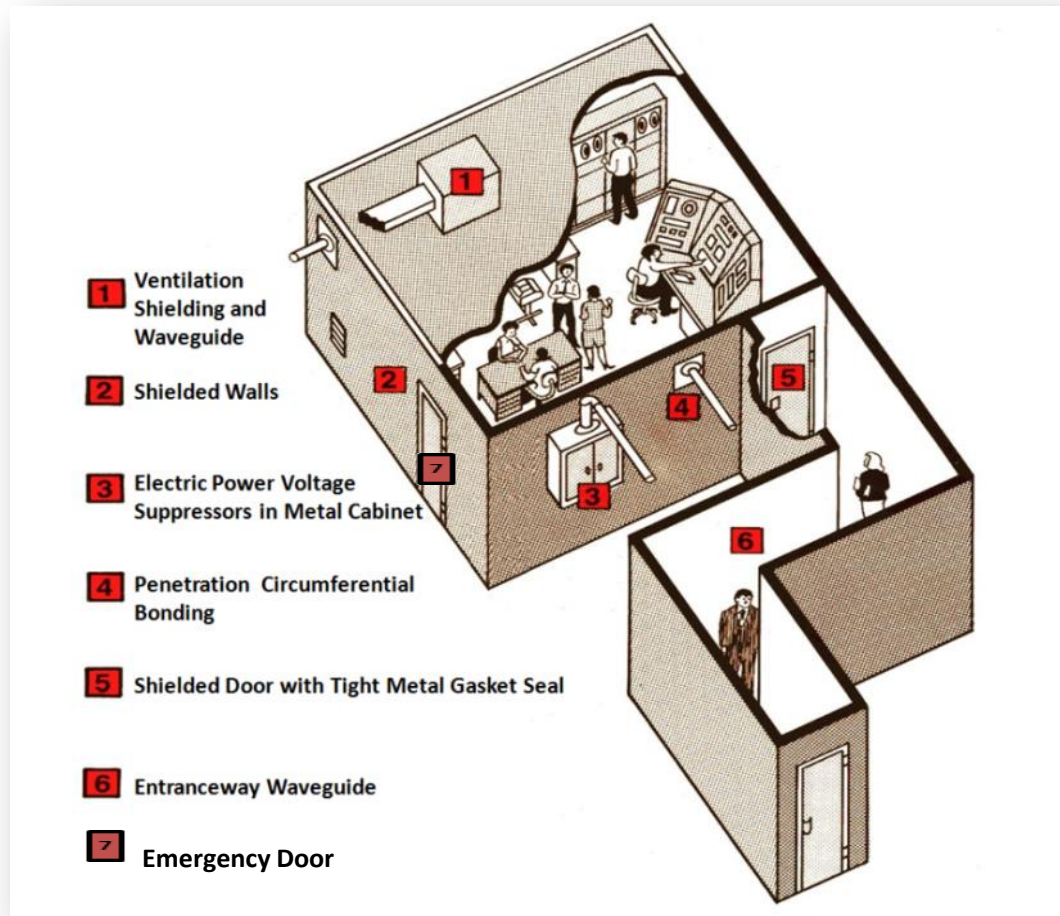

**Figure 5. Low-risk EMP barrier protection for facilities (per MIL-STD-188-125-1)**

The installation of an EM protection barrier provides a level of immunity to multiple electromagnetic environments for electronic equipment. Specifically, the EM barrier diverts any harmful electromagnetic fields away from mission critical systems. In addition to providing a shield against EMP, the barrier diverts SREMP and lightning currents to ground, provides a sharing path for GMD long-line currents, provides immunity to external electromagnetic interference (EMI) and IEMI environments, and contains classified emissions (provides TEMPEST protection). The barrier shield also acts as an excellent ground for internal systems, and, if good contact is made with earth ground, an excellent grounding surface for nearby external systems.

The EM barrier provides an electromagnetically isolated environment that enables commercial-off-the-shelf (COTS) equipment and systems with no special EM protection to be incorporated within the shielded facility. If the shield is maintained over time, the EM barrier greatly simplifies interior system upgrades and configuration management as systems are moved or replaced. This shifts the focus of system configuration control to maintaining the integrity of the EM barrier.

## 1. Six-sided electromagnetic shield barrier

Shielding will be in accordance with MIL-STD-188-125-1 [see Reference 1], and related military standards. The shield barrier should be constructed using 3-6 mm thick welded steel sheeting, which provides at least 80 dB of shielding. Copper or other materials may be used if they can provide the required shielding effectiveness and are fully compatible with the POE protective treatments and grounding requirements. Steel is preferred because of its superior shielding effectiveness at low frequencies and its mechanical strength. Using metal screen or wire mesh for the barrier presents problems related to inadequate inherent shielding properties at lower and higher frequencies and presents problems relating to circumferentially bonding cable conduits, vents, and piping penetrations to mesh/screen materials.

## 2. Protection of barrier breaches and cable/piping points of entry (POEs)

Treatment of Protection Barrier Breaches and POEs will be in accordance with MIL-STD-188-125-1 [1], and related military standards. The number of shield breaches and cable/piping POEs should be limited to the minimum required for mission operation, life-safety, and habitability purposes. As a design objective, there should be a single penetration entry area on the electromagnetic barrier for all piping and electrical POEs except those connected to external conductors less than 10 m (32.8 ft.) in length. To eliminate cross coupling, the penetration entry area should be located as far from normal and emergency personnel and equipment accesses and ventilation breaches in the shield, as is permitted by the facility floor plan. Each POE should be “treated” with a POE protective device. Guidance for specific types of penetrations follows.

**Electrical POEs.** EM protection for electrical POEs, including all power, communications, and control penetrating conductors whether shielded or unshielded, should be provided with main barrier transient suppression/attenuation devices. The main barrier transient suppression/attenuation devices should consist of filters (linear elements) and surge arresters (nonlinear elements), as required to satisfy the shielding effectiveness requirements and residual transient limiting requirements. Figure 6 illustrates a typical cable POE protection design including filters and surge arresters. POE protection should be installed in a manner that does not degrade the shielding effectiveness of the facility EM shield.

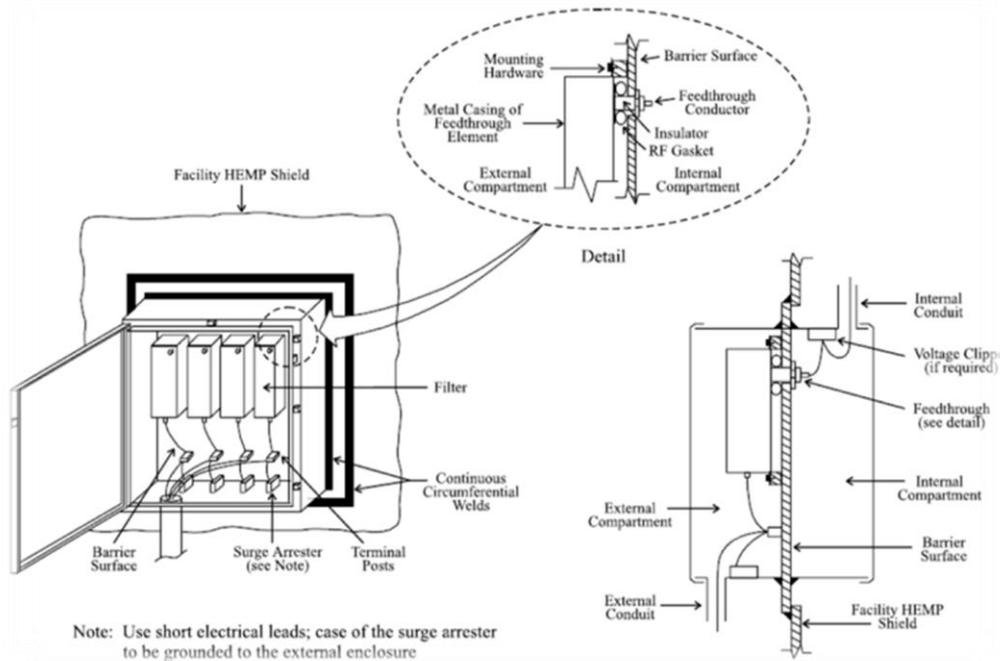

Figure 6. Typical cable POE protection design

In the case of audio and data line penetrations through the shield, it is highly recommended that fiber-optic signal lines be used exclusively. Likewise, if possible, bring radio antenna signals into the barrier-protected space using fiber optic cables by employing copper-to-fiber converters outside of the barrier. In all cases fiber optic cables that penetrate the shield must use a metallic WBC.

With regard to electrical power service and associated barrier penetrations, the facility should be provided with a backup EM-hardened electrical power generation and distribution capability sufficient to perform missions, without reliance upon commercial electrical power sources. It is highly recommended that the necessary electric power source be installed within the barrier. In cases where external power sources are necessary or if internal power sources are used to power external equipment, individual power feeder lines should be protected by installing an electrical surge arrester (ESA) and a low pass filter within a shielded compartment or “ESA vault” (see Figure 7) at both ends of these power cables. These commercial power “filters” are available and meet the requirements of MIL-STD-188-125-1. Commercial distribution transformers external to the EM barrier should have surge arresters installed to protect these transformers from lightning damage. The facility should be designed to operate for a significant time using backup power in case the external transformers are damaged.

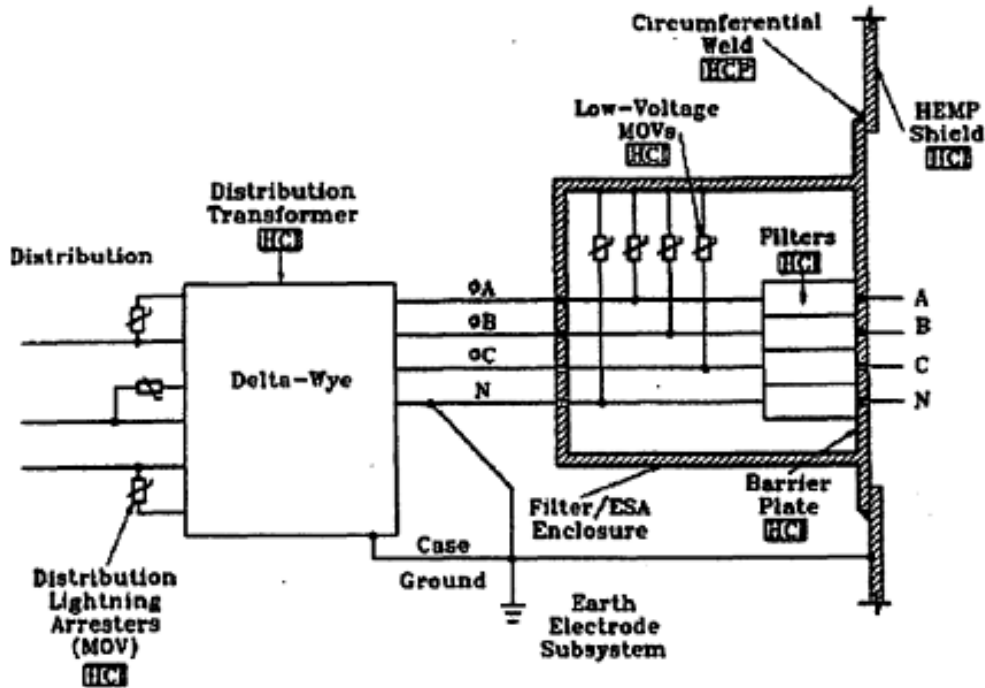

Figure 7. Integrated electric power feeder POE protection

Metallic commercial power entering a critical facility or room that is closer than 50 miles to an urban center with 50,000 or more people (and hence, more likely to be subject to SREMP long line current threats) should be electrically isolated from the power grid either through physical separation (disconnection while operating on backup power during periods of heightened threats) or through the use of both an isolation transformer and the use of motor generators outside of the shielded facility or room, etc. As an alternative, fuel cell power technology has been considered in the past for this problem with the fuel passed through the shield. See Figure 8 to see an example of a power line POE protection approach using a motor-generator set. The input power connection drives a motor external to the EM barrier shield connected to a generator by a dielectric shaft penetrating the shield wall within a WBC. A typical installation would use a flywheel on the motor to electromechanically filter power line disturbances and provide a short, few second UPS function. The primary advantage of a motor-generator set is that there are no metallic power penetrations through the shield. As a result, the motor-generator set provides protection against SREMP, injection-type EM weapons, as well as HEMP (although the essential need for this type of protection is for SREMP). If properly maintained, a motor-generator set can last for more than two decades. The only requirement is to protect the motor against naturally occurring power line transients, such as lightning. This can be accomplished with a Transient Voltage Suppression System (TVSS) usually consisting of MOVs installed at the power input to the motor. In addition the power line entry to the external motor and any external controls for its operation must be protected against the full set of EMP transients. This is also true if a fuel cell system were used.



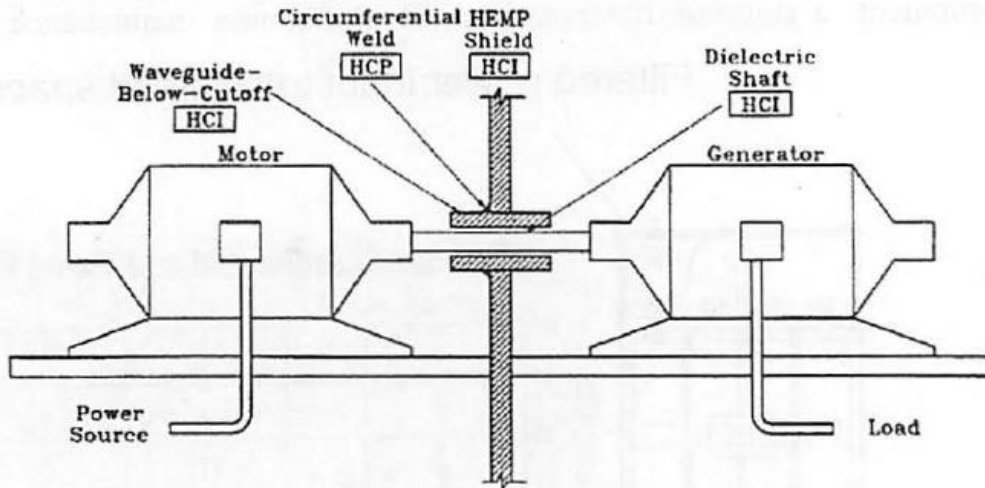

Figure 8. Power line POE protection using a motor-generator set

**Personnel and utility breach-type POEs.** For personnel entryways, two designs are permissible. The first uses double doors separated by a shielded waveguide-below-cutoff (WBC) vestibule as illustrated in Figure 9a (including a door interlock). This design provides additional protection for frequencies below  $\sim 50$  MHz, although for higher frequencies the waveguide alone is not sufficient. The interlock is needed to ensure that E1 HEMP fields above 50 MHz do not scatter through the waveguide and also the IEMI fields that extend up to 10 GHz do not enter the Facility HEMP Shield when both doors are open. The second uses two doors separated by a metal-enclosed vestibule with an interlock to ensure that only one door is open at a time (Figure 9b). This approach is the best in order to deal with all of the EMP threats. In either case, inflatable gaskets or metal fingerstock should be used to ensure electromagnetically tight door seals.

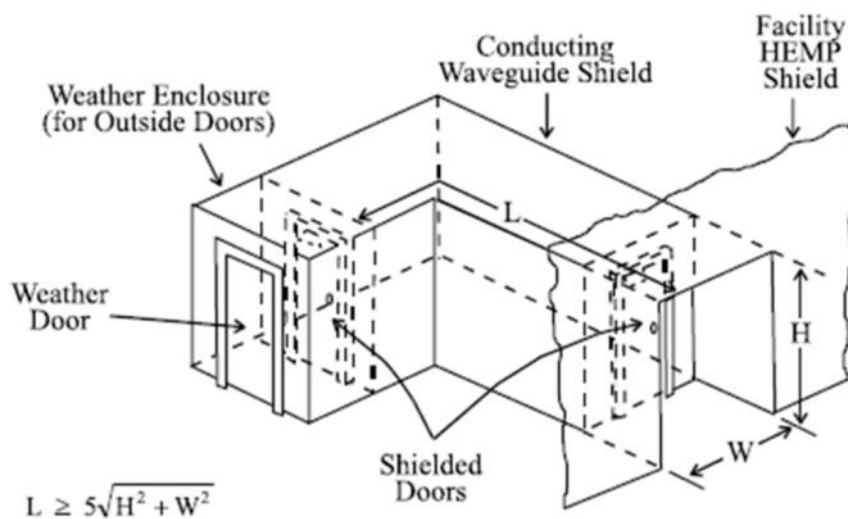

Figure 9a. Entryway using two doors separated by a WBC

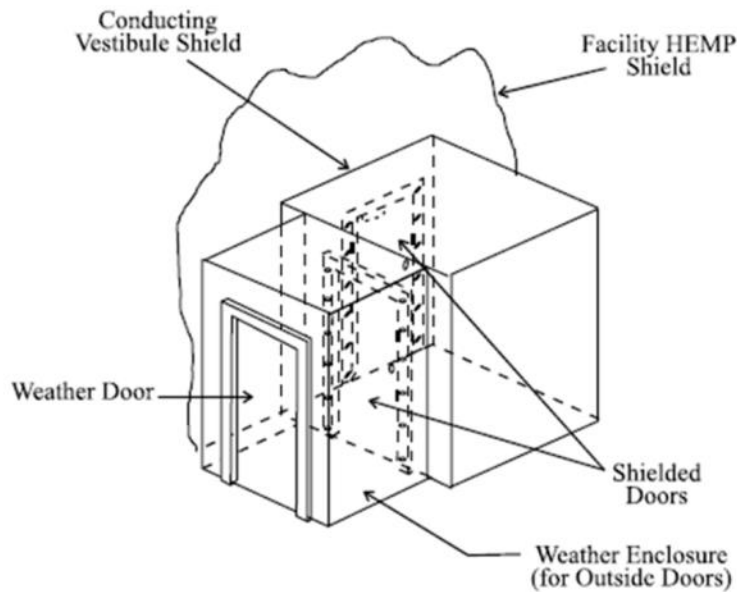

Figure 9b. Vestibule entryway with door interlocks

In the case of barrier penetrations to accommodate utility pipes and conduits, one should circumferentially weld any metal pipe or conduit penetrations at the exterior surface of the metal shield. Waveguide-Below-Cutoff (WBC) designs for air vents and pipes are illustrated in Figures 10a and 10b. The cutoff frequency for air filled waveguides can be estimated as  $f_c (\text{Hz}) = 1.5 \times 10^8 / d$ , where  $d$  in meters is the largest dimension of a rectangular waveguide or the diameter of a circular waveguide. Given the cutoff frequency, the length of the waveguide needs to be greater than 5 times the largest transverse dimension of the waveguide. It should be noted that for ventilation pipes, while a 10 cm diameter is adequate for HEMP purposes, waveguide dimensions of 1 cm are needed to protect against IEMI threats. Industry typically makes ventilation waveguides that are effective up to 18 GHz, satisfying IEMI and TEMPEST requirements in addition to E1 HEMP. It is noted however, that if TEMPEST is not a requirement for a given facility, there are some advantages in not requiring a very small waveguide dimension especially in the case where hot exhaust air is involved, or if a high level of air flow is needed.



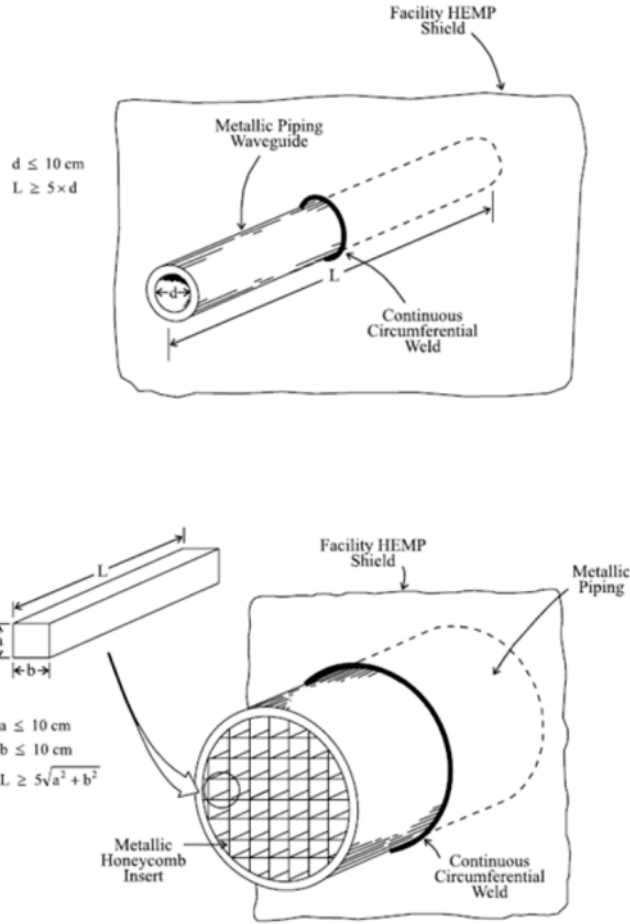

Figure 10a. Typical waveguide-below-cutoff (WBC) piping POE protective design for E1 HEMP

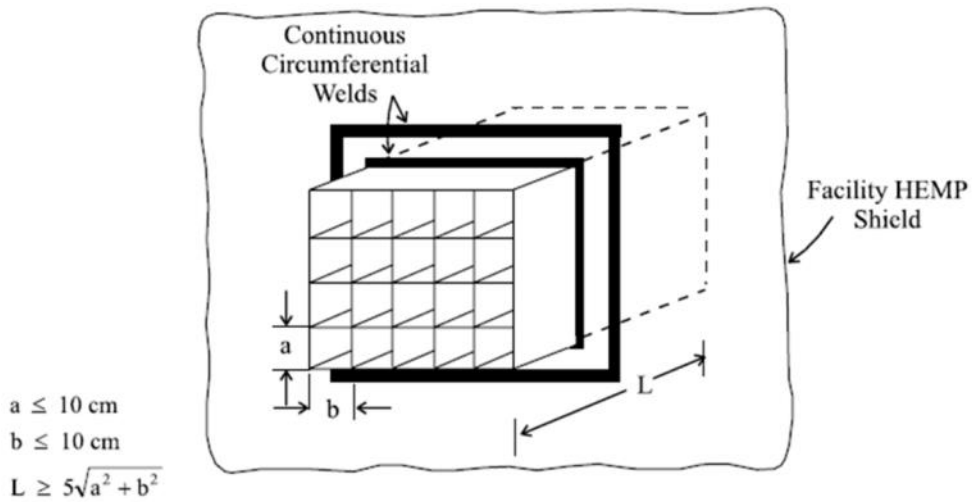

Figure 10b. Typical waveguide-below-cutoff ventilation POE protective design for E1 HEMP

### **3. Designation of Mission Critical Systems (MCS)**

MCS include such items as communications electronics equipment, data processing equipment, supervisory control and data acquisition (SCADA) systems, local portions of hardened network interconnects, and critical support subsystems such as power generation, power distribution, transformers, and environmental control systems. All MCS, with the exception of equipment that must access the external environment (e.g. antennas and heat exchangers), should be installed within the electromagnetic barrier.

MCS such as radio antennas, evaporative heat exchangers, or external security sensors that must be placed outside the electromagnetic barrier should be provided with special protective measures, as required, to ensure hardness against electromagnetic effects. Special protective measures should be implemented in cases where electromagnetic hardness cannot be achieved with the electromagnetic barrier alone. Special protective measures include additional shielding, additional transient suppression/attenuation devices, fiber optic cables, and equipment-level protection required to achieve electromagnetic hardness. To facilitate life cycle system hardness maintenance, surveillance, and configuration management, it is important to minimize the number of subsystems requiring special protective measures. The three categories requiring special protective measures are as follows:

- MCS that must be located outside the electromagnetic barrier and, therefore, are not protected by the barrier.
- MCS that are enclosed within the electromagnetic barrier and experience mission aborting damage or upset during verification testing, even though the barrier elements satisfy all performance requirements. (It is noted that this is an exceptional situation that normally indicates that there is in fact a failure of a barrier element.)
- Special protective volumes and barriers to provide supplementary isolation, when POE protective devices cannot satisfy the barrier requirements without interfering with facility operation. (This often occurs when it is not possible to prevent in-band HEMP, SREMP or IEMI penetration on antenna lines leading to a transmitter inside the barrier; in this case it is recommended to build a special shielded area for the transmitter equipment inside of the barrier.)

### **4. Electromagnetic shield barrier grounding**

The barrier grounding practices described here apply to HEMP, SREMP, EM weapons, and lightning. The grounding required for these effects are part of the total facility-grounding network. The ultimate path to ground is the earth electrode subsystem. Protection against these EM effects is imperative for sensitive electronic equipment to ensure a survivable and interference-free system. Grounding for this protection interfaces with each of the major subsystems. The lightning subsystem and its earth grounding electrode subsystem are the main interfaces with the EM protection system. It is, important that the grounding

system be properly designed and constructed to provide the most direct and lowest possible impedance to the earth ground at all frequencies of interest.

The barrier shield exterior should be multi-point grounded to a buried earth electrode system at the corners of the barrier and at 20 foot intervals around the perimeter of the barrier [7-8] (see Figure 11). This approach is particularly important if the shield barrier is not in direct contact with the soil under the facility (when there is soil contact, the shield is grounded in a low inductance fashion providing an excellent path for high-frequency currents on the shield to flow to ground). This buried earth electrode system should also be used as the common ground counterpoise for the EM protection systems of external equipment. Ground straps or cables used to connect the barrier shield to the earth electrode subsystem should be electrically bonded to the external surface of the barrier shield. At least one such low-inductance ground strap, cable or plate should be located at each penetration entry area. Grounds for equipment and structures outside the barrier shield should be electrically bonded to the outside surface of the barrier shield or to the buried earth electrode subsystem.

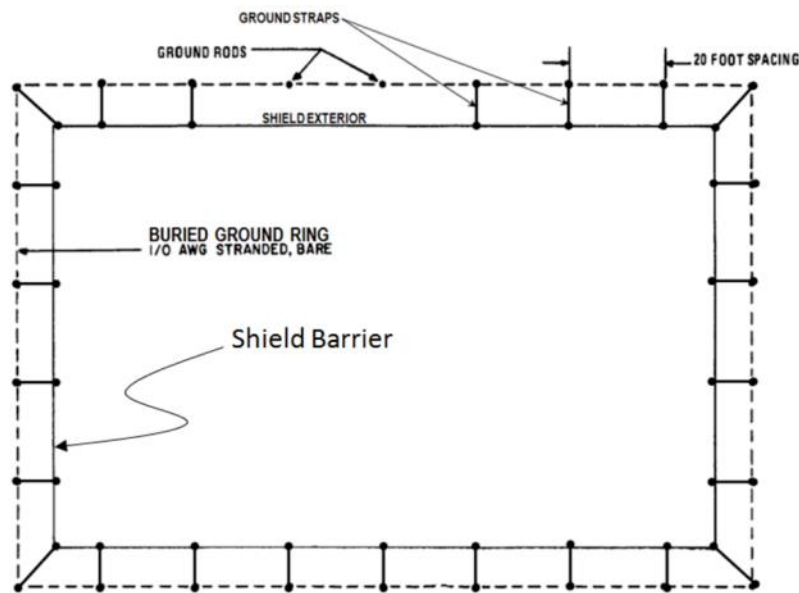

Figure 11. Shield barrier earth electrode system

Grounds for equipment and structures enclosed within the protected volume should be electrically bonded to the inside surface of the shield. Internal equipment should be single-point grounded to the inside of the barrier shield to avoid inductive ground loops, although this aspect is not critical if the shield reduces the external fields correctly. It is a concern for equipment not inside of a shielded volume. All grounding connections to the facility EM shield should be made in a manner that does not create POEs by breaching the shield.

## 5. EM Barrier Hardness Validation Testing

EM barrier testing is important to ensure the integrity of the shield and the POE protection. The testing should include quality assurance testing during facility construction and equipment installation, acceptance testing for the electromagnetic barrier and special protective measures, and verification testing of the completed and operational facility.

Initial EM protection acceptance testing. Initial certification of the EM barrier protection effectiveness should be based upon successful demonstrations of compliance with shielding effectiveness (SE) tests for the barrier and pulsed current injection (PCI) tests of conducting penetrations. Initial acceptance tests of the electromagnetic barrier and special protective measures should be conducted after all related EM barrier shield and PoE construction work has been completed. Initial acceptance test procedures and results should be documented and retained for use as hardness maintenance and surveillance (HM/HS) baseline configuration and performance data.

Operational verification testing. After completion of the EM protection subsystem and installation, operational checks, and installation/acceptance of all system equipment, the EM hardness of the facility should be verified through a program of tests and supporting analysis. The verification program should result in a definitive statement that the critical time-urgent mission functions of the barrier and its contents are certified to withstand exposure to the EM effects of concern. Verification test procedures and results should also be documented and retained for use as hardness maintenance and surveillance (HM/HS) baseline configuration and performance data.

Validation testing types. Both initial acceptance testing and operational verification testing include (1) shielding effectiveness tests, (2) pulsed current injection testing of electrical POEs and (3) grounding system tests.

(1) **Shielding effectiveness testing** is used to certify that the facility EM shield, with all POE protective devices installed, provides at least the minimum shielding effectiveness shown in Appendix A, Figure A1 for HEMP (80 dB up to 1 GHz). This protection level is sufficient for the radiated fields associated with SREMP. To extend the protection to encompass the threat of EM weapons producing IEMI, it is recommended that the shielding effectiveness requirement be extended at the 80 dB level up to 10 GHz. Shielding effectiveness testing should be conducted with barrier POEs and their protective devices in a normal operating configuration, using shielding effectiveness test procedures described in Appendix A of MIL-STD-188-125-1 [1].

(2) **HEMP pulsed current injection (PCI) testing** is well prescribed and involves injecting the pulses prescribed in Appendix A, Table A1 of this document for each electrical POE. This baseline testing for HEMP gives confidence that POE protection will withstand HEMP, radiated SREMP and EM weapon threats up to 1 GHz. To extend the PCI testing to higher frequencies, the IEC has developed test waveforms for EM threats above 1 GHz [9]. The EM

barrier passes the test if the POE protective devices attenuate voltages and currents measured inside the shield to the upper bound levels prescribed for each class of electrical POE (as provided in Appendix A, Table A2). Additionally, the main barrier protective device should be rated to withstand a sufficient number of test pulses at the prescribed peak injection current without damage or unacceptable performance degradation to accommodate life cycle testing.

(3) **Ground system testing.** The resistance to earth of the earth electrode subsystem should be tested using the fall-of-potential method. The completed grounding system should be “Megger tested” at the service disconnect enclosure grounding terminal, and at earth electrode system ground test wells. Measure ground resistance not less than 2 full days after the last trace of precipitation, and without the soil being moistened by any means other than natural drainage or seepage and without chemical treatment or other artificial means of reducing natural ground resistance. It is recommended that the tests be performed using the two-point method according to IEEE 81 [10], “Guide for Measuring Earth Resistivity Grounding Impedance and Earth Surface Potentials of Ground Systems.” Unless otherwise specified by facility drawings, the earth ground resistance should be 10 ohms or less.

## 6. Hardness Maintenance and Hardness Surveillance (HM/HS)

A built-in test capability should be installed to at least qualitatively monitor for electromagnetic shield leakage. The built-in shield monitoring system should include:

- Radiating antenna(s) external to the barrier shield
- Receiving antenna(s) internal to the shield
- Test control, antenna source, and data analysis electronics inside the shield

To facilitate HM/HS, the barrier shield design should include a crawl space underneath the shield floor to enable inspection for floor plate defects due to maintenance and/or corrosion and shielding effectiveness testing. On the other hand, if the barrier shield floor can be constructed in direct contact with the soil, high frequency currents induced on the other 5 sides of the shield will be severely attenuated at the soil/barrier interface.

## 7. Treatment of Mission Critical Systems outside the EM barrier

For MCS that must be located outside of the barrier shield, special protective measures should be implemented to ensure effective EM protection. Special protective measures for MCS outside the main barrier may include:

- Cable, conduit, and local volume shielding
- Linear and nonlinear transient suppression/attenuation devices

- Equipment-level hardening (reduced coupling cross-section, dielectric (e.g. fiber optics) means of signal and power transport, use of inherently robust components)
- Moving sensitive circuits associated with external MCS to locations within the protected volume
- Automatic recycling features or operator intervention schemes, when the mission timeline permits
- Other hardening measures appropriate for the particular equipment to be protected

Performance requirements for the special protective measures should ensure that the highest EMP-induced, peak time domain current stresses reaching the equipment are less than the vulnerability thresholds of the equipment.

RF communications antennas outside the main electromagnetic barrier and any associated antenna-mounted electronics, tuning circuits, and antenna cables located outside the main electromagnetic barrier should be treated as MCS that are placed outside the electromagnetic barrier. Performance requirements for the EM protection should ensure that the highest EM threat-induced peak time domain current stresses at the antenna feed are less than the vulnerability thresholds of the MCS located outside the barrier.

Front door in-band protection is one of the more challenging (but not insurmountable) EM protection problems. The high gains associated with most “front door” coupling paths make these potentially the most susceptible portion of radio communication systems. However these well-characterized front door receive paths have been the subjects of much attention in terms of protection engineering. Radar systems are often protected from their own or neighboring transmitters by a receiver protector or RP. Similar protection can be applied to communication receivers against in-band EM weapon environments. A typical RP uses plasma and diode limiter stages. At a given threshold the most sensitive diode turns on, forming a shunt across the waveguide. At higher energies, the other stages activate in parallel. The plasma “vial” stages turn on at the highest powers through a process similar to air breakdown and are capable of diverting large amounts of energy to ground without damage. Most vial limiters use halogen gas as the breakdown medium. If the system is transmitting, it will be necessary to unkey the transmitter to extinguish the ignited plasma devices. As an example, the schematic of a Westinghouse RP design is provided in Figure 12.

Effective and robust waveguide filters are available for out-of-band front door EM weapon environments. The challenge is to provide protection at the same time minimizing insertion loss effects on normal operation.

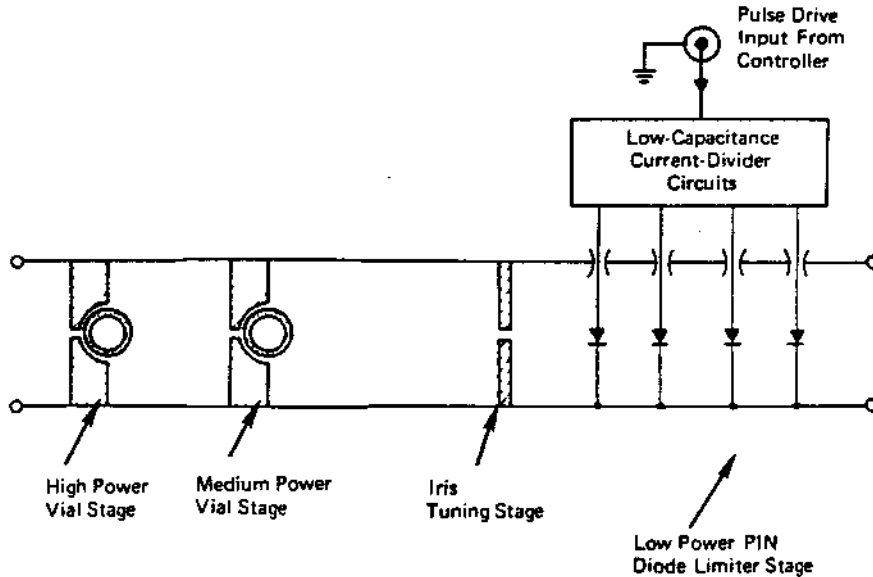

Figure 12. Example receiver protector unit diagram

## 8. Special protective volumes

Special protective volumes for piping POEs. When a pipe POE diameter must be larger than  $1/5$  of the pipe's length and a WBC array insert cannot be used (per Figure 7a), a special protective volume should be established inside the electromagnetic barrier (see figure 13a). The protective volume should include a special protective barrier that should completely enclose the non-compliant piping. The protective volume should be protected at the barrier shield outer wall using the WBC technique having a cutoff frequency of at least 1.0 GHz for HEMP and SREMP, but should extend to 10 GHz for IEMI and 18 GHz for TEMPEST. The special protective barrier may be a separate shield with protected penetrations, or it may be implemented by extending the metal walls of the piping system itself (figure 13a). Performance requirements for the special protective barrier should ensure that the total shielding effectiveness, measured through the main electromagnetic barrier and special protective barrier, satisfies at least the minimum requirements shown on Appendix A, figure A1.

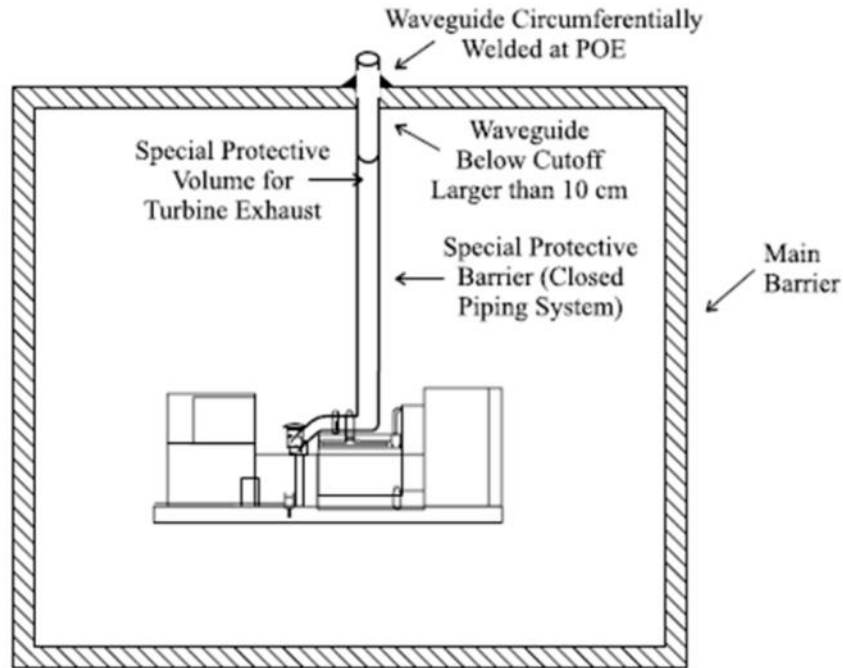

Figure 13a. Special protective volume for piping POE for E1 HEMP

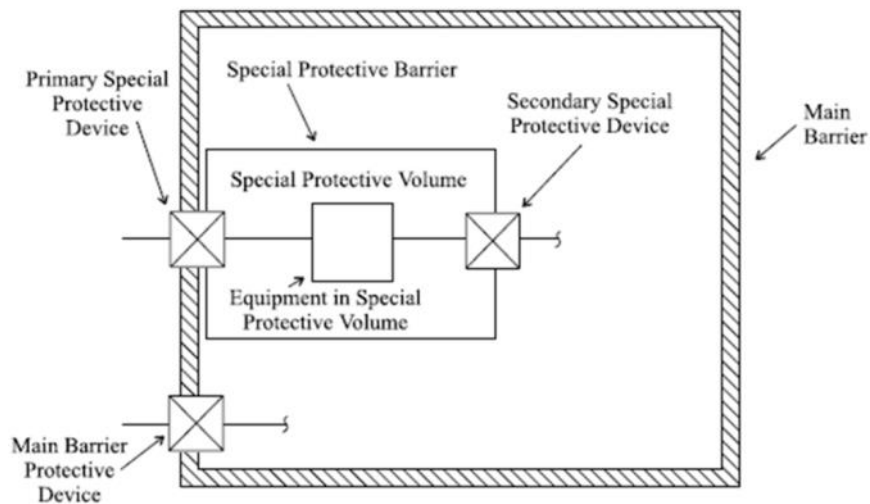

Figure 13b. Special protective volume for electrical equipment

Special protective volumes for electrical POEs. When a main barrier protective device cannot be designed to achieve the transient suppression/attenuation performance prescribed for the particular class of electrical POE without interfering with operational signals it is required to pass, a special protective volume should be established inside the main electromagnetic barrier (figure 10b). A special protective volume should be enclosed by a special protective barrier with primary and secondary special electrical POE protective devices, as required to meet the performance requirements prescribed. The special



protective barrier should completely enclose wiring and equipment directly connected to a primary special electrical POE protective device. The special protective barrier may be a separate shield, or it may be implemented using cable and conduit shields and equipment cabinets. Performance requirements for the special protective barrier should ensure that the total shielding effectiveness, measured through the main electromagnetic barrier and special protective barrier, satisfies at least the minimum requirements shown on Appendix A, Figure A1.

Secondary special electrical POE protective device requirements. When the combination of the primary special electrical POE protective device and the directly connected equipment cannot be designed to achieve the transient suppression/attenuation performance prescribed for the class of electrical POE (per Appendix A, Table A2), a secondary special electrical POE protective device should be used (see figure 10b). The secondary special electrical POE protective device should be designed so that the total transient suppression/attenuation, measured through the primary special protective device, the connected equipment, and the secondary special protective device, satisfies at least the minimum requirements prescribed for the class of POE without device damage or performance degradation.

Mission Critical Systems (MCS) in a special protective volume. Special protective measures should be implemented as necessary to harden MCS in a special protective volume to the EM-induced stresses that will occur in that volume. Special protective measures for MCS in a special protective volume may include cable, conduit, and volume shielding; fiber-optic cables; transient suppression/attenuation devices; equipment-level hardening; remote locating of sensitive circuits; automatic recycling or failover; operator intervention features; and other hardening measures appropriate for the particular equipment to be protected. Performance requirements for the special protective measures should ensure that the highest EM-induced peak time-domain current stresses reaching the equipment are less than the vulnerability thresholds for the equipment. Adequate WBC EM attenuation occurs if the length (L) is greater than  $5\sqrt{H^2 + W^2}$  where H is the height and W is the width of the conduit or passageway.

## **9. Special Protection at the box level**

While a facility-level barrier (“global” shielding and POE protection) is preferred, there are situations where box-level protection is expedient or necessary. A conceptual diagram of global vs. box-level protection appears in Figure 14.

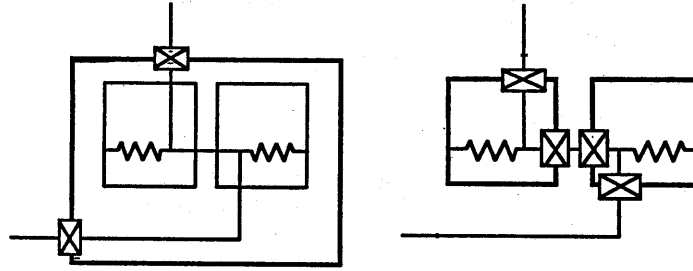

Figure 14. Global barrier vs. box-level protection

A complete facility EM barrier gives the highest confidence protection. Its effectiveness is easy to verify using CW field illumination, which facilitates initial protection certification and HM/HS activities. It is the preferred method for critical systems where internal electronic boxes are being changed or upgraded often. It has been successfully implemented for the HEMP protection of the U.S. backbone communication and strategic missile systems. However, for many systems global shielding may impose unacceptable cost and weight increases.

Box level protection can be very effective, especially in the case where only a few pieces of equipment are critical. Well-designed electronic boxes using RF gaskets and cable treatment have been demonstrated to be very effective to the point that internally coupled RF levels are indistinguishable from noise levels. Cables must be well shielded with high quality connectors circumferentially bonded to the cable shield. Fiber optic interconnecting cables are the best engineering solution. Box level hardening techniques are depicted in Figure 15.

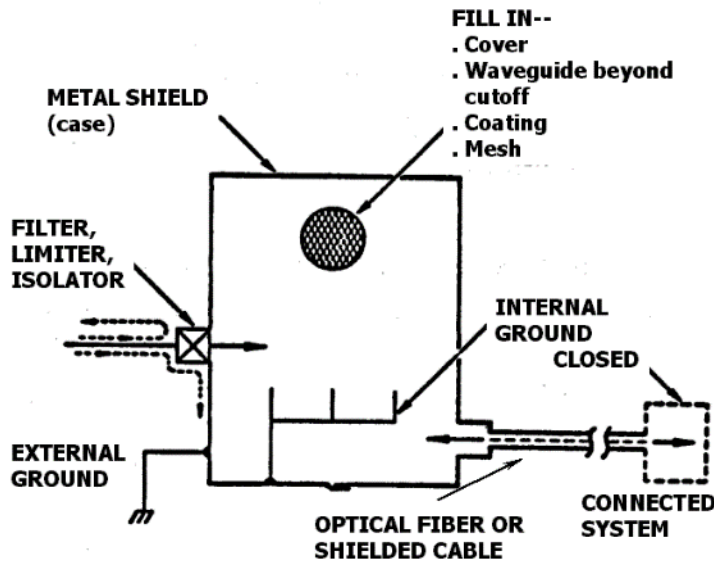

Figure 15. Box-level hardening techniques

**10. Multiple shielded buildings or shielded volumes connected by conduits**

EMP protection for cables running between two shielded facilities or rooms may be provided by using continuous conduit shielding or highly shielded and tested cables, when the lengths of the runs do not exceed the applicable maximums provided in Table 2 that follows.

**11. Uninterruptible power supply (UPS) considerations**

When selecting a UPS for protecting equipment from EMP, it is recommended that a true on-line, double-conversion type of UPS be used. As this UPS will be installed inside the shielded volume, there is no concern over high frequency transients. However, the UPS selected should have been tested against high harmonic currents and voltages (especially the 2<sup>nd</sup> harmonic), which is generated during E3 HEMP and/or GMD events.

**Table 2. HEMP Specifications for cable runs between two protected rooms**

Type of Cable Run and Conduit	Maximum Conduit Length (m)		
	5 cm ≤ OD < 10 cm	10 cm ≤ OD < 15 cm	15 cm ≤ OD
Signal and Low Current Power Lines	37	75	112
Buried Conduit	6	12	18
Nonburied Conduit			
Medium Current Power Lines			
Buried Conduit	200	600	1120
Nonburied Conduit	60	120	180
High Current Power Lines			
Buried Conduit	200	600	1,200
Nonburied Conduit	200	600	1,200

Main barrier ESAs and filters are not required on the penetrating conductors under conditions where cable runs are shorter than shown in Table 2 and the conduit or cable is bonded to the shields at both ends. With respect to the terminology in Table 2, any cable run containing one or more control or signal conductors is considered to be a signal line. A power cable run containing one or more conductors with maximum operating currents less than 1.0 A is considered to be a low current power line. A power cable in which the maximum operating current on the lowest rated conductor is between 1.0 A and 10 A is considered to be a medium current power line. A power cable run containing only power lines with operating currents greater than 10 A is considered to be a high current power line. A conduit is considered “buried” when no more than 1 m (3.3 ft.) of its total length is not covered by earth or concrete fill; it is “nonburied” if 1 m (3.3 ft.) or more of the total conduit length is not covered.

1. Conduit design requirements. EMP protection conduits should be rigid metal conduits, with circumferentially welded, brazed, or threaded closures at all joints and couplings, pull boxes, and at both ends of penetrations through the facility EMP shields.
2. Conduit certification test requirements. A pulsed current injection (PCI) source, producing an 800-A short-circuit current on a buried signal or low current power line conduit and a 5000-A short-circuit current on a nonburied signal or low current power line conduit, 20 ns risetime and 500-ns pulse width (full width at half maximum), and source impedance  $\geq 60 \Omega$ , should produce a residual internal transient stress no greater than 0.1 A on the wire bundle inside the conduit.

The same PCI source connected on the outer surface of a medium or high current power line conduit should produce a residual internal transient stress no greater than 10 A, when the operating current on the lowest rated conductor in the wire bundle inside the conduit is greater than 10 A, and no greater than 1.0 A when the operating current is between 1.0 A and 10 A.

If a multiconductor shielded cable can be tested in the laboratory to the pulses described in item 2) above, and it can achieve the required peak residuals, then a shielded cable can be used instead of a conduit.

## Acronyms

AC/DC	Alternating Current/Direct Current
AM	Amplitude Modulation
CCMG	Continuity Communications Managers Group
COTS	Commercial off the shelf
dB	Decibel
DTRA	Defense Threat Reduction Agency
DTV	Digital Television
EM	Electromagnetic
EMAT	Electromagnetic Assessment Tool
EMI	Electromagnetic Interference
EMP	Electromagnetic Pulse
ESA	Electrical Surge Arrester
FM	Frequency Modulation
GETS	Government Emergency Telecommunications Service
GMD	Geomagnetic Disturbance
HCI	Hardness Critical Item
HEMP	High-Altitude Electromagnetic Pulse
HF	High Frequency
HM/HS	Hardness Maintenance/Hardness Surveillance
HOB	Height of Burst
HV	High Voltage
HVAC	Heating, Ventilation, and Air Conditioning
IC	Integrated Circuit
IEC	International Electrotechnical Commission
IEEE	Institute of Electrical and Electronics Engineers
IEMI	Intentional Electromagnetic Interference
IMT	Infrastructure Mapping Tool
IND	Improvised Nuclear Device
IT	Information Technology
ITU	International Telecommunication Union
IRA	Impulse Radiating Antenna

km	kilometers
kT	Kiloton
kV/m	Kilovolts/meter
kW	kilowatt
MCS	Mission Critical Systems
MHD	Magneto hydrodynamic
MOV	Metal Oxide Varistor
MT	Megaton
NB HPRF/M	Narrowband, High Pulse Repetition Frequency mode Microwave
NCC	National Coordinating Center for Communications
OEC	Office of Emergency Communications
PBX	Public Branch Exchange
POE	Point of Entry
POTS	Plain Old Telephone System (wireline)
RFW	Radio Frequency Weapon (RFW)
RP	Receiver Protection
SCADA	Supervisory Control and Data Acquisition
SHARES	SHARed RESources
SPD	Surge Protection Device
SREMP	Source Region Electromagnetic Pulse
TBB	Telecommunications Bonding Backbone
TEMPEST	Transient Electromagnetic Pulse Emanation Standard
TPD	Terminal Protection Device
TRX	Transceiver
TSP	Telecommunications Service Priority
TVSS	Transient Voltage Suppression System
UHF	Ultra High Frequency
UPS	Uninterruptible Power Supply
USSR	Union of Soviet Socialist Republics
UWB	Ultra-wideband
VHF	Very High Frequency
WBC	Waveguide below cutoff
WPS	Wireless Priority Service

## Bibliography

Publications dealing with the protection of civil equipment and systems from the effects of HEMP and IEMI - Issued by the International Electrotechnical Commission (IEC) SC 77C as of 11 November 2016:

1. IEC/TR 61000-1-3 Ed. 1.0 (2002-06): Electromagnetic compatibility (EMC) – Part 1-3: General – The effects of high-altitude EMP (HEMP) on civil equipment and systems. Basic EMC publication.
2. IEC/TR 61000-1-5 Ed. 1.0 (2004-11): Electromagnetic compatibility (EMC) – Part 1-5: General – High power electromagnetic (HPEM) effects on civil systems. Basic EMC publication.
3. IEC 61000-2-9 Ed. 1.0 (1996-02): Electromagnetic compatibility (EMC) – Part 2: Environment – Section 9: Description of HEMP environment – Radiated disturbance. Basic EMC publication.
4. IEC 61000-2-10 Ed. 1.0 (1998-11): Electromagnetic compatibility (EMC) – Part 2-10: Environment – Description of HEMP environment – Conducted disturbance. Basic EMC publication.
5. IEC 61000-2-11 Ed. 1.0 (1999-10): Electromagnetic compatibility (EMC) – Part 2-11: Environment – Classification of HEMP environments. Basic EMC publication.
6. IEC 61000-2-13 Ed. 1.0 (2005-03): Electromagnetic compatibility (EMC) – Part 2-13: High-power electromagnetic (HPEM) environments – Radiated and conducted. Basic EMC publication.
7. IEC 61000-4-23 Ed. 1.0 (2000-10): Electromagnetic compatibility (EMC) – Part 4-23: Testing and measurement techniques – Test methods for protective devices for HEMP and other radiated disturbances. Basic EMC publication.
8. IEC 61000-4-24 Ed. 2.0 (2015-11): Electromagnetic compatibility (EMC) – Part 4-24: Testing and measurement techniques – Test methods for protective devices for HEMP conducted disturbance. Basic EMC Publication.
9. IEC 61000-4-25 Ed. 1.1 (2012-05): Electromagnetic compatibility (EMC) – Part 4-25: Testing and measurement techniques – HEMP immunity test methods for equipment and systems. Basic EMC publication.

10. IEC/TR 61000-4-32 Ed. 1.0 (2002-10): Electromagnetic compatibility (EMC) – Part 4-32: Testing and measurement techniques – High-altitude electromagnetic pulse (HEMP) simulator compendium. Basic EMC publication.
11. IEC 61000-4-33 Ed. 1.0 (2005-09): Electromagnetic compatibility (EMC) – Part 4-33: Testing and measurement techniques – Measurement methods for high-power transient parameters. Basic EMC publication.
12. IEC/TR 61000-4-35 Ed. 1.0 (2009-07): Electromagnetic compatibility (EMC) – Part 4-35: Testing and measurement techniques – High power electromagnetic (HPEM) simulator compendium. Basic EMC publication.
13. IEC 61000-4-36 Ed. 1.0 (2014-11): Electromagnetic compatibility (EMC) – Part 4-36: Testing and measurement techniques – IEMI immunity test methods for equipment and systems. Basic EMC publication.
14. IEC/TR 61000-5-3 Ed. 1.0 (1999-07): Electromagnetic compatibility (EMC) – Part 5-3: Installation and mitigation guidelines – HEMP protection concepts. Basic EMC publication.
15. IEC/TS 61000-5-4 Ed. 1.0 (1996-08): Electromagnetic compatibility (EMC) – Part 5: Installation and mitigation guidelines – Section 4: Immunity to HEMP – Specifications for protective devices against HEMP radiated disturbance. Basic EMC Publication.
16. IEC 61000-5-5 Ed. 1.0 (1996-02): Electromagnetic compatibility (EMC) – Part 5: Installation and mitigation guidelines – Section 5: Specification of protective devices for HEMP conducted disturbance. Basic EMC Publication.
17. IEC/TR 61000-5-6 Ed. 1.0 (2002-06): Electromagnetic compatibility (EMC) – Part 5-6: Installation and mitigation guidelines – Mitigation of external EM influences. Basic EMC publication.
18. IEC 61000-5-7 Ed. 1.0 (2001-01): Electromagnetic compatibility (EMC) – Part 5-7: Installation and mitigation guidelines – Degrees of protection by enclosures against electromagnetic disturbances (EM code). Basic EMC publication.
19. IEC/TS 61000-5-8 Ed. 1.0 (2009-08): Electromagnetic compatibility (EMC) – Part 5-8: Installation and mitigation guidelines – HEMP protection methods for the distributed infrastructure. Basic EMC publication.
20. IEC/TS 61000-5-9 Ed. 1.0 (2009-07): Electromagnetic compatibility (EMC) – Part 5-9: Installation and mitigation guidelines – System-level susceptibility assessments for HEMP and HPEM. Basic EMC publication.



21. IEC/TS 61000-5-10 DTS (2016-11): Electromagnetic compatibility (EMC) – Part 5-10: Installation and mitigation guidelines – Guide to the protection of facilities against HEMP and IEMI. Basic EMC publication.
22. IEC 61000-6-6 Ed. 1.0 (2003-04): Electromagnetic compatibility (EMC) – Part 6-6: Generic standards – HEMP immunity for indoor equipment. Basic EMC publication.

## References

1. MIL-STD-188-125-1, "High-Altitude Electromagnetic Pulse (HEMP) Protection For Ground-Based C4I Facilities Performing Critical, Time-Urgent Missions, Part 1: Fixed Facilities," April 7, 2005.
2. MIL-HDBK-423, "High-Altitude Electromagnetic Pulse Protection for Fixed and Transportable Ground-Based Facilities, Volume I: Fixed Facilities."
3. TM 5-690, "Grounding and Bonding in Command, Control, Communications, Computer, Intelligence, Surveillance, and Reconnaissance (C4ISR) Facilities."
4. MIL-HDBK-419, "Grounding, Bonding, and Shielding for Electronic Equipment and Facilities."
5. MIL-STD-785, "Reliability Program for Systems and Equipment Development and Production."
6. MIL-STD-470, "Maintainability Program for Systems and Equipment."
7. MIL-STD-2165, "Testability Program for Electronic Systems and Equipment."
8. MIL-STD-729, "Corrosion and Corrosion Prevention Metals."
9. IEC 61000-4-36 Ed. 1.0 (2014-11): Electromagnetic compatibility (EMC) - Part 4-36: Testing and measurement techniques – IEMI immunity test methods for equipment and systems.
10. IEEE-Std 81-2012, "Guide for Measuring Earth Resistivity, Grounding Impedance, and Earth Surface Potentials of a Ground System."
11. IEEE Std 299-2006, "Standard Method for Measuring the Effectiveness of Electromagnetic Shielding Enclosures."
12. Meta-R-319, *Geomagnetic Storms and Their Impacts on the U.S. Power Grid*, John Kappenman, Metatech Corporation, for Oak Ridge National Lab, January 2010.
13. Meta-R-320, *The Early-Time (E1) High-Altitude Electromagnetic Pulse (HEMP) and Its Impact on the U.S. Power Grid*, by Dr. Edward Savage, Dr. James Gilbert, and Dr. William Radasky, Metatech Corporation, for Oak Ridge National Lab, January 2010.
14. Meta-R-321, *The Late-Time (E3) High-Altitude Electromagnetic Pulse (HEMP) and Its Impact on the U.S. Power Grid*, by Dr. James Gilbert, Dr. Edward Savage, John Kappenman, and Dr. William Radasky, Metatech Corporation, for Oak Ridge National Lab, January 2010.
15. Meta-R-322, *Low-Frequency Protection Concepts for the Electric Power Grid: Geomagnetically Induced Current (GIC) and E3 HEMP Mitigation*, by John Kappenman, Metatech Corporation, for Oak Ridge National Lab, January 2010.

16. Meta-R-323, Intentional Electromagnetic Interference (IEMI) and Its Impact on the U.S. Power Grid, by Dr. William Radasky and Dr. Edward Savage, Metatech Corporation, for Oak Ridge National Lab, January 2010.
17. Meta-R-324, High-Frequency Protection Concepts for the Electric Power Grid, by Dr. William Radasky and Dr. Edward Savage, Metatech Corporation, for Oak Ridge National Lab, January 2010.
18. TIA-607, Revision C (2015-11), "Generic Telecommunications Bonding and Grounding (Earthing) for Customer Premises.

## APPENDIX A – EMP Protection Test and Acceptance Criteria

Table A1. Injected pulse characteristics

From Reference 1. See notes at end of Table A3.

Class of Electrical POE	Pulsed Current Injection Requirements <sup>1</sup>			
	Type of Injection	Peak Short-Ckt Current (A)	Risetime (s)	FWHM <sup>2</sup> (s)
Commercial Power Lines (Intersite)				
Short Pulse	Common mode	5,000	$\leq 2 \times 10^{-8}$	$5 \times 10^{-7} - 5.5 \times 10^{-7}$
Short Pulse	Wire-to-ground	2,500	$\leq 2 \times 10^{-8}$	$5 \times 10^{-7} - 5.5 \times 10^{-7}$
Intermediate Pulse	Common mode	250	$\leq 1.5 \times 10^{-6}$	$3 \times 10^{-3} - 5 \times 10^{-3}$
Intermediate Pulse	Wire-to-ground	250	$\leq 1.5 \times 10^{-6}$	$3 \times 10^{-3} - 5 \times 10^{-3}$
Long Pulse	Common mode	<sup>3</sup> 1,000	$\leq 0.2$	<sup>3</sup> 20–25
Long Pulse	Wire-to-ground	<sup>3</sup> 1,000	$\leq 0.2$	<sup>3</sup> 20–25
Other Power Lines (Intrasite)				
Unrestricted Lines				
Short Pulse	Common mode	5,000	$\leq 2 \times 10^{-8}$	$5 \times 10^{-7} - 5.5 \times 10^{-7}$
Short Pulse	Wire-to-ground	2,500	$\leq 2 \times 10^{-8}$	$5 \times 10^{-7} - 5.5 \times 10^{-7}$
Restricted Lines				
Short Pulse	Common mode	800	$\leq 2 \times 10^{-8}$	$5 \times 10^{-7} - 5.5 \times 10^{-7}$
Short Pulse	Wire-to-ground	<sup>4</sup> $800/\sqrt{N}$ or 500	$\leq 2 \times 10^{-8}$	$5 \times 10^{-7} - 5.5 \times 10^{-7}$
Audio/Data Lines (Intersite)				
Short Pulse	Common mode	5,000	$\leq 2 \times 10^{-8}$	$5 \times 10^{-7} - 5.5 \times 10^{-7}$
Short Pulse	Wire-to-ground	<sup>4</sup> $5,000/\sqrt{N}$ or 500	$\leq 2 \times 10^{-8}$	$5 \times 10^{-7} - 5.5 \times 10^{-7}$
Intermediate Pulse	Common mode	250	$\leq 1.5 \times 10^{-6}$	$3 \times 10^{-3} - 5 \times 10^{-3}$
Intermediate Pulse	Wire-to-ground	250	$\leq 1.5 \times 10^{-6}$	$3 \times 10^{-3} - 5 \times 10^{-3}$
Long Pulse	Common mode	<sup>3</sup> 1,000	$\leq 0.2$	<sup>3</sup> 20–25
Long Pulse	Wire-to-ground	<sup>3</sup> 1,000	$\leq 0.2$	<sup>3</sup> 20–25
Control/Signal Lines (Intrasite)				
Unrestricted Low-Voltage Lines <sup>5</sup>				
Short Pulse	Common mode	5,000	$\leq 2 \times 10^{-8}$	$5 \times 10^{-7} - 5.5 \times 10^{-7}$
Short Pulse	Wire-to-ground	<sup>4</sup> $5,000/\sqrt{N}$ or 500	$\leq 2 \times 10^{-8}$	$5 \times 10^{-7} - 5.5 \times 10^{-7}$
Unrestricted High-Voltage Lines <sup>5</sup>				
Short Pulse	Common mode	5,000	$\leq 2 \times 10^{-8}$	$5 \times 10^{-7} - 5.5 \times 10^{-7}$
Short Pulse	Wire-to-ground	<sup>4</sup> $5,000/\sqrt{N}$ or 500	$\leq 2 \times 10^{-8}$	$5 \times 10^{-7} - 5.5 \times 10^{-7}$
Restricted Lines				
Short Pulse	Common-mode	800	$\leq 2 \times 10^{-8}$	$5 \times 10^{-7} - 5.5 \times 10^{-7}$
Short Pulse	Wire-to-ground	<sup>4</sup> $800/\sqrt{N}$ or 500	$\leq 2 \times 10^{-8}$	$5 \times 10^{-7} - 5.5 \times 10^{-7}$
Conduit Shields				
Signal and Low Current Power <sup>6</sup>				
Buried <sup>7</sup>	Conduit-to-gnd	800	$\leq 2 \times 10^{-8}$	$5 \times 10^{-7} - 5.5 \times 10^{-7}$
Nonburied	Conduit-to-gnd	5,000	$\leq 2 \times 10^{-8}$	$5 \times 10^{-7} - 5.5 \times 10^{-7}$
Medium Current Power <sup>6</sup>				
Buried <sup>7</sup>	Conduit-to-gnd	800	$\leq 2 \times 10^{-8}$	$5 \times 10^{-7} - 5.5 \times 10^{-7}$
Nonburied	Conduit-to-gnd	5,000	$\leq 2 \times 10^{-8}$	$5 \times 10^{-7} - 5.5 \times 10^{-7}$
High Current Power <sup>6</sup>				
Buried <sup>7</sup>	Conduit-to-gnd	800	$\leq 2 \times 10^{-8}$	$5 \times 10^{-7} - 5.5 \times 10^{-7}$
Nonburied	Conduit-to-gnd	5,000	$\leq 2 \times 10^{-8}$	$5 \times 10^{-7} - 5.5 \times 10^{-7}$

**Table A2. Residual internal stress limits for classes of electrical POEs**

From Reference 1. See notes at end of Table A3.

Class of Electrical POE	Residual Internal Stress Limits			
	Type of Measurement	Peak Response Current (A)	Peak Rate of Rise (A/s)	Root Action (A - $\sqrt{s}$ )
Commercial Power Lines (Intersite)				
Short Pulse	Bulk current	$\leq 10$	$\leq 1 \times 10^7$	$\leq 1.6 \times 10^{-1}$
Short Pulse	Wire current	$\leq 10$	$\leq 1 \times 10^7$	$\leq 1.6 \times 10^{-1}$
Intermediate Pulse	Bulk current	No damage or performance degradation		
Intermediate Pulse	Wire current	No damage or performance degradation		
Long Pulse	Bulk current	No damage or performance degradation		
Long Pulse	Wire current	No damage or performance degradation		
Other Power Lines (Intrasite)				
Short Pulse	Bulk current	$\leq 10$	$\leq 1 \times 10^7$	$\leq 1.6 \times 10^{-1}$
Short Pulse	Wire current	$\leq 10$	$\leq 1 \times 10^7$	$\leq 1.6 \times 10^{-1}$
Audio/Data Lines (Intersite)				
Short Pulse	Bulk current	$\leq 0.1$	$\leq 1 \times 10^7$	$\leq 1.6 \times 10^{-3}$
Short Pulse	Wire current	$\leq 0.1$	$\leq 1 \times 10^7$	$\leq 1.6 \times 10^{-3}$
Intermediate Pulse	Bulk current	No damage or performance degradation		
Intermediate Pulse	Wire current	No damage or performance degradation		
Long Pulse	Bulk current	No damage or performance degradation		
Long Pulse	Wire current	No damage or performance degradation		
Control/Signal Lines (Intrasite)				
Low-Voltage Lines <sup>5</sup>				
Short Pulse	Bulk current	$\leq 0.1$	$\leq 1 \times 10^7$	$\leq 1.6 \times 10^{-3}$
Short Pulse	Wire current	$\leq 0.1$	$\leq 1 \times 10^7$	$\leq 1.6 \times 10^{-3}$
High-Voltage Lines <sup>5</sup>				
Short Pulse	Bulk current	$\leq 1.0$	$\leq 1 \times 10^7$	$\leq 1.6 \times 10^{-2}$
Short Pulse	Wire current	$\leq 1.0$	$\leq 1 \times 10^7$	$\leq 1.6 \times 10^{-2}$
Conduit Shields				
Signal and Low Current Power <sup>6</sup>				
Buried <sup>7</sup>	Bulk current	$\leq 0.1$	$\leq 1 \times 10^7$	$\leq 1.6 \times 10^{-3}$
Nonburied	Bulk current	$\leq 0.1$	$\leq 1 \times 10^7$	$\leq 1.6 \times 10^{-3}$
Medium Current Power <sup>6</sup>				
Buried <sup>7</sup>	Bulk current	$\leq 1.0$	$\leq 1 \times 10^7$	$\leq 1.6 \times 10^{-2}$
Nonburied	Bulk current	$\leq 1.0$	$\leq 1 \times 10^7$	$\leq 1.6 \times 10^{-2}$
High Current Power <sup>6</sup>				
Buried <sup>7</sup>	Bulk current	$\leq 10$	$\leq 1 \times 10^7$	$\leq 1.6 \times 10^{-1}$
Nonburied	Bulk current	$\leq 10$	$\leq 1 \times 10^7$	$\leq 1.6 \times 10^{-1}$

Table A3. Injected pulse characteristics &amp; residual internal stress limits for antenna POEs

Class of Electrical POE	Pulsed Current Injection Requirements <sup>8</sup>				
	Type of Injection	Dominant Response Frequency <sup>9</sup> (MHz)	Peak Short-Circuit Current (A)	Risetime (s)	FWHM <sup>2</sup> (s)
RF antenna line shield					
Buried <sup>7</sup>	Shield-to-gnd	Not applicable	800	$\leq 2 \times 10^{-8}$	$5 \times 10^{-7}$ – $5.5 \times 10^{-7}$
Nonburied	Shield-to-gnd	Not applicable	5,000	$\leq 2 \times 10^{-8}$	$5 \times 10^{-7}$ – $5.5 \times 10^{-7}$
RF antenna line signal conductor	Wire-to-shield	$\leq 30$	Threat-level <sup>9</sup>	$\leq 2 \times 10^{-8}$	$5 \times 10^{-7}$ – $5.5 \times 10^{-7}$
	Wire-to-shield	$> 30$	Threat-level <sup>9</sup>	$\leq 5 \times 10^{-9}$	Variable <sup>9</sup>

Class of Electrical POE	Residual Internal Stress Limits			
	Type of Measurement	Peak Response Current (A)	Peak Rate of Rise (A/s)	Root Action (A - $\sqrt{s}$ )
Receive only antenna line	Shield Current	$\leq 0.1$	$\leq 1 \times 10^7$	$\leq 1.6 \times 10^{-3}$
	Wire Current	$\leq 0.1$	No damage or performance degradation	
Transmit and receive antenna line	Shield Current	$\leq 0.1$	$\leq 1 \times 10^7$	$\leq 1.6 \times 10^{-3}$
	Wire Current	$\leq 1.0$	No damage or performance degradation	

## Notes for Tables A1, A2 and A3.

<sup>1</sup>Pulse current injection requirements are in terms of Norton equivalent sources. Short-circuit currents are double exponential waveshapes. Source impedances are  $\geq 60 \Omega$  for the short pulse,  $\geq 10 \Omega$  for the intermediate pulse, and  $\geq 5 \Omega$  for the long pulse.

<sup>2</sup>FWHM is pulse full-width at half-maximum amplitude.

<sup>3</sup>The long pulse peak short-circuit current (1,000 A) and FWHM (20-25 s) are design objectives. Any double exponential waveform with peak short-circuit current  $\geq 200$  A, risetime  $\leq 0.2$  s, and peak current x FWHM product  $\geq 2 \times 10^4$  A-s satisfies the minimum requirement.

<sup>4</sup>Whichever is larger.  $N$  is the number of penetrating conductors in the cable.

<sup>5</sup>Low-voltage control/signal lines are those with maximum operating voltage  $< 90$  V. High-voltage control/signal lines are those with maximum operating voltage  $\geq 90$  V.

<sup>6</sup>High-current power lines have maximum operating current  $> 10$  A. Medium-current power lines have maximum operating current between 1 A and 10 A. Low-current power lines have maximum operating current  $< 1$  A.

<sup>7</sup>An antenna shield is considered buried when it terminates at a buried antenna and less than 1 m (3.3 ft.) of its total length is not covered by earth or concrete fill. A conduit is considered buried when it connects two protected volumes and less than 1 m (3.3 ft.) of its total length is not covered by earth or concrete fill.

<sup>8</sup>Pulse current injection requirements are in terms of Norton equivalent sources. The short pulse generator, with a source impedance  $\geq 60 \Omega$ , is used for shield-to-ground injections and for wire-to-shield injections at dominant response frequencies  $\leq 30$  MHz. A charge line pulser, with a source impedance  $\geq 50 \Omega$ , is used for wire-to-shield injections at dominant response frequencies  $> 30$  MHz.

<sup>9</sup>The dominant response frequency (or frequencies) and threat-level peak short-circuit current are determined from extrapolated coupling measurements. The length  $l$  of the charge line of the charge line pulser is the quarter-wavelength of the dominant response frequency:  $l = 0.25 c/f$ , where  $c = 3 \times 10^8$  m/s and  $f$  is frequency in Hz.

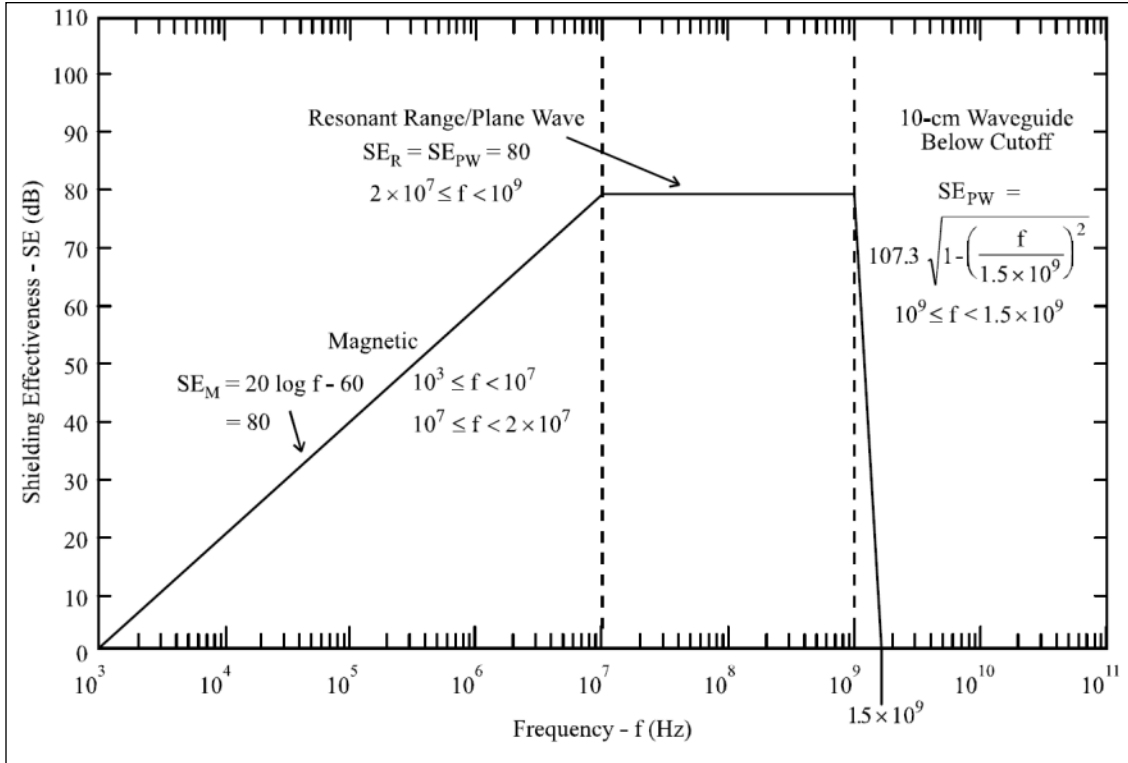

Figure A-1. HEMP Shielding Effectiveness Requirement



## APPENDIX B – EMP Protection Vendors and Services

This appendix is intended to familiarize those considering EMP protection options with the types of solutions currently available in the U.S. marketplace. The companies listed offer specialized products or services that address the threats from EMP, IEMI and GIC. This initial list is not a comprehensive source listing of companies who offer EMP related products and services. If you are a business who offers related products or services and would like to be included in future releases of this document, please contact [Kevin.Briggs@hq.dhs.gov](mailto:Kevin.Briggs@hq.dhs.gov) and include, where possible, any independent testing data that verifies product claims and customer references from previous work, if applicable.

**Disclaimer: Reference to any specific company's product or service herein does not represent an endorsement by the Department of Homeland Security (DHS) as to the effectiveness or adequacy of any product or service, nor should this Appendix be considered an approved or recommended vendor list. Use of any vendor product or service listed in this Appendix should only be done entirely based on the buyer's own analysis of alternatives and research of vendor capabilities.**

### EMP Protection Levels

Achieving cost effective protection from EM threats requires a “defense-in-depth” approach to progressively increase resiliency and ultimately harden critical systems and infrastructure. It is not necessary or financially feasible to harden all systems and infrastructure to survive and operate through an EMP event. System prioritization and planning for an EMP event should be an integral part of each organization's continuity and contingency planning efforts.

DHS EMP Protection Level 1 generally uses manual procedures to isolate off-line equipment from EM threats and adding ferrite cores to cables to attenuate unwanted HF cable signals. These are intended to be performed by existing site personnel for minimal cost. Level 2 measures focus on increasing resiliency by installing active and passive components to mitigate the conductive effects that threaten on-line systems. Level 2 measures could be performed by skilled in-house personnel or obtained through contracted services.

Levels 3 and 4 measures address the radiated effects of EM threats by installing layers of shielding around prioritized systems to harden operations. Shielding a new or existing facility is typically performed by an experienced contractor who will design, engineer, install and test the solution to meet unique site requirements and performance specifications.

## EMP Protection Level 1

Level 1 protection measures are the first line of defense in protecting essential equipment from the conductive and radiated effects of EM threats. These manual isolation procedures can protect off-line and spare equipment from initial EM effects for little to no cost. Simply disconnecting essential equipment, which can be off-line until needed, from power and telecommunications infrastructure will create physical and electrical separation and provide protection from EMP induced current. Add ferrite cores to equipment cables that must remain connected and on-line. To shield against the radiated effect of EMP, off-line equipment must be stored behind protective metal barriers. Nesting equipment behind multiple barriers has an additive effect. For example, placing emergency radios in a Faraday bag and storing them in a metal container provides more protection than the container or bag alone. Placing larger equipment in a Faraday case and storing it in a steel constructed warehouse is preferable to on-the-shelf in an office or operations building. Food, fuel and supplies should be provisioned to operate in an EMP environment up to 7 days.

### Faraday Bags

Faraday bags are the most basic type of shielding available, and are widely available online. They are primarily designed to protect small electronics such as cell phones, tablets, laptops, and handheld radios from electromagnetic interference (EMI) in the cellular, Wi-Fi and GPS bands between 700 MHz and 2.1 GHz. Bag size, construction and the level of protection can vary greatly. Nesting within multiple bags or storing the bags in a metal container to create more layers will increase the level of protection. Be aware that many bags marketed as Faraday bags are designed for evidence collection and may only provide electrostatic protection. Prices range from a few dollars for disposable bags, ~ \$200 for larger high durability bags, to a few hundred dollars for heavy duty duffel bags.

Vendors selling Faraday bags include (see [Disclaimer](#) on page 1):

**TRITECHFORENSICS** <http://tritechforensics.com/>

**Faraday Defense** <http://faradaydefense.com/>

### Faraday Containers

A Faraday container offers a more durable solution than a Faraday bag if portability is required. These rigid containers are suitable for transport or stacked storage of primary and spare equipment that can be off-line and protected until needed. Containers range in size from briefcase-sized for phones and laptops to suitcase size containers and transit cases for large components or multiple devices. Prices range from less than \$100 to a few thousand dollars. Custom engineered cases can cost between \$10K-\$40K with deployable system solutions offering onboard power, interfaces and thermal management ranging from \$40K to over \$100K.

Vendors selling Faraday containers include (see [Disclaimer](#) on page 1):

**Conductive Composites** offers a line of injection molded and laminated electronics enclosures, offered through Faraday Cases <http://faradaycases.com/> that provides shielding performance across a broad range of frequencies that meets MIL STD 461, 464 and 188-125 requirements.

**EMP Engineering** <http://empengineering.com/storage-faraday-boxes> makes a line of welded aluminum Faraday cases ranging from \$787 - \$1171 dollars.

### Ferrite Cores

Ferrite cores are widely available online and cost a few dollars. They can be clamped on, snapped on or slipped over cables near the equipment end to attenuate unwanted high-frequency cable signals. Type 61 (HF) ferrites made of Nickel Zinc are recommended. These are designed for inductive applications up to 25 MHz and attenuate interfering pulses in the 200-2000 MHz. They can be added to existing cables or purchased with ferrites pre-built in common cable types. A wholesale distributor such as **Digi-Key Electronics** (<http://www.digikey.com/product-search/en/filters/ferrite-cores-cables-and-wiring/3408554?WT.srch=1>) allows for filtering any combination of sizes and specifications to fit requirements (see [Disclaimer](#) on page 1).

Other suppliers include (see [Disclaimer](#) on page 1):

**Palomar Engineers** <http://palomar-engineers.com/ferrite-products>

**Amindon Corporation** <http://www.amidoncorp.com/61-material-ferrite-toroids/>

## EMP Protection Level 2

Level 2 adds active and passive components designed to limit the conductive effects of EMP while essential systems remain operational and connected to external power and network connections. The cost to add Level 2 measures to an existing facility is relatively low proportional to the quantity of power and communications connection that must be protected. Food, fuel and supplies should be provisioned to operate in an EMP environment for up to 7 days.

### Surge Suppressors & Filters

Many commercially available power strips have surge protection built in. These should be used to protect all essential equipment and must have a response time rating of 1 nanosecond or faster and a minimum rating of 3,000 joules and an additional let through voltage of 60 V or less to be effective for EMP types of transients. Phone line and data cable surge arresters should also be used that have a response time rating of 1 nanosecond or faster and an additional let through voltage of 60 V or less to be effective.

**APC's ProtectNet** line of surge protection devices provide protection against power transients traveling over telecommunications lines and meet rating requirements to be effective for EMP types of transients. These types of devices should be used to protect all essential equipment at each power, phone and network connection. Prices range from \$18 to \$40 dollars per device (see [Disclaimer](#) on page 1).

<http://www.apc.com/products/family/index.cfm?id=145&ISOCountryCode=us>

**ETS Lindgren** (<http://www.ets-lindgren.com/EMPHMPIEMI>) is an international manufacturer of components and systems that measure, shield and control electromagnetic and acoustic energy. Their RedEdge Technology line of EMP rated power filters (<http://www.ets-lindgren.com/EMPFilters>) is designed to MIL-STD-188-125 for both TEMPEST and non-TEMPEST applications (see [Disclaimer](#) on page 1).

**Huber+Suhner** (<http://www.hubersuhner.com/en/lightningprotection>) makes a line of EMP coaxial, data and power components. Their EMP Protector Tool Box helps you select the correct EMP devices to meet your requirements (see [Disclaimer](#) on page 1).

<http://empselector.hubersuhner.com/>

The H+S series of N-type connector inline GDT protector housings 3401.17.A and 3402.17.A, have replaceable GDT elements for different voltage levels.

H+S has a very helpful on-line calculator for finding the recommended GDT for various power levels at: <http://empselector.hubersuhner.com/gdtcalculator/index.php>. Insert your power level in watts, the DC Supply Voltage (normally zero), the maximum antenna VSWR (normally 3), and the Impedance Z (normally 50) and click on the Calculate button.

Following are some example calculations:

The calculations for 1,500 watts show that the peak voltage (with a 1.5 safety factor) will be 871 volts. The calculator selects the GDT with the lowest minimum voltage that exceeds 871 volts which is 1,020 volts for the 9071.99.0053 GDT. (Where a manufacturer specifies a nominal voltage with a 15 or 20% tolerance, the calculated tolerance voltage must be subtracted from the nominal voltage to determine the GDT's minimum voltage.)

Similarly, calculations for the following power levels are made:

- 1,000 watts has a peak voltage of 712 volts, for which the 9071.99.0052 GDT is recommended.
- 400 watts has a peak voltage of 450 volts, for which the 9071.99.0551 GDT is recommended.
- 125 watts has a peak voltage of 252 volts, for which the 9071.99.0549 GDT is recommended.

**Alpha Delta** <https://www.alphadeltacom.com/> Transi-Trap ATT3G50 coaxial surge protectors have replaceable GDT elements for different power levels. They have N female connectors on both ends (no suffix) or SO-239 UHF female connectors (U suffix). They are available for either stud mounting (no suffix) or bulkhead mounting (B suffix). One of the UHF connectors is 1.5 inches long with a UBXL suffix. The standard version of the ATT3G50 should be suitable for protecting a 125-watt transmitter, and the HP version should be suitable for protecting a 1.5 kW transmitter (see **Disclaimer** on page 1).

Alpha Delta uses GDT elements shown in Littelfuse's Gas Discharge Tube (GDT) Products catalog at <http://electronicscatalogs.littelfuse.com/app.php?RelId=6.7.0.18.4> It should be possible to better protect transmitters of other power levels by selecting different GDTs.

**PolyPhaser** has several lines of GDT type coaxial line filters that can provide EMP protection. The PolyPhaser IS-50NX-C0 (<http://www.polyphaser.com/products/rf-surge-protection/is-50nx-c0>) should protect transceivers with transmitter output powers between 500 watts and 2 kW (2.5 ns turn-on, limiting at 600 Volts) (see **Disclaimer** on p. 1).

Below 500 watts, the PolyPhaser IS-NEMP-C0 (<http://www.polyphaser.com/products/rf-surge-protection/is-nemp-c0>) has an even faster turn-on time and lower turn-on voltage (1.5 ns turn-on, limiting at 330 Volts) to provide better protection against HEMP damage.

Both of the above PolyPhaser protectors have female N connectors on both ends, but they are also available (with different part numbers) with one female and one male N connector, or with UHF connectors instead. Both of these protectors contain capacitors in series with their center pins, so they cannot pass a DC voltage (which some installations

require for powering a remote antenna tuner or switch). Both protectors contain non-replaceable GDTs.

If DC continuity through the protector is needed, the PolyPhaser 098-1013G-A (nominally limiting at 300 volts) should be good for protecting a 125-watt transmitter. Its GDT element is non-replaceable.

The PolyPhaser 103-0324A-A also provides DC continuity and uses a replaceable 3-electrode H3R7S-350H GDT element. Both chambers of this GDT are in series, which doubles its nominal 350-volt rating. The 103-0324A-A should be good for protecting a 400-watt transmitter.

Other vendors supplying EMP rated filters and suppressors include (see [Disclaimer](#), p. 1):

**Fischer Custom Communications** <http://www.fischercc.com/transient-protection-devices/>

**LCR** <http://www.lcr-inc.com/emi-rfi-filters/index.html#military>

**Captor Corporation** <http://emifilters.captorcorp.com/category/hemp-emp-filters>

**Technical Sales Solutions, LLC** <http://mytechnicalsalessolutions.com/hemp-filters/>

### **Double Conversion On-line Uninterrupted Power Supply (UPS)**

A true on-line, double-conversion type UPS is recommended for protecting equipment from EMP. Double Conversion On-Line UPS provide continuous output power from the battery backup through an inverter and not directly from the AC power source. This design provides isolation from transients on the AC power line and continual power without transfer.

Suitable UPS are available from (see [Disclaimer](#), p. 1):

**APC** <http://www.apc.com/products/family/index.cfm?id=163>

**Tripp-Lite** <http://www.tripplite.com/products/ups-systems~11>

**Cyber Power** <http://www.cyberpowersystems.com/products/tools/selector/ups>

**Emerson-Liebert** <http://www.emersonnetworkpower.com/en-US/Products/ACPower/Pages/default.aspx>

## EMP Protection Levels 3 & 4

The next two levels of protective measures involve adding protective metallic shielding to the operating environment. These solutions can range from a single equipment rack, to an operations room, to an entire building or facility at an exponential cost factor. Level 3 is designed and installed to meet commercial IEC standards. Level 4 increases the degree of protection to the higher MILSPEC-188-125 standard. Level 3 protection can be achieved with bolt-together shielded panels around all six-sides of a room or equipment rack or by relocating essential equipment into a pre-built shipping container-size shielded enclosure. Level 4 requires electrically bonded joints. All penetrations into the shielded enclosure must be bonded and grounded. Food, fuel and supplies should be provisioned to operate in an EMP environment for up to 30 days.

### Shielded Enclosures, EMP/GIC Testing, Engineering & Consulting Services

Building a shielded enclosure into a new or existing facility is the traditional proven method of EM hardening. Many companies with EMP hardening experience began and continue to support the DoD. They are very experienced in designing, engineering, installing and testing RF shielded enclosures to meet MIL-STD-188-125 applications (note: see [Disclaimer](#), p. 1). As more industries begin to address EMP threats, companies now offer solutions for commercial and civil applications with different site requirements and performance specifications the military specifications do not cover.

**Aetna Insulated Wire Company** (<http://www.aetnawire.com/pdf/SG-Brochure.pdf>) designs a series of cables known as the SafeGuardSystem that protect against E1 HEMP, IEMI, and ballistic threats including handguns, rifles and shotguns. Aetna has built and tested shielded power and signal cables that achieve a 90 dB attenuation capability and meet the residual requirements for the high-level pulse current injection testing defined in MIL-STD-188-125-1, -2 and IEC 61000-4-24 Ed. 2. These cables can be used to substitute for conduits to run critical power from a main HEMP/IEMI shielded facility to special protected volumes outside of the main shield (see [Disclaimer](#), p. 1).

**ARMAG Corporation** ([www.armagcorp.com](http://www.armagcorp.com)) Armag Corporation has a rich history of client partnership, particularly in Defense and Government, in developing and manufacturing secure facilities to provide uncompromised physical security. Armag designs and manufactures prefabricated steel, both large and small, to protect against HEMP, IEMI, GMD, and a broad spectrum of threats. Armag incorporates over forty years of experience in consultation with the client to provide solutions that meet their specific requirements. ARMAG has successfully produced and provided third party testing of facilities in order to certify RF Shielding protection in accordance with MIL-STD-188-125-2 and NSA 94-106 (see [Disclaimer](#), p. 1).



**ATEC Industries** (<http://www.atecindustries.com/>) ATEC Industries is a full-service general contractor headquartered in Elkridge, Maryland specializing in the design/build delivery of Radio Frequency (RF) shielded facilities. ATEC has the expertise to provide a turnkey solution for both new construction and renovations of varying size and scope. Since 1987 ATEC Industries has been continuously involved in the design, fabrication, construction and testing of Radio Frequency (RF) shielded facilities. ATEC specializes in Electromagnetic/Radio Frequency Interference shielding (EMI/RFI) for governmental, military and medical facilities, both as stand-alone projects and as part of larger integrated construction projects. RF attenuation requirements have varied in the magnetic and electric (H&E) fields from 50 dB at 1 kHz to 100 dB at 100 KHz to 100 dB at 50 MHz and microwave performance of 115 dB at 18 GHz to 80 dB at 50 GHz (see **Disclaimer**, p. 1).

**Braden Shielding Systems, LLC** ([www.bradenshielding.com](http://www.bradenshielding.com)) designs, manufactures, integrates and tests electromagnetic shielding systems for medical, industrial and defense applications. A core competence of the company is hardening of critical infrastructure facilities for protection against the damaging effects of electromagnetic pulse (EMP), intentional electromagnetic interference (IEMI) and geomagnetic disturbance (GMD). For more than 30 years, Braden Shielding has manufactured a comprehensive line of proven RF shielding products at its facility in Tulsa, OK. The company provides a number of high-performance shielding systems and a broad range of RF shielded facility penetrations designed specifically to address every Point of Entry (POE) to the electromagnetic shield, such as: shielded doors, power/signal/data & fiber optic filters, waveguide penetrations for mechanical, fire protection and HVAC systems, as well as custom POE's for hardness critical items outside the main shielded barrier, i.e., cooling towers, generators and telecommunications (see **Disclaimer**, p. 1).

Braden's staff of experienced design, engineering, fabrication, installation, testing and project management personnel deliver turn-key RF shielding solutions for any shielding project. The Company utilizes the latest 3-D design and Building Information Modeling (BIM) technology and offers comprehensive design support for: Hardened facility planning, architectural/structural/electrical and mechanical design integration, special protective measures and hardness maintenance/hardness surveillance.

**EMP Engineering** (<http://empengineering.com/>) is dedicated to the analysis, design, fabrication and installation of specialized shielding, components and systems to mitigate the harmful effects of Electromagnetic Pulse and Geomagnetic Storms on buildings, vehicles and structures world-wide. Their team of highly skilled professional engineers, project managers and fabricators have worked on military, government and private projects world-wide. Services include: custom evaluations, installation and commissioning services, shielding, verification testing, hardness, hardness assurance, maintenance and surveillance and EMP solutions that integrate with Architectural, Structural, Electrical, and Mechanical Engineering services to create a secured and safe shelter / bunker environment. They provide full service professional architectural, engineering solutions and products for hardened facilities including CBRE (chemical, biological, radiological,

explosive) filters, structural engineering, blast engineering and electrical/mechanical engineering are keep designed environments effective against evolving threats now and in the future. All designs and projects are HEMP hardened per MIL-STD-188-125-2. EMP Engineering also provides portable, custom designed HEMP resistant electrical generators; communications centers and data centers fabricated in ISO shipping containers at 10, 20, 30 and 40 foot lengths. These can be ballistic/blast hardened with CRBN Air-Filtration systems (see [Disclaimer](#), p. 1).

**ETS-Lindgren.** (<http://www.ets-lindgren.com/EMPHMPIEMI>). ETS-Lindgren is an innovator of systems and components for the detection, measurement and management of electromagnetic, magnetic and acoustic energy. ETS-Lindgren has the experience and expertise gained form over 70 years' experience of designing and installing more than 10,000 shielded systems worldwide. Their *RedEdge Pulse Protection* brand provides certified EMP Shielding to protect equipment and points of entry and a higher level of protection for continuous data operations with independent, uninterrupted power and utilities. Their solutions include welded steel construction, modular panel systems, doors, filters, waveguide vents and penetrations and fiber optic penetrations (see [Disclaimer](#), p. 1).

**Instant Access Networks, LLC** ([www.stop-emp.com](http://www.stop-emp.com)) is a veteran-owned Maryland based company whose on-demand services center on the protection of mission critical facilities and infrastructure from EMP primarily through its commercial-off-the-shelf products and services. IAN has produced and tested products that provide shielding from 30 dB to 140 dB, well in excess of MIL-SPEC standards and include EMP-safe inserts that fit into standard cargo containers or trailers and can come with biological/chemical/radiological air filter systems making an all-hazards safe system. IAN also developed and tested EMP-protected solar arrays, wind turbines and diesel turbines. IAN is working with over 40 companies in its DTRA SBIR contract to provide EMP protected microgrids and communications systems and welcomes additional collaborators (see [Disclaimer](#), p. 1).

**Jaxon** (<http://jaxon-em.com/>) Jaxon is one of the leading High Altitude Electromagnetic Pulse (HEMP) specialty engineering firms in the country. Jaxon is a woman owned, small business located in Colorado Springs, CO. As a faith based organization, Jaxon was created for the purpose of providing the nation with the next generation of exceptional engineering and maintenance program support for specialized and classified government sponsored tasks. In a few short years Jaxon has now grown to be one of the largest and most highly sought after Electromagnetic (EM) design, development, test and evaluation (DDT&E) firms in the US, the UK, Germany, the South Pacific, and Israel (see [Disclaimer](#), p. 1).

Jaxon specializes in all things HEMP. Since their start-up nearly seven years ago Jaxon has helped build, install, construct, test and maintain the HEMP hardening of some of the most classified and mission critical EMP hardened communication and missile warning facilities and systems around the world. Jaxon has developed multiple suites of transportable test equipment to verify equipment performance against MIL-STD-188-125 requirements.

At the present, Jaxon is working with key national leaders in the private and political sector(s), along with partners from the HEMP and Power industries and their suppliers, to transition the technology from 30-40 years of lessons learned in the Department of Defense to our nation's commercial sector. Both Micro-Grid & Macro-Grid solutions are being evaluated to accelerate progress associated with national power grid hardening and alternatives. In that regard, Jaxon management serves on the FBI's InfraGard EMP Special Interest Group as one of their Subject Matter Experts.

Jaxon personnel are presently building (testing and maintaining) hardened structures both large and small. The largest has been the MEB-1 facility located at Missile Field #1 at Ft. Greely, AK. The smallest are units used for HEMP hardened faraday cages for VFDs, various electrical panels, and residential generators. At the present time Jaxon engineers are building various forms of these "generators in a can" for survivable micro-grid power; and they are developing E1-E2 protection devices to further protect electronics and electrical appliances for residential and commercial equipment. The prototypes of these devices were first used to provide HEMP protection at a private residence. The next application will be used to protect critical medical equipment and operational capability within hospitals and other critical locations.

**L-3 Advanced Technology, Inc.** (L-3 ATI) (formerly JAYCOR Colorado Springs and JAYCOR New Mexico Shielding Technologies (NMST)) ([http://www2.l-3.com.com/ati/solutions/critical\\_infrastructure\\_shielding.htm](http://www2.l-3.com.com/ati/solutions/critical_infrastructure_shielding.htm)) supplies HEMP products, supplies and services and has the only dedicated HEMP manufacturing facility in the world, a 75,000 sq. ft. manufacturing plant in Albuquerque, NM. The plant has two large overhead five-ton cranes with runs of 275 and 175 feet respectively. The plant is complete with machine shops, blast and paint booths, five one-ton jib cranes, testing areas and specialized assembly fixtures for various MIL-STD-188-125 penetration protection devices. The HEMP line of business consists primarily of the old JAYCOR - Colorado Springs and JAYCOR - NMST shops (see **Disclaimer**, p. 1).

JAYCOR - Colorado Springs was formed in 1975 to perform nuclear weapon effects survivability hardening and testing. The JAYCOR EME division formed by Mike Bell in Colorado Springs in 1977 became the pre-eminent underground nuclear test organization. JAYCOR - Colorado Springs worked on many major weapon system EMP hardening programs (Minuteman, Peacekeeper, B-52, B-1, B-2, Polaris, Trident, M-1 Abrams, AH-64). JAYCOR EME began hardening and testing to MIL-STD-188-125 requirements in 1999 for Air Force Space Command. To date they have performed over 500+ Appendix A SE, 150 Appendix B PCI and 100 Appendix C CWI test sequences in the last seven years. No other contractor or government agency is as experienced. These test have been performed on over 400 test objects ranging from facilities buried in mountains to small shielded rooms buried in large building to small telecommunications cabinets, from small mobile systems to 12 story fixed radar sites. They have MIL-STD-188-125 tested for AFSPC, NORTHCOM, STRATCOM, ACC, GMD, NMCC, DTRA, PM DCATS, DISA, Bechtel, Harris, and Boeing.

Shield Rite was formed in 1987 by Dr. Dave Merewether as a manufacturer of high quality RF doors and RF shielding. The Shield Rite door is a patented design installed in over 360 locations worldwide and recognized as the most robust RF door on the market. Over the past 38 years, the main business has been the fabrication of extremely robust, HEMP Shielded doors then expanding to provide custom designed hardened shelters and facilities. Shield Rite was purchased by JAYCOR in mid - 2002 along with all manufacturing rights, patents for various Shield Rite technologies. A new manufacturing / fabrication facility was established in Albuquerque, New Mexico. JAYCOR was purchased by Titan, Inc. in late 2002. Titan was purchased by L-3 Communications in August 2005.

**Metatech Corporation** (<http://www.metatechcorp.com/>) is a small veteran-owned and operated business of highly-qualified scientists and engineers with broad experience (many employees with 30 - 40 years of experience) in developing technically sound and innovative solutions to problems in all areas of electromagnetic environmental effects, including: electromagnetic interference and compatibility (EMI/EMC), geomagnetic storm assessments and protection, nuclear electromagnetic pulse prediction, assessments, protection and standardization (e.g. HEMP and SREMP), and intentional electromagnetic interference (IEMI) assessments, protection and standardization (see [Disclaimer](#), p. 1).

Metatech is a key contributor to EMP research in the areas of High-altitude and Source Region EMP environments and coupling and in the development of hardening and testing technologies including military standards, specifications, and handbooks. Major programs include SREMP testing and analyses at flash x-ray simulators, SREMP and HEMP standards development, HEMP environment and long-line coupling calculations and direct support for the design of facilities to achieve HEMP hardening. Their IEMI activities have involved performing assessments of facilities, performing tests to determine the IEMI susceptibility of equipment and designing protection for the high-frequency portions of HEMP and IEMI together. In 2010 Metatech evaluated the threat of IEMI to the U.S. power grid for FERC and published its work in Meta-R-323, which is found at: [http://web.ornl.gov/sci/ees/etsd/pes/ferc\\_emp\\_gic.shtml](http://web.ornl.gov/sci/ees/etsd/pes/ferc_emp_gic.shtml) (site under reconstruction)

**Noovis** ([www.noovis.com](http://www.noovis.com)) provides critical communication and IT-based infrastructures which have core advantages from those currently deployed ranging from EMP resilience to reduced energy consumption and expediting post-event recovery (see [Disclaimer](#), p. 1).

Noovis designs, installs and integrates core IT infrastructures using passive optical networking that drastically reduces copper connectivity and its associated power requirements within communication and Information systems. The Noovis passive, fiber-rich designs and infrastructures are intrinsically more resistant to EMP and HPM attacks, thus complimenting existing risk mitigation strategies and disaster recovery plans. This is accomplished, in part, as the Noovis network topology effectively eliminates the need for access switches, within a Local Area Network (LAN) and provides an entirely passive and encrypted optical pathway for data to support communication networks, typical end user devices as well as critical Industrial Control Systems (ICS), Supervisory Controls and Data

Acquisition (SCADA) networks. Noovis designed networks can run miles without the insertion of electronics versus the requirement for electronics approximately every 300 feet for current networks. In addition, this creates substantially reduced power consumption over traditional network connectivity, decreasing the draw on micro-grid generated power, allowing the reallocated energy to be used for additional critical needs. More pragmatically, Noovis designed networks meaningfully reduce CapEx and OpEx requirements, when compared to current networks, while improving bandwidth, resilience and sustainability.

**NVIS Communications** ([www.nviscom.com](http://www.nviscom.com)) and its systems integration partner Pepro LLC (<http://www.peprollc.com/>) designs and manufactures shielded enclosures using a patented Faraday Cage technology to protect sensitive communications equipment against lightning strikes, Electromagnetic Pulses (EMP), Electromagnetic Interference (EMI), Passive Intermodulation (PMI), and Radio Frequency Interference (RFI). Over the life of the company, our clients have enjoyed the security of knowing that no piece of their mission critical equipment housed in our shelters is at risk of loss due to any of these threats. Our equipment has endured many thousands of amps/joules in very rigorous industry standard testing criteria and always performed flawlessly. The NVIS/Pepro team operates efficiently and effectively to meet our customer's needs through communication before, during, and after the manufacturing process. Each of our standard products has the ability to be customized in order to best address a variety of potential applications and needs. These needs range from remote difficult to reach fixed site to small/medium and very large deployable mobile platforms all the way to very compact rapid deployable (C130/C17 transportable) kits. Our commitment to excellence includes on-time delivery and ongoing support for all of our products, as well as the strongest warranty in the Industry. We provide the confidence necessary to know that a critical communication system will be there when needed. (see [Disclaimer](#), p. 1).

**Scientific Applications & Research Associates (SARA), Incorporated** (<http://www.sara.com/emp.html>) was formed in 1989 to harness the creativity, innovation and entrepreneur spirit of engineers and scientists. SARA, Inc. is employee-owned and is managed by leaders that each has 20-30 years of experience in Defense and Aerospace. SARA is nearly 100 innovative scientists and engineers doing research and development for government, military, and industrial clients. SARA has world-class expertise in understanding, modeling, fabricating, testing and adapting high power EM (EMP and HPM) transmission, propagation, detection, diagnosing and shielding/hardening and low signal level EM and RF sensing and signal processing, including passive EM detecting. Their "Cradle to Grave Hardening" offers architectural and engineering services for EMP subsystem/electrical subsystem integration, hardness maintenance & surveillance, EMI/EMP modeling, testing and analysis and power quality and reliability of EMP related components (see [Disclaimer](#), p. 1).

**Storm Analysis Consultants** (<http://solarstormconsultant.com/>) provides consulting and information on severe solar storms, space weather, geomagnetic storms and the electrical power grid impacts. Principal Consultant John Kappenman has been a one of the leading advisors for power companies both nationally and globally on the effect of solar storms to utilities. Storm Analysis Consultants analysis services include: Assessing the Space Weather Threat Environment, Assessing Impact on Critical Infrastructures & Systems with PowerCast™, Geomagnetic Storm NowCasting and Forecasting Technology...Tailored to the Electrical Power Industry, Simulate Historic and Probable Threat Scenarios, Model Complex Geologies for accurate GIC Calculation, Scalability of PowerCast to Model Large Geographic Regions and Multiple Interconnected Power Grids, Assessing Space Weather Threat Environment Over Broad Ocean Regions and modeling Geo-potentials on cross undersea cables (see **Disclaimer**, p. 1).

**Michael A. Caruso**, ([carusomi54@gmail.com](mailto:carusomi54@gmail.com), 847-226-8849) is an independent consultant based in the Western Chicago, Illinois suburbs offering consulting services for TEMPEST, SCIF, and EMP protected facility design. Mr. Caruso has been involved in the business working with both Government and private clients for over 33 years and offers an independent perspective of risk evaluations, various mitigation techniques and available vendor materials (see **Disclaimer**, p. 1).

**Triton Metals Inc** (<http://www.tritonmetals.com/>) is one of the largest metal manufacturers on the East Coast. Together with Electromagnetic Associates, LLC ([www.emag-associates.com](http://www.emag-associates.com)) they provide EM threat hardening, design and integration, as well as EM threat project management and construction administration/construction management services of critical infrastructure systems and life-safety systems that must work during and after a HEMP/EMP attack, such as power systems, controls, data centers, CBRN air-filtration systems, water systems, communications systems and sensor systems (see **Disclaimer**, p. 1).

**Trusted Systems** (<http://www.trustedsys.com/>) is the pioneer and industry leader in the development and deployment of the Information Processing System Security Container or SCIF in a Box® which combines the physical strength against near blast protection and magnetic shielding of a GSA Class 5 IPS Container with EMP shielding exceeding MIL-STD-188-125. Their product line offers sizes and configurations from COOP sites, to remote critical infrastructure facilities to office and large data centers (see **Disclaimer**, p. 1).

**Page Southerland Page, Inc. (Page)** (<http://pagethink.com/v/iemi-hemp-protection/>) a 450-plus-person architecture and engineering firm working in the U.S. and abroad, offering specialty design and engineering services for Critical Infrastructure facilities. Services include planning, programming, design, commissioning and construction administration for facilities protected from HEMP, IEMI, GMD and other high- and low-frequency electromagnetic radiation. Page offers complete solutions, drawing upon experience protecting buildings and campuses owned by government, public utilities, universities, healthcare, research, petrochemical, and manufacturing companies from



many types of threats: explosion, espionage, terrorism, floods and hurricanes. Page has extensive experience with electromagnetic shielding for network operations centers, embassies, data centers, and medical and biotechnology research facilities. Page can manage a critical design project from program concept to completion of construction, working with experienced partners to ensure that shielded facilities perform as designed. Page's recent portfolio includes two large (>70,000 SF), privately-owned HEMP & IEMI-shielded SCADA control and data centers, each serving markets of over 2 million customers (see [Disclaimer](#), p. 1).

## Shielded Data Centers

If a hosted solution is an option for data storage, particularly for a disaster recovery environment, two companies are known to offer data center services within their EM hardened data centers.

**Cyber Innovation Labs (CIL)** (<http://www.cyberinnovationlabs.com/>) is a premier provider of enterprise-class managed Infrastructure-as-a-Service solutions and professional services. CIL's Protected Platform as a Service (PPaaS) can provide EMP, HEMP, and IEMI shielded colocation and 100% private, single-tenant cloud solutions for delivery of mission critical applications and services to customers, at price points on par with less robust traditional offerings. CIL offers custom designed steel wall, slab-to-roof facility shell, installed with 360 degree EMP shielded protective hardened enclosure. Customer facilities include all shielding, housing, filtering and/ or hardening for all electrical, mechanical and related MEP/FP infrastructure and related subsystems. All facilities are designed, installed and tested per MIL-STD-188-125-1/2 standards (see [Disclaimer](#), p. 1).

**EMP Grid Services LLC**, (<http://www.empgridservices.com/>) a CIL venture, is a consortium of industry-leading advanced engineering and data-center centric design/build specialists experienced in the data center build, commission and delivery of EMP, HEMP, IEMI and Geomagnetic Storm Protected facilities. Built from the ground up and backed with enhanced (2N) Tier 3 standards and onsite per generation capabilities in excess of 30 days, EMP GRID Services solutions provide ultra-resilient infrastructures to clients whose mission-critical systems require survivability from catastrophic events that may impact local, regional & potentially national failure of the electrical power grid (see [Disclaimer](#), p. 1).

## Transformers and Generators

**Advanced Fusion Systems, LLC (AFS)**, (203-270-9700), has a substantial portion of its activities at their Newton CT manufacturing and test facility devoted to the manufacturing of patented protective devices and systems, source generation systems for EMP and solar storm simulation (GIC), and shielded test facilities (see [Disclaimer](#), p. 1).



*EMP and GIC Protective Devices and Systems:* All AFS devices and systems are based on patented electron tube technology which offers rise times below 100 picoseconds coupled with single device capability to 1.2 MV and currents to hundreds of kA simultaneously. These tubes are built to specific customer specifications and tailored to the application area where they are to be used. Specific variants for generators, through-shielded wall and bus bar installation applications and integrated systems for protection of sub-station class transformers which provide both EMP and GIC protection are available.

*EMP and GIC Source Generation Systems:* AFS has unique electromagnetic source generation capabilities. Based on our electron tube technologies, AFS is able to build EMP sources which do not require a Marx generator. Instead, AFS uses its electron tubes in a configuration reminiscent of electronic warfare techniques to generate its pulses. The system uses Arbitrary Waveform Generation to create any stored waveform. This is vastly different from Marx Generator based systems whose ability to tailor waveforms is extremely limited. The AFS facility can also generate very long time duration pseudo-DC waveforms also using the Arbitrary Waveform Generation technique. This enables the lab to duplicate specific solar storm events. The instrumentation is rated at 20 GHz and the oscilloscopes resolve 17 picosecond single shot pulses on 8 channels.

*Shielded Test Cells:* AFS's Electromagnetics Test Facility is unique in the US and world and has been purpose built. AFS currently has one 80 foot long, 40 foot wide, 20 foot high fully shielded Test Cell which meets or exceeds the requirements of MIL 188-125. This test cell has a full scale 3 phase 150 KV transmission line for testing protective devices and systems. The transformers have the Wye connection brought out through a fully rated bushing which enables introduction of DC or pseudo-DC waveforms into the transformer. The transformers will be tested to destruction during the qualifying and calibration tests. The Test Cell is rated and will produce EMP waveforms to 250,000 Volts/meter, making it probably the highest field test cell in the country. The Test Cell also incorporates the ability to duplicate the magnetic field conditions of multi-gigawatt transmission lines. The cell has (16) fiber optic temperature sensors in the transformers (2), and (18) 20 GHz instrumentation channels. The Test Cell has a 16 foot by 16 foot shielded door.

AFS allows certain qualified external users to rent this facility and staff for testing purposes, recognizing its unique capabilities and the corporate philosophy of wanting to support all activities which increase the electromagnetic hardness of the US power grid.

**Emprimus** ([www.emprimus.com](http://www.emprimus.com)) develops and produces product that defeat the effects of Geomagnetically Induced Currents and Electromagnetic Interference caused by Solar Flares, RF Weapons and Nuclear EMP. Their two primary EMP related products include a system to protect High Voltage (HV) and Extra High Voltage (EHV) class power transformers and an electromagnetic threat detection system. The Emprimus SolidGround™ Neutral DC Blocking System automatically blocks DC currents from flowing in the neutral of large power transformers to protect against GIC and EMP E3 induced currents. The RF-71 Inferential Detector™ provides real-time identification of IEMI/EMP incidents, provides

critical forensic information and can be integrated into systems dashboards to enable appropriate security and disaster team response. Emprimus also offers services for measurement, assessment, design, implementation and test remediation to protect critical systems and assets against IEMI, EMP and geomagnetic storms (see [Disclaimer](#), p. 1).

## New Approaches to EMP Protection

Hardening a new facility with welded steel can be cost prohibitive. Retrofitting an existing facility adds operational disruption to the complexity and cost of a major renovation project. Depending on your site specific mission and requirements, this may remain the best approach. However, two alternative solutions are coming to market to address EM threats for civil and commercial applications which may be more cost effective and less disruptive to current operations.

**1. Conductive Composites** (<http://www.conductivecomposites.com/>) has developed and commercialized a line of multifunctional electrically conductive and electromagnetic shielding materials. They provide cost effective performance across a broad spectrum of electromagnetic threats for numerous types of shielding applications. They offer multifunctional structural materials that integrate directly into typical manufacturing architectures, in addition to installation, test, and certification services. Shielding of Critical Facilities can be achieved using a family of solutions that include conductive wallpapers, paints, adhesives, stuccos, concretes, and window screens. Facilities shielded with these materials have been shown to effectively attenuate EMI/RFI as well as shield against EMP threats. A key differentiating feature is that the materials can be easily retrofitted into existing facilities as well as new construction. Conductive Composites is considered critical to the defense industrial base, with rated production contracts and classified programs, and has been awarded numerous funding phases from the Defense Production Act (DPA) Title III program. (see [Disclaimer](#), p. 1).

**2. American Business Continuity Group, LLC** (<http://www.americanbcg.com/emp>) constructs conductive concrete structures for multi-threat protection from High Altitude Electromagnetic Pulse (HEMP), Intentional Electromagnetic Interference (IEMI), compromising emanations, terrorist ballistic/blast attacks and extreme natural disasters. ABC Group's proprietary construction methodologies have been deployed to build steel-reinforced concrete structures that are threat configurable, scalable, energy efficient and cost effective. The company recently completed the world's first building code compliant electromagnetic shielded shotcrete structure at its disaster recovery complex in Lakeland, FL. The building exceeds shielding requirements of MIL-STD-188-125. Concurrently ABC Group has engineered and built a 14,000 square foot open span structure, confirming the scalable design and engineering for our electromagnetic shielded structures. The group is currently constructing the Vertical Electro-Magnetic Pulse Simulator (VEMPS) at Patuxent River Naval Air Station, Patuxent River, Maryland. (see [Disclaimer](#), p. 1).

The ABC Group has three decades of success as a high integrity industrial GC, a decade of success with specialized design-build hardened structures and experience in the nuclear power industry, building Fukushima Flex/Beyond Design Basis structures that meet NRC Regulatory Guide 1.76 standards. Building on a history of success, the company now constructs EMP - IEMI shielded structures that also incorporates protection from ballistic /blast, natural threats, including Cat 5 hurricanes, EF-5 tornados, and seismic events.

## APPENDIX C – Priority Service and Restoration Programs

The Department of Homeland Security (DHS) Office of Emergency Communications (OEC) offers priority services programs to mitigate the impacts of communications threats such as EMP and to enhance the ability of our critical national security and emergency preparedness personnel to communicate during disasters. In addition, the DHS National Coordinating Center for Communications (NCC) provides resilient backup communications services through the SHARES program.

### Priority Telecommunications Services

OEC provides priority telecommunications services to support national security and emergency preparedness communications for government officials, emergency responders, critical infrastructure personnel, and industry members. The Government Emergency Telecommunications Service (GETS), Wireless Priority Service (WPS), and Telecommunications Service Priority (TSP) programs ensure key Federal, State, local, Territorial and Tribal governments, and first responder and industry organizations have communications capabilities available to support emergency response incidents.

GETS provides priority access on the landline networks:

- Increases call completion during telephone network congestion
- Does not require special phone equipment
- No charge for test calls or enrollment
- Priority access, including calls to most cellular devices

WPS provides priority access on the wireless networks:

- Increases call completion on cell phones during network congestion
- Is an add-on feature to your cell phone
- Can be used in conjunction with GETS to provide priority access

TSP provides priority installation and repair of critical communications circuits:

- Federal Communications Commission (FCC) mandated program to prioritize restoration and installation of circuits
- Vendors restore or install TSP circuits prior to servicing other non-TSP circuits
- Covers voice and data circuits that support emergency operations

## Government Emergency Telecommunications Service (GETS)

During emergencies, the public telephone network can experience congestion due to increased call volumes and/or damage to communications infrastructure, hindering the ability of critical personnel to complete their calls. GETS is accessible nationwide providing authorized personnel priority access and processing during an emergency or crisis situation when the landline networks are congested and the probability of completing a call is reduced. GETS facilitated response and recovery efforts during and after events such as 9/11 and Hurricanes Katrina, Ike, and Sandy by providing over a 95 percent call completion rate.

GETS is an easy-to-use calling card service that works on both local and long distance networks; no special phones are required. Calls placed through GETS will receive priority over normal calls; however, GETS calls do not preempt calls in progress or prevent the general public's use of the telephone network. GETS allows users to communicate even during the highest levels of network congestion and also provides priority calling to cell phones during times of congestion on most major carrier networks. There is no charge to enroll in GETS or to make calls to the familiarization line. When making GETS calls, subscribers can be charged the equivalent of long distance phone rates.

## Wireless Priority Service (WPS)

During emergencies, cellular networks can also become congested, hindering the ability of national security and emergency preparedness personnel to complete emergency calls on their cell phones. The WPS program is available nationwide, and is intended to provide authorized personnel priority access in an emergency or crisis situation when the cellular networks are congested and the probability of completing a call is reduced. After the April 2013 bombing at the Boston Marathon, up to 93 percent of calls placed through WPS were successfully completed, allowing critical personnel to carry out their missions to assist the public.

WPS is an easy-to-use, add-on feature that is offered by all nationwide cellular service providers. Authorized personnel can subscribe to WPS on a per-cell phone basis. Calls placed via WPS will receive priority over normal cellular calls; however, WPS calls do not preempt calls in progress or prevent the general public's use of the cellular networks. WPS subscribers are responsible for any cellular carrier charges for initial enrollment and monthly subscription, as well as per-minute usage fees.

## Telecommunications Service Priority (TSP)

Following hurricanes, floods, earthquakes, and other natural or man-made disasters, telecommunications service vendors can experience a surge in requests to restore existing services and/or install new services. TSP authorizes qualifying organizations to receive priority installation and restoration of vital voice and data circuits or other

telecommunications services supporting national security and emergency preparedness operations. A FCC mandate ensures that service vendors will prioritize the installation and/or restoration of critical circuits and services with TSP assignments before any non-TSP request.

An organization can only receive a TSP assignment if it maintains services or infrastructures that are considered critical national security and emergency preparedness communications assets. TSP subscribers are subject to minimal telecommunications carrier charges for initial enrollment and monthly subscription fees.

In the aftermath of Hurricane Sandy, TSP was critical to restoration and recovery efforts by facilitating the rapid repair of damaged circuits and processing over 200 requests to install new circuits for the response community.

### **TSP Eligibility Criteria**

The national security and emergency preparedness community spans the Federal, State, local, Tribal and Territorial governments, public safety and emergency responders, industry partners who are responsible for maintaining the Nation's critical infrastructure, and other authorized users. Organizations that rely on telecommunications on a daily basis to provide public health, maintain law and order, ensure public safety, or provide financial or utility service should enroll in these vital priority services.

Typical GETS, WPS, and TSP users are responsible for the command and control functions critical to management of, and response to, national security and emergencies.

Five broad categories serve as criteria for determining eligibility for the priority telecommunications services. Users typically perform functions that:

- Serve national security leadership;
- Support the national security posture and U.S. population attack warning systems;
- Support public health, safety, and maintenance of law and order activities;
- Maintain the public welfare and the national economic system; or
- Are critical to the protection of life and property or to national security and emergency preparedness and disaster recovery activities during an emergency.

### **TSP Enrollment Process**

The first step in the enrollment process is to establish a point of contact (POC) for your organization. Many organizations already have established POCs who facilitate the enrollment process. To determine the POC and enroll in the priority services programs, please contact the **DHS Priority Telecommunications Service Center at (866) 627-2255**, or visit one of the following websites: [www.dhs.gov/GETS](http://www.dhs.gov/GETS), [www.dhs.gov/WPS](http://www.dhs.gov/WPS), or [www.dhs.gov/TSP](http://www.dhs.gov/TSP).

## SHARES Program

National security and emergency preparedness (NS/EP) personnel need to transmit critical messages to coordinate emergency operations even when traditional means of communicating via landlines and cellphones are damaged or destroyed. The SHARed RESources (SHARES) Program, administered by the Department of Homeland Security's (DHS) National Coordinating Center for Communications (NCC), provides an additional means for users with a NS/EP mission to communicate when landline and cellular communications are unavailable.

SHARES members use existing HF radio and other communications resources of government, critical infrastructure, and disaster response organizations to coordinate and transmit **emergency** messages. SHARES users typically rely on HF radio and satellite communications to perform critical functions, including those areas related to leadership, safety, maintenance of law and order, finance, and public health. This program also provides the emergency response community with a single interagency emergency message handling and frequency sharing system. SHARES promotes interoperability between HF radio systems and promotes awareness of applicable regulatory, procedural, and technical issues.

More than 2,100 HF radio stations—representing 104 federal, state, and industry organizations located in all 50 states, the District of Columbia, and several locations overseas—are resource contributors to the SHARES HF Radio Program. Nearly 500 emergency planning and response personnel participate in SHARES. Approximately 180 HF radio channels are available for use by SHARES members.

Membership in the SHARES program by government (federal, state, and county), critical infrastructure, and disaster response organizations is voluntary. SHARES is available on a 24-hour basis and requires no prior coordination or activation to transmit messages. Members consult the *SHARES Handbook* to find stations, frequencies and/or Automatic Link Establishment (ALE) addresses of participating organizations they need to communicate/coordinate with. Participating SHARES HF radio stations accept and relay messages until a receiving station is able to deliver the message to the intended recipient.

Further information on SHARES may also be obtained at <https://www.dhs.gov/shares> or by contacting the SHARES Program Office at 703-235-5329 or [nccshares@dhs.gov](mailto:nccshares@dhs.gov).

**UNCLASSIFIED**

---

# **Electromagnetic Pulse (EMP) Protection and Restoration Guidelines for Equipment and Facilities**

Appendix D – Background on EMP

---



December 22<sup>th</sup>, 2016

Version 1.0

Developed by the  
National Coordinating Center for Communications (NCC)  
National Cybersecurity & Communications Integration Center (NCCIC)  
Arlington, Virginia

**UNCLASSIFIED**



## APPENDIX D – Background on EMP

The following briefing slides provide some background information on the various types of EMP and then focus on SREMP, HEMP and IEMI. For additional detailed information on SREMP and HEMP as well as related threats such as geomagnetic storms and radio frequency weapons (that is, IEMI weapons), the following Metatech Corporation reports prepared in January 2010 for Oak Ridge National Laboratory are recommended.

- Meta-R-319: Geomagnetic Storms and Their Impacts on the U.S. Power Grid by John Kappenman, Metatech Corporation, January 2010.
- Meta-R-320: The Early-Time (E1) High-Altitude Electromagnetic Pulse (HEMP) and Its Impact on the U.S. Power Grid, by Dr. Edward Savage, Dr. James Gilbert, and Dr. William Radasky, Metatech Corporation, January 2010.
- Meta-R-321: The Late-Time (E3) High-Altitude Electromagnetic Pulse (HEMP) and Its Impact on the U.S. Power Grid, by Dr. James Gilbert, John Kappenman, Dr. William Radasky, and Dr. Edward Savage, Metatech Corporation, January 2010.
- Meta-R-322: Low-Frequency Protection Concepts for the Electric Power Grid: Geomagnetically Induced Current (GIC) and E3 HEMP Mitigation, by John Kappenman, Metatech Corporation, January 2010.
- Meta-R-323: Intentional Electromagnetic Interference (IEMI) and Its Impact on the U.S. Power Grid, by Dr. William Radasky and Dr. Edward Savage, Metatech Corporation, January 2010.
- Meta-R-324: High-Frequency Protection Concepts for the Electric Power Grid by Dr. William Radasky and Dr. Edward Savage, Metatech Corporation, January 2010.



## Background: What is EMP?

**Significant electromagnetic pulse (EMP) threats occur when:**

1. A nuclear weapon is detonated
2. An extreme solar storm occurs
3. A non-nuclear EMP (Radio Frequency) weapon is used

**Three major types of nuclear EMP**

1. Source Region EMP (SREMP) - observed since our first nuclear test
  - Mainly a problem with surface detonations
  - Can disrupt power and communications throughout an entire city/region
  - Physics are well understood/modeled, but effects are widely misunderstood
2. High Altitude EMP (HEMP) – from balloon or missile nuclear burst
  - 1 burst can disrupt U.S. power/communications over many states or continent
  - May take months or years to repair damage
  - Controversy over strength of electric fields
3. System Generated EMP (SGEMP)
  - Disrupts/damages satellites

UNCLASSIFIED



## Source Region EMP Generation/Effects

The “source region” for a surface burst is typically 2 – 5 km if burst outside. It is the region where the initial radiation output (gamma, x-rays, neutrons) produces electron currents and air conductivity -- the sources for the SREMP

**However, SREMP can disrupt systems over 100 miles away**

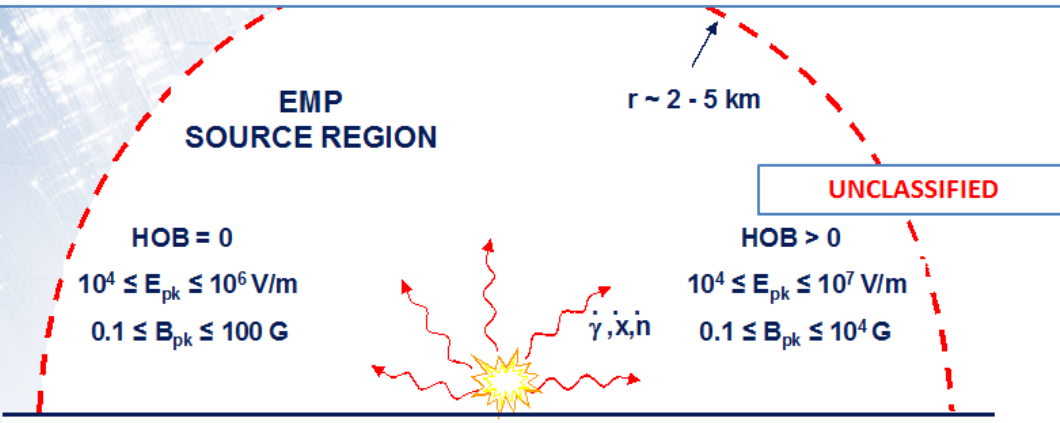

**EMP SOURCE REGION**

HOB = 0

$10^4 \leq E_{pk} \leq 10^6 \text{ V/m}$

$0.1 \leq B_{pk} \leq 100 \text{ G}$

$r \sim 2 - 5 \text{ km}$

$\gamma, x, n$

HOB > 0

$10^4 \leq E_{pk} \leq 10^7 \text{ V/m}$

$0.1 \leq B_{pk} \leq 10^4 \text{ G}$

UNCLASSIFIED



## Source Region EMP – Why worry?

- **1945: Enrico Fermi predicted Source Region EMP with the first nuclear detonation at ground level (Trinity Test)**
  - Even with shielding, some test equipment failed and records were lost
- **During 1950s/60s surface burst tests, equipment/cables were damaged by SREMP in over 100 cases at the Nevada Test Site**
  - Cables & connected equipment were damaged in almost every test
  - Circuit breakers tripped at Mercury (30 miles away) — needed reset
- **In a 1953 test, a cable bundle was damaged at the Control Point (13 miles away) -- wires were melted**
- **A fire was started during SREMP testing of President's comms**
- **Electronics can be upset/damaged over 100 miles from burst**
- **SREMP can cause long-term regional power outages**
- **SREMP can damage electronics in deeply buried structures**

UNCLASSIFIED



## SREMP Line Coupling

- **For short lines, such as Cat 5 Ethernet cables, SREMP can cause damage to connected equipment for distances far beyond the blast damage region**
- **For long (> 2 km) power and communications lines the SREMP fields at times of 1 ms and later couple very efficiently whether the line is above ground or buried**
- **For power lines, the line resistance is very low (especially for high voltage lines) and the voltages and currents propagate efficiently outside of the source region**
- **For telecom lines, the line/conduit resistances per unit length are much higher reducing the propagating SREMP, but the levels of voltages and currents that are damaging to equipment are much lower than for power lines**

UNCLASSIFIED





### Calculated SREMP Line Coupling Damage/Upset for Various Yields

Yield (kT)	1	10	100	1000
	<---- range to effect in km ---->			
Destruction of most commercial buildings	0.47	1.00	2.16	4.65
Moderate damage to commercial buildings	1.42	3.07	6.61	14.2
Buried Telecommunications Cable Damage	13.00	21.00	34.91	44.16
Radial Overhead HV Powerline Damage	35.00	65.00	110.05	134.16
0.5 km Offset Overhead HV Powerline Upset	0.30	43.00	66.00	84.00
100' Ethernet Cable Damage	11.34	21.04	23.76	26.40
100' Ethernet Cable Upset	41.11	77.42	86.88	95.84
Wireline Telephone Damage	32.78	69.19	77.16	87.90
Cordless Telephone Damage	57.21	118.50	131.80	149.64
1000' T1 Communications Line Damage	46.18	95.26	105.84	115.06
1000' T1 Communications Line Upset	79.91	161.84	179.35	194.57
200' Cell Tower Shield Upset	5.95	14.36	15.33	16.25
100m FM Tower Shield Upset	17.30	38.95	42.38	44.60
500m FM Tower Shield Upset	64.28	133.38	160.37	180.06
600m DTV Tower Shield Upset	82.92	183.31	226.00	256.48
200m AM Antenna Signal Upset	35.08	78.97	90.18	99.11
HF Radio Vertical Monopole Signal Upset	6.34	15.85	16.72	17.29
Cell Handset Upset	1.60	1.90	2.21	2.49
Land Mobile Handset Damage	1.00	1.30	1.57	1.72

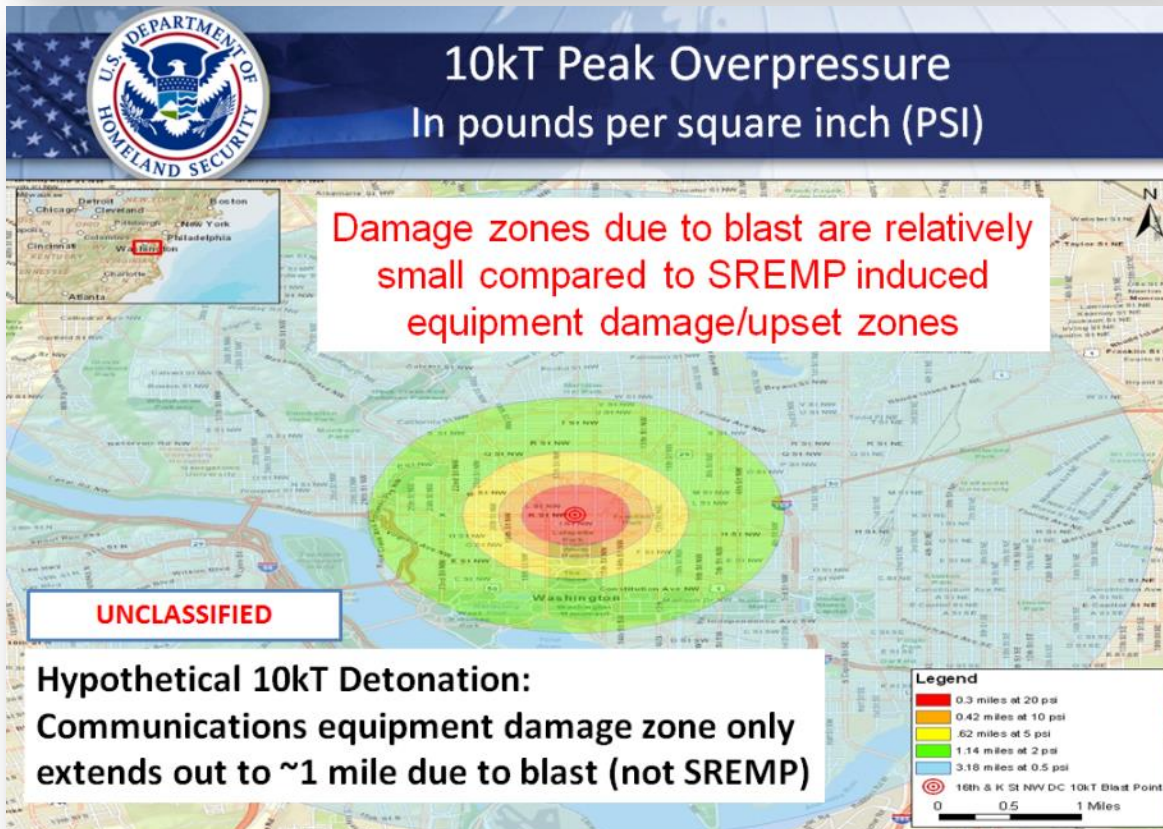



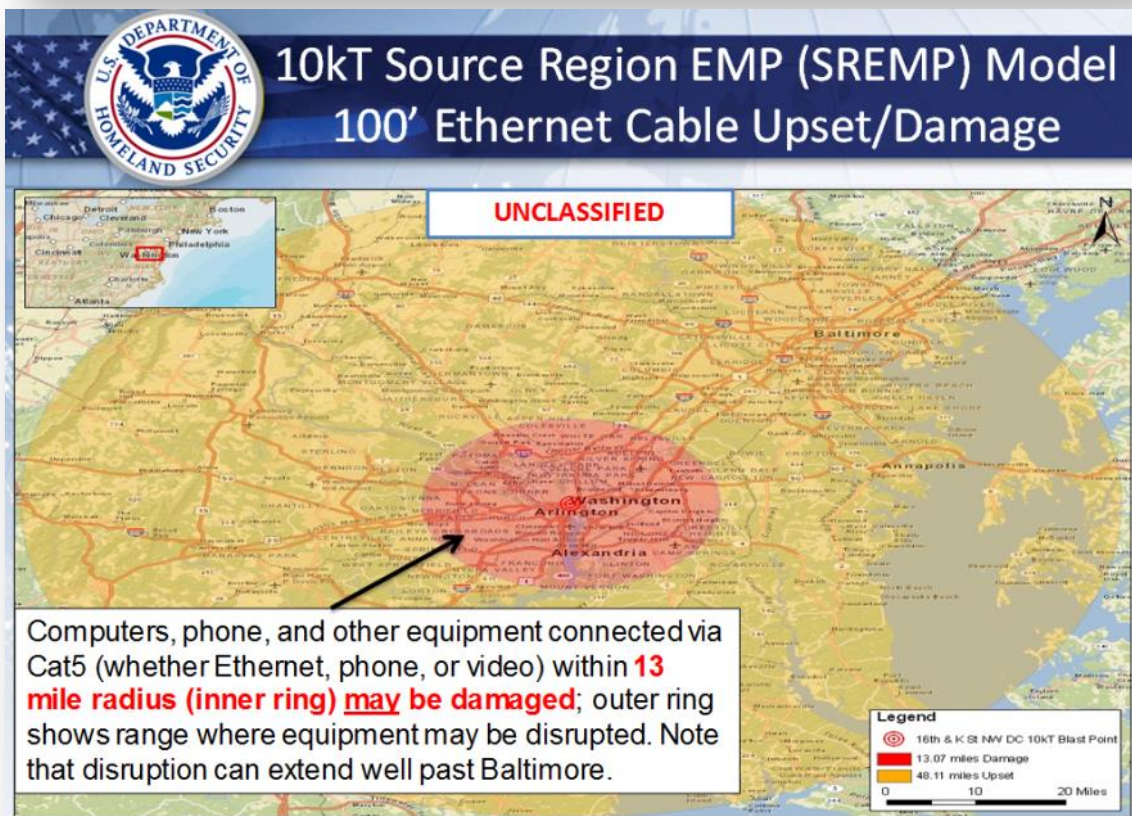
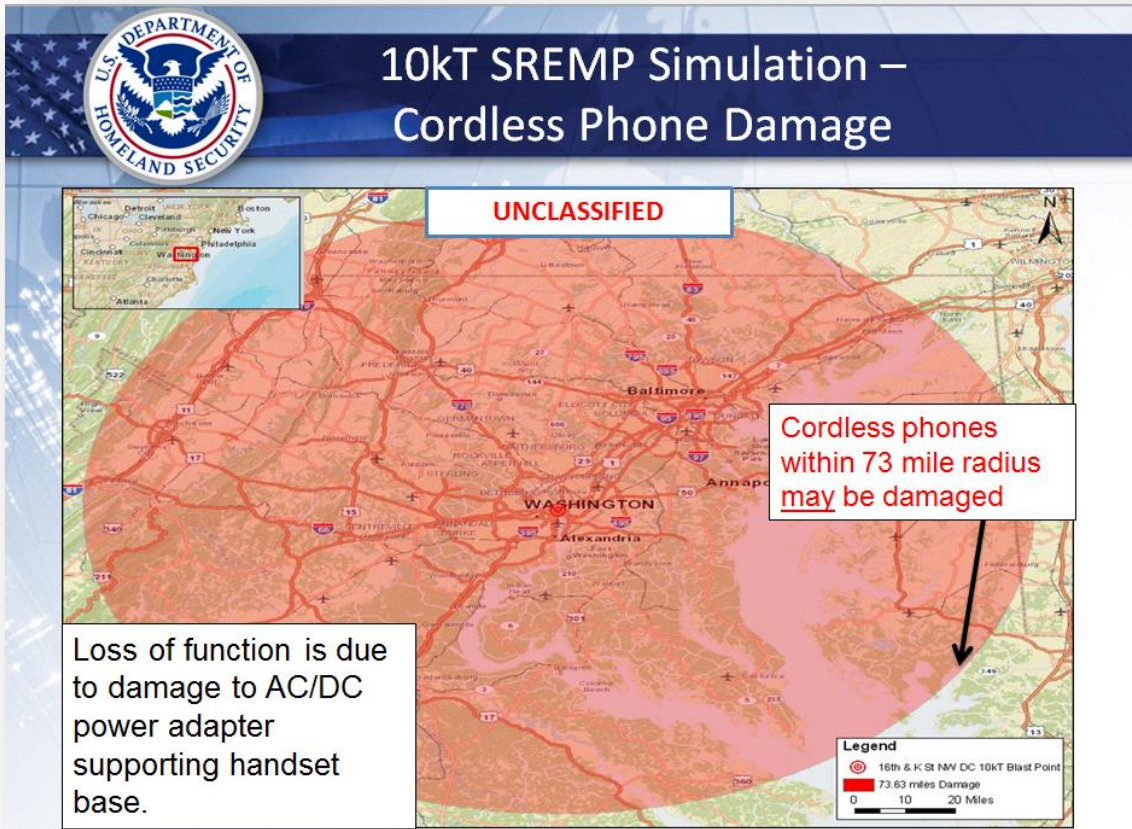



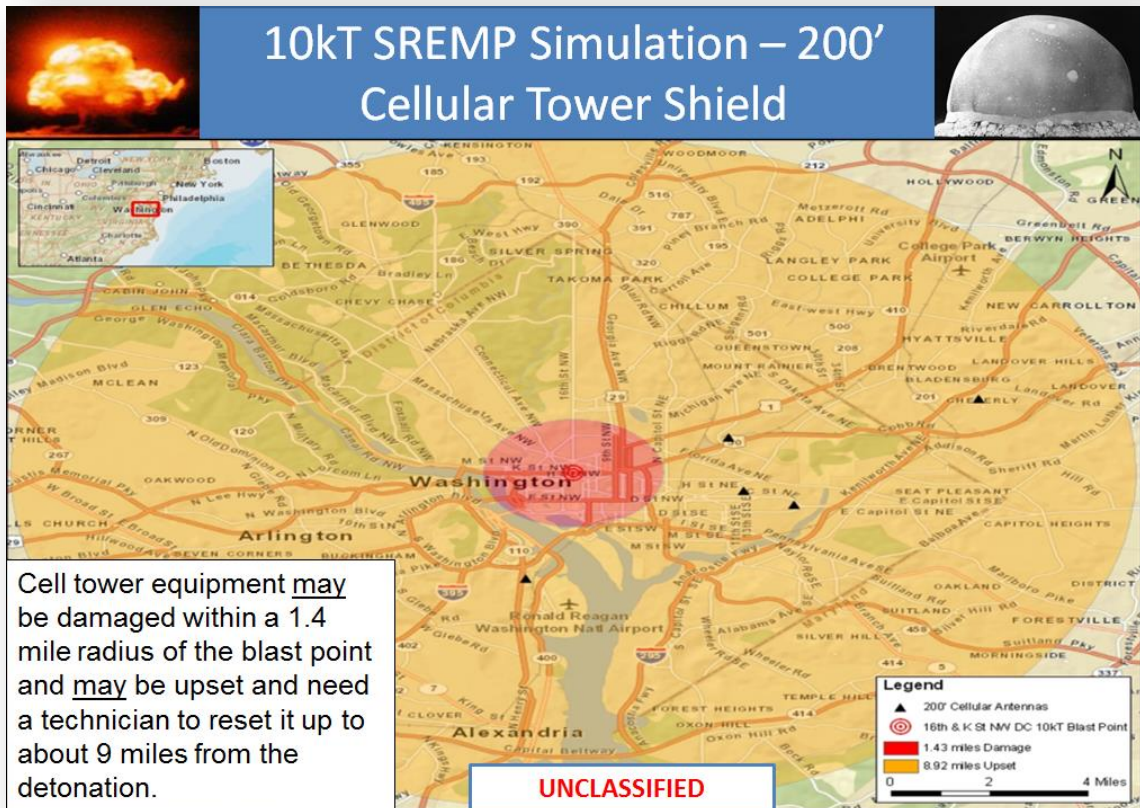
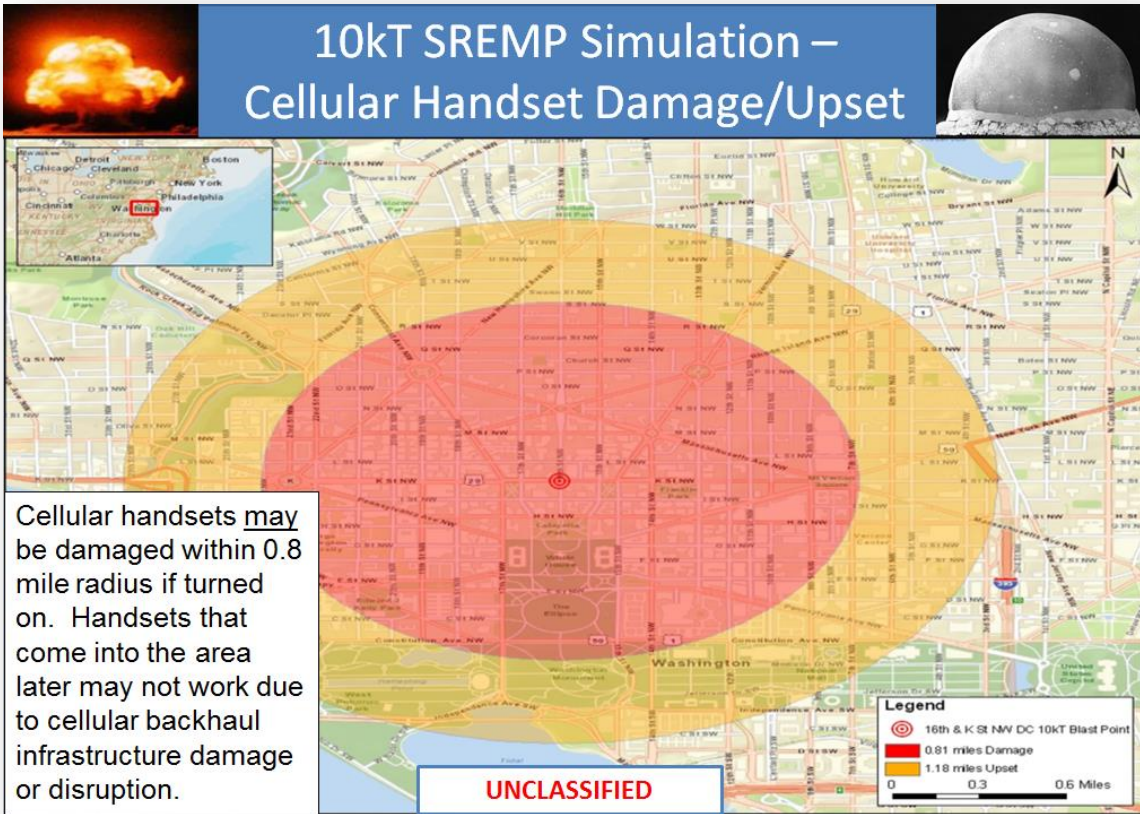



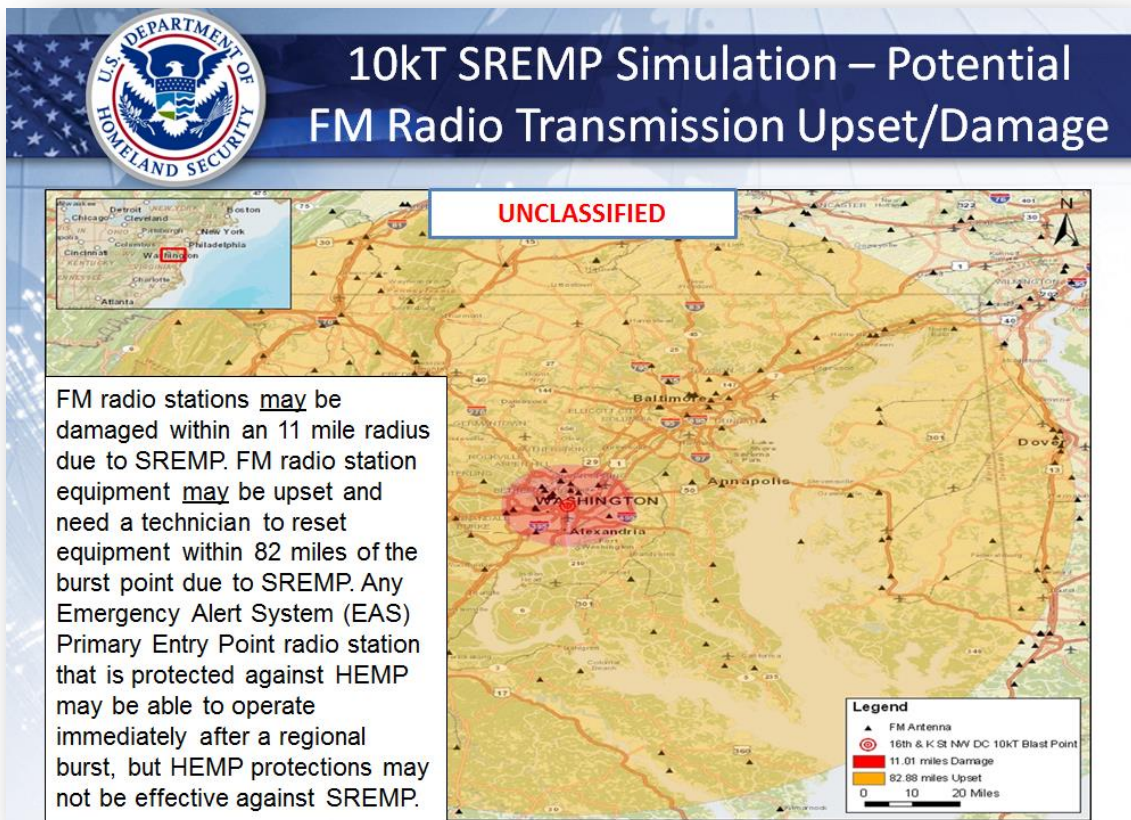



**SREMP consequences for infrastructures and communications**

- ❑ Widespread, long-term regional loss of power & communications
  - Catastrophic transformer failures at plants, substations, etc.
  - Power controls, relays, generators, computers are disrupted
  - Equipment connected to power or metallic data cables disrupted
- ❑ Consequences:
  - Immediate power outages in city/region complicates response
  - Loss of heating, air conditioning, lighting
    - Winter is worse case due to: (1) pipes bursting and (2) fires
  - Public panic due to food/water/essential service outages
  - Telecommunications failures widespread after a few hours
  - If near nuclear power plant, could risk Fukushima-like issues
  - Restoration/response hindered greatly by nuclear fallout/fires



## History of High Altitude EMP in USA



The July 1962 — Starfish Prime high altitude nuclear burst as seen through heavy cloud cover from Honolulu about 900 miles away. Aurora effects were observed for as long as 7 to 14 minutes in some areas.



The Starfish Prime air-glow aurora as seen at three minutes from a surveillance aircraft

UNCLASSIFIED



## History of HEMP – USA

- **1962: U.S. “Starfish Prime” High Altitude EMP (HEMP) Test**
  - At midnight (9 July) over Johnston Island, a 1.4 MT device was detonated at 400 km (~ 250 miles) altitude ; a ~ 14 kV/m EMP resulted at Johnston Island
  - At 100 nanoseconds, Hawaii experienced a 5.6 kV/m EMP
    - Blew fuses supporting ~ 300 street lights in Oahu (~ 900 miles away)
    - Damaged a microwave link that then shut down telephone service between Kauai to the other Hawaiian islands
    - Other: some car ignition systems fused and burglar alarms went off
  - Artificial radiation belt of trapped electrons damaged many satellites
    - Solar panels degraded; most satellites failed (within days to 6 months)
  - HF radio was disrupted for minutes to hours in the region; HF TRX’s damaged
- **A similar burst over the central USA today would likely shut down commercial power and communications in large regions for months or longer**

UNCLASSIFIED





## High Altitude EMP (HEMP)

### Most significant EMP; has 3 components

1. **E1** is the fast (less than microsecond) and powerful pulse that can destroy computers and communications equipment and disrupt power grids
2. **E2** occurs from 1 microsecond out to 1 second and is generated by gammas produced by weapon neutrons and is less powerful than the E1 pulse
  - The main risk with the E2 component is that it immediately follows the E1 component, which may have damaged the lightning protection devices that would normally also have protected against E2
3. **E3** is a slow pulse that arrives after 1 second and can last several minutes
  - E3 can penetrate the ground and water; similar to solar storm EMP
  - E3A (Blast) occurs in 1 – 10 seconds; E3B (Heave) in 10 – 300 seconds
  - E3 can produce damaging surge currents in long electrical conductors like power lines or undersea cables

See Meta-R-319 through Meta-R-324 for more information on the various types of EMP

UNCLASSIFIED

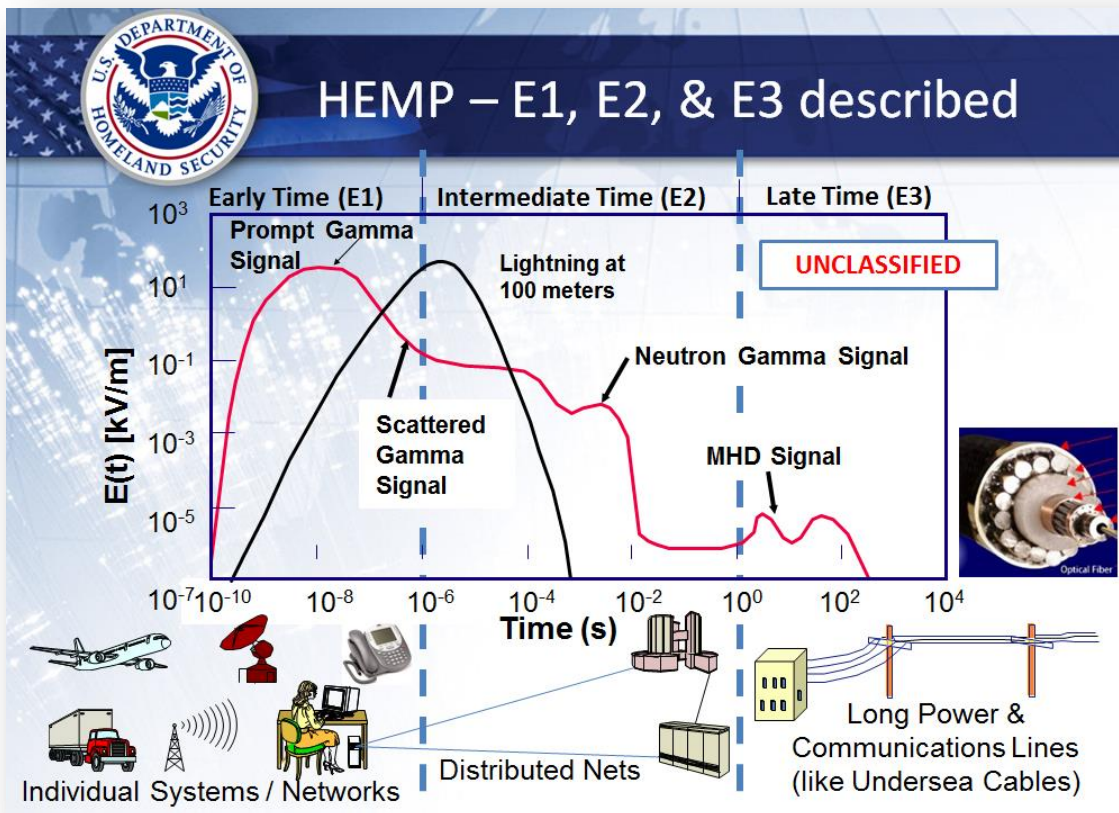

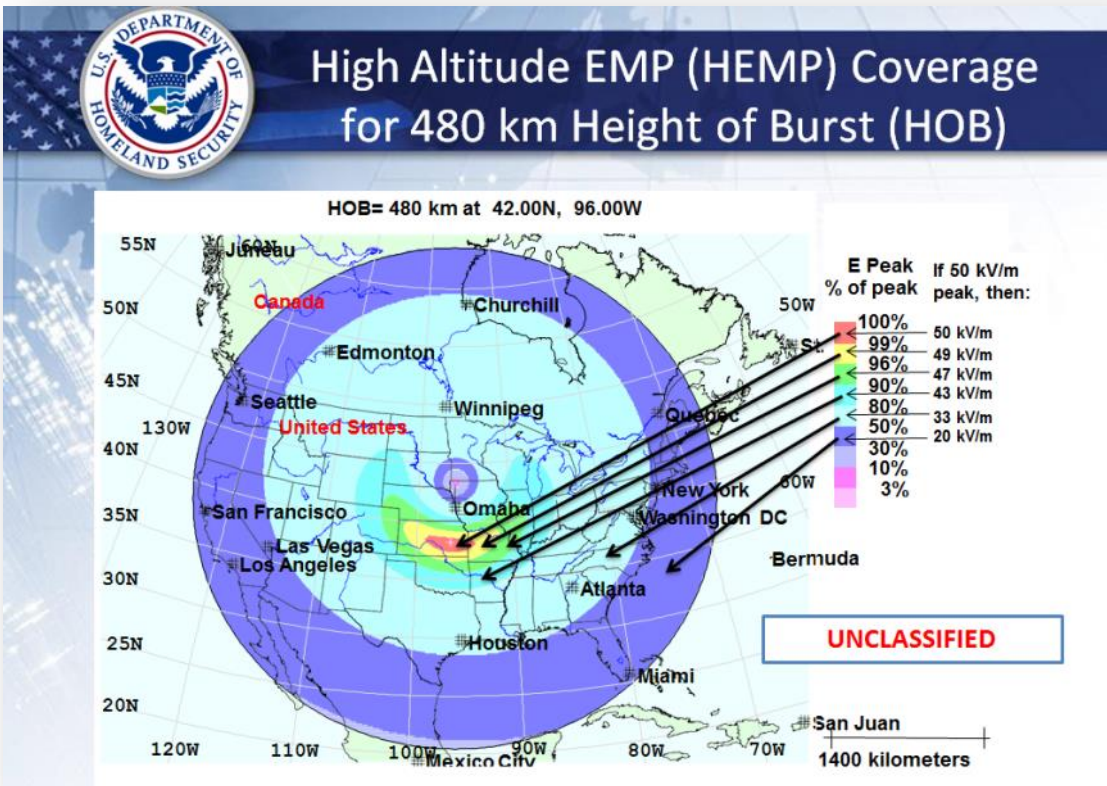
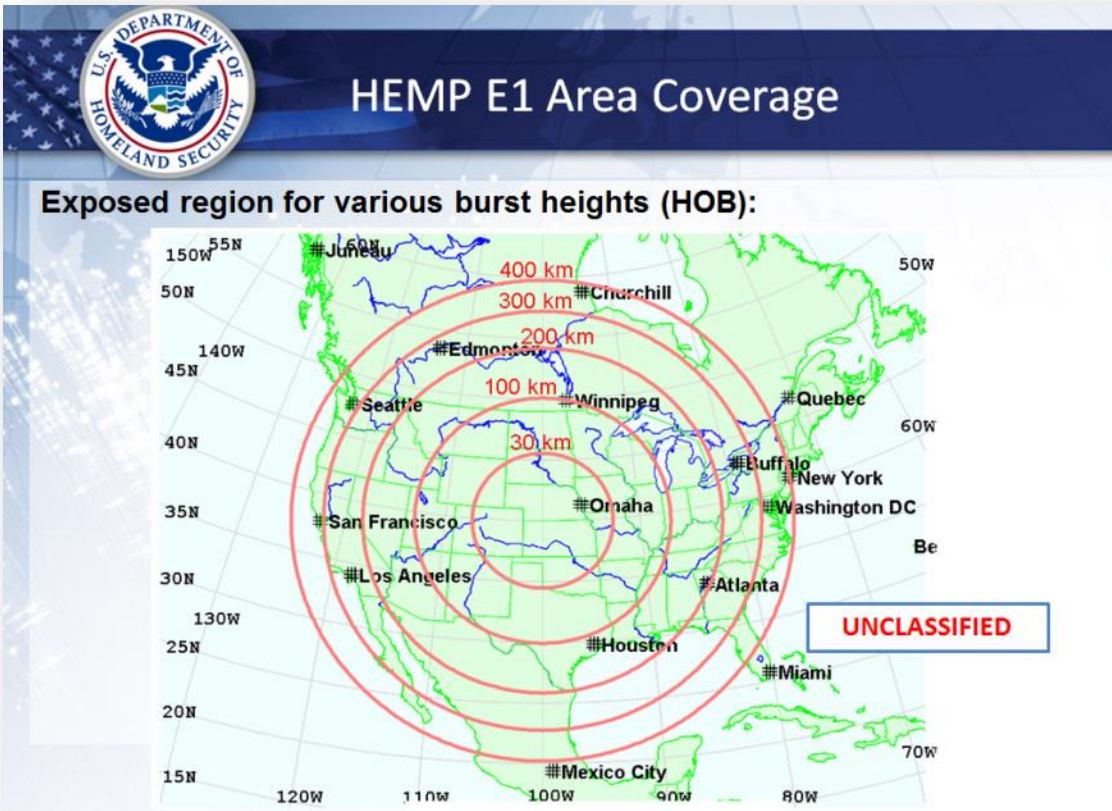



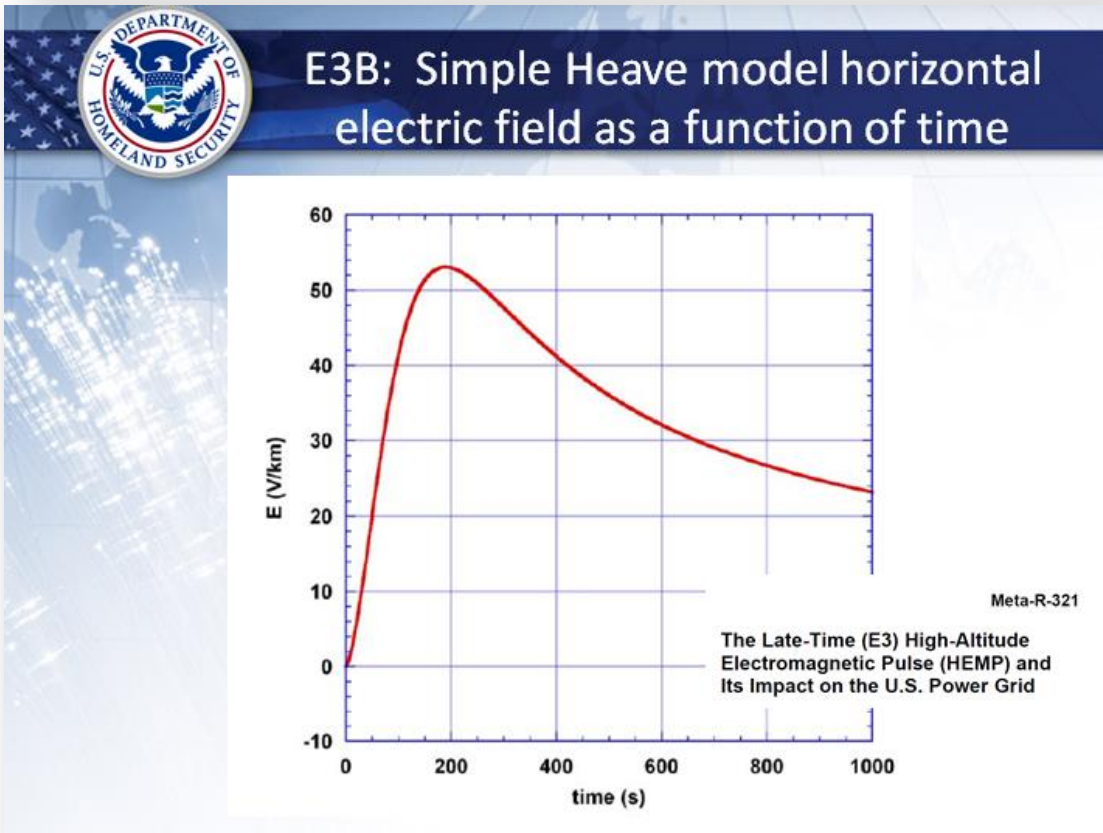
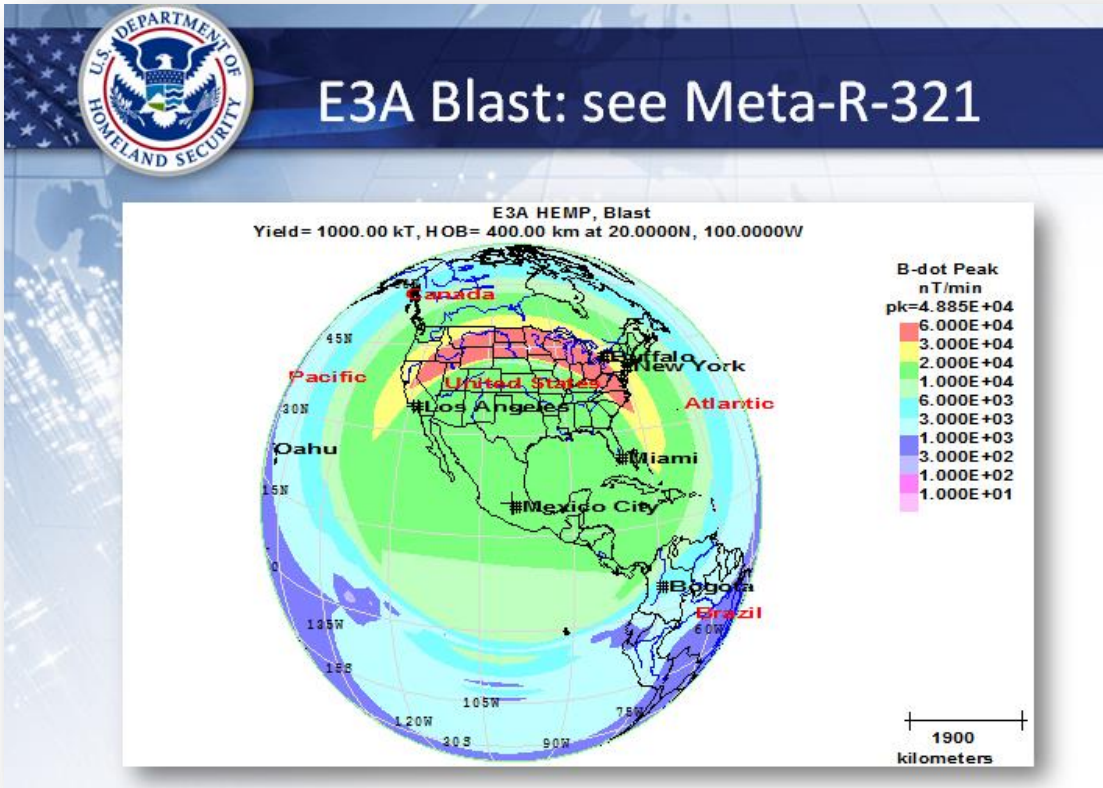

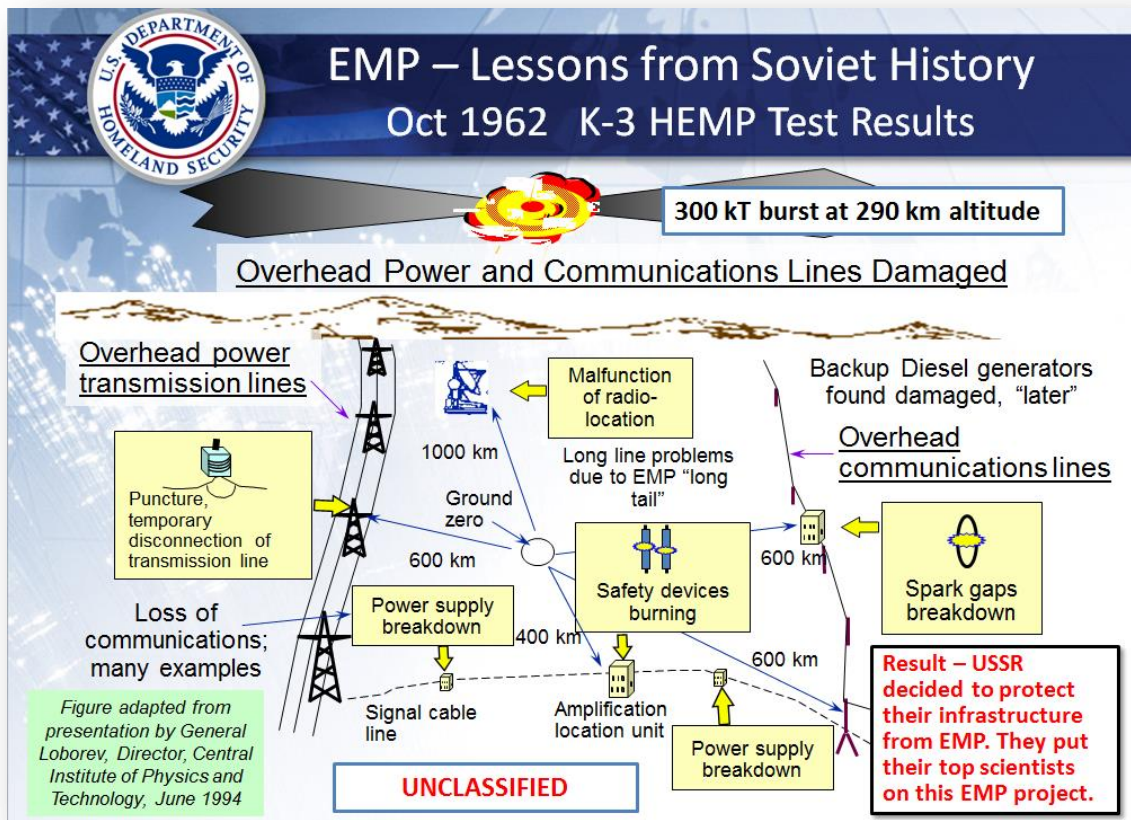

**What can EMP do?**

**Testimony of the Chairman of the EMP Commission:** "Depending on the specific characteristics of the EMP attacks, unprecedented cascading failures of major infrastructures could result. In that event, a regional or national recovery would be long and difficult, and would seriously degrade the safety and overall viability of our Nation. ... The recovery of any one of the key national infrastructures is dependent upon the recovery of others. The longer the outage, the more problematic and uncertain the recovery will be. It is possible for the functional outages to become mutually reinforcing until at some point the degradation of infrastructure could have irreversible effects on the country's ability to support its population." [www.empcommission.org/docs/GRAHAMtestimony10JULY2008.pdf](http://www.empcommission.org/docs/GRAHAMtestimony10JULY2008.pdf)

**EMP Commission finding:** "The Congressional EMP Commission estimates that, given the nation's current unpreparedness, within one year of an EMP attack, two-thirds of the U.S. population — 200 million Americans — would probably perish from starvation, disease and societal collapse." [www.washingtontimes.com/news/2012/dec/19/north-korea-emp-attack-could-destroy-us-now/#ixzz2TEqorSvV](http://www.washingtontimes.com/news/2012/dec/19/north-korea-emp-attack-could-destroy-us-now/#ixzz2TEqorSvV)

**UNCLASSIFIED**





## High-Altitude Electromagnetic Pulse Effects on Electronics

- There are no similar natural effects that routinely would be as strong – but HEMP is somewhat like:
  - Electrostatic Discharge (ESD) fields have some similarities to early part of HEMP – E1
  - Solar magnetic storms are similar to late part of HEMP – E3
- HEMP is of concern for electronic equipment – upset or damage

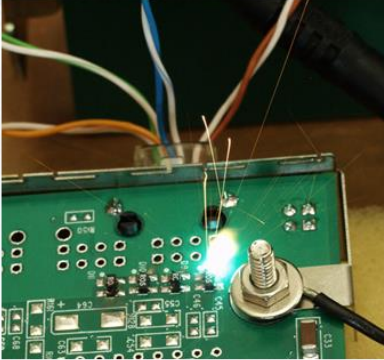

Network interface “blowing up” – here from a SCADA unit

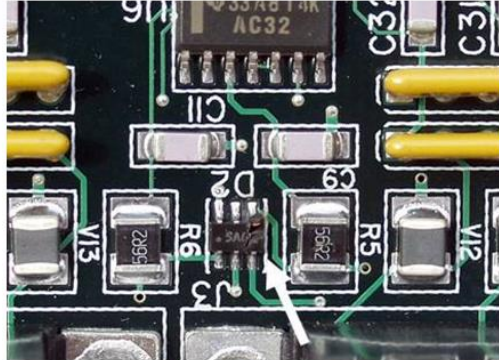

Damaged part from pulsing of a timing port in a SCADA unit

(SCADA = “supervisory control and data acquisition”, electric power grid controls.)

**UNCLASSIFIED**



## More Damage Examples, NIC Cards

### NIC = Network Interface Cards (Ethernet card for PCs)



In-line capacitor completely blown off a NIC.

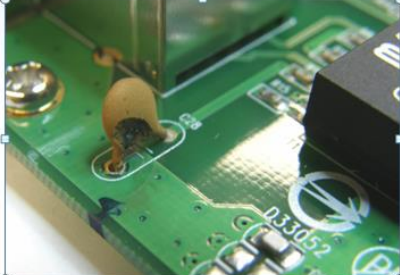

A ceramic capacitor with a piece blown off; from a NIC.



The main IC of a NIC – with the lid scorched and deformed.

**UNCLASSIFIED**



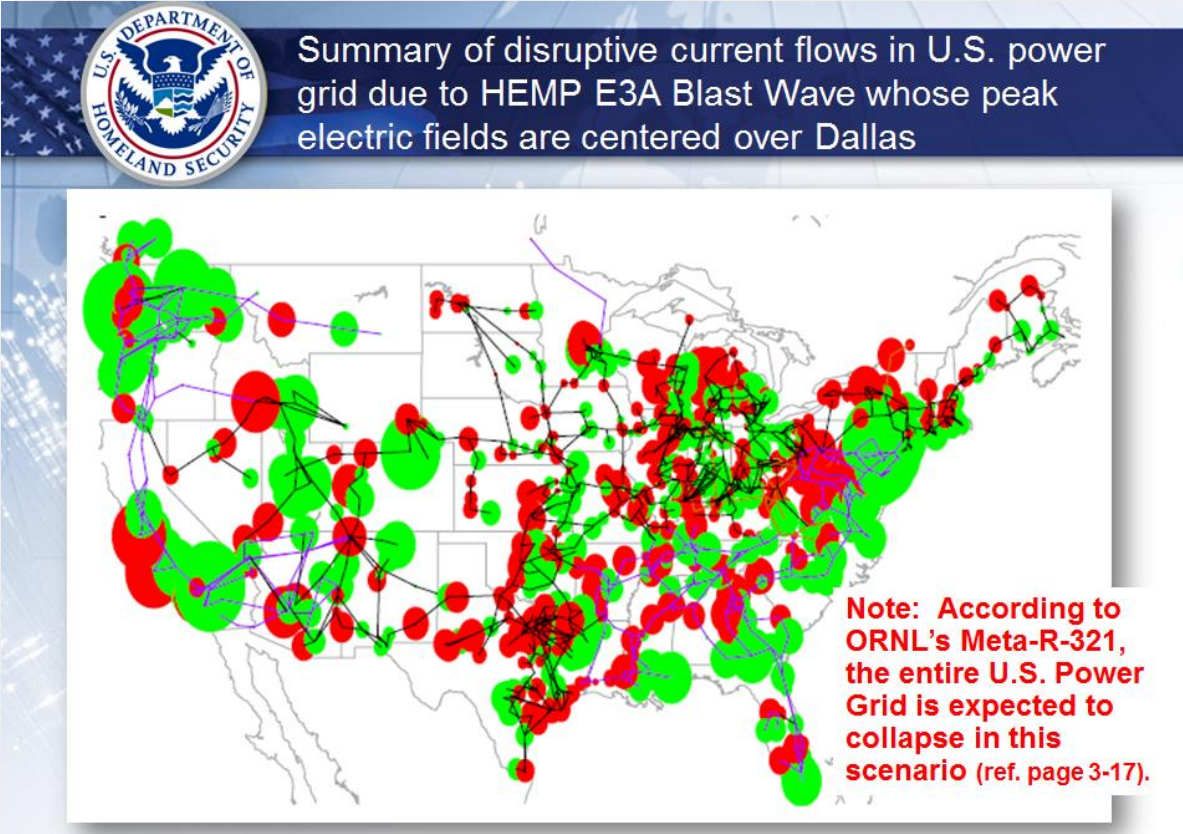

**The size of the circles indicates the magnitude of the current flowing through high voltage transformers and their polarity (in or out of transformers in a substation)**

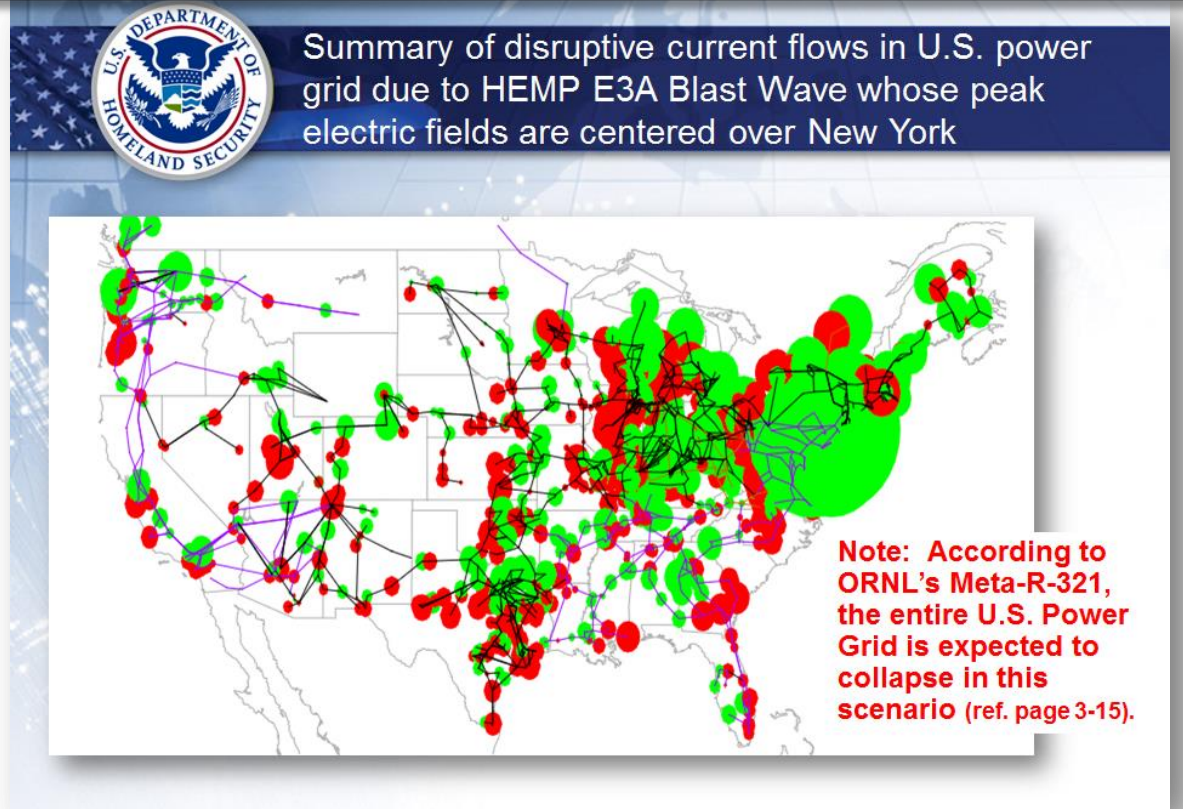



## E1 HEMP Waveform Properties

IEC E1 HEMP Waveform Properties	
Characteristic	Value
Waveform peak	$E_{\text{peak}} = 50,000 \text{ V/m}$
Spectrum peak	$E_{\text{low freq}} = 0.00152 \text{ V/m/Hz}$
Waveform peak power	$P_{\text{peak}} = 6.64 \times 10^6 \text{ W/m}^2$
Spectrum peak power	$P_{\text{low freq}} = 6.11 \times 10^{-9} \text{ W/m}^2/\text{Hz}$
Total energy	$W_{\text{total}} = 0.115 \text{ J/m}^2$
Time of peak	$t_{\text{peak}} = 4.84 \text{ ns}$
Rise time, 10% to 90% of peak	$t_{10-90} = 2.47 \text{ ns}$
Pulse width, full width at half maximum	$\text{FWHM} = 23.0 \text{ ns}$
Pulse width, total energy over peak power	$W_{\text{total}} / P_{\text{peak}} = 17.3 \text{ ns}$
Spectrum width, total energy over peak spectrum power	$W_{\text{total}} / P_{\text{low freq}} = 18.8 \text{ MHz}$

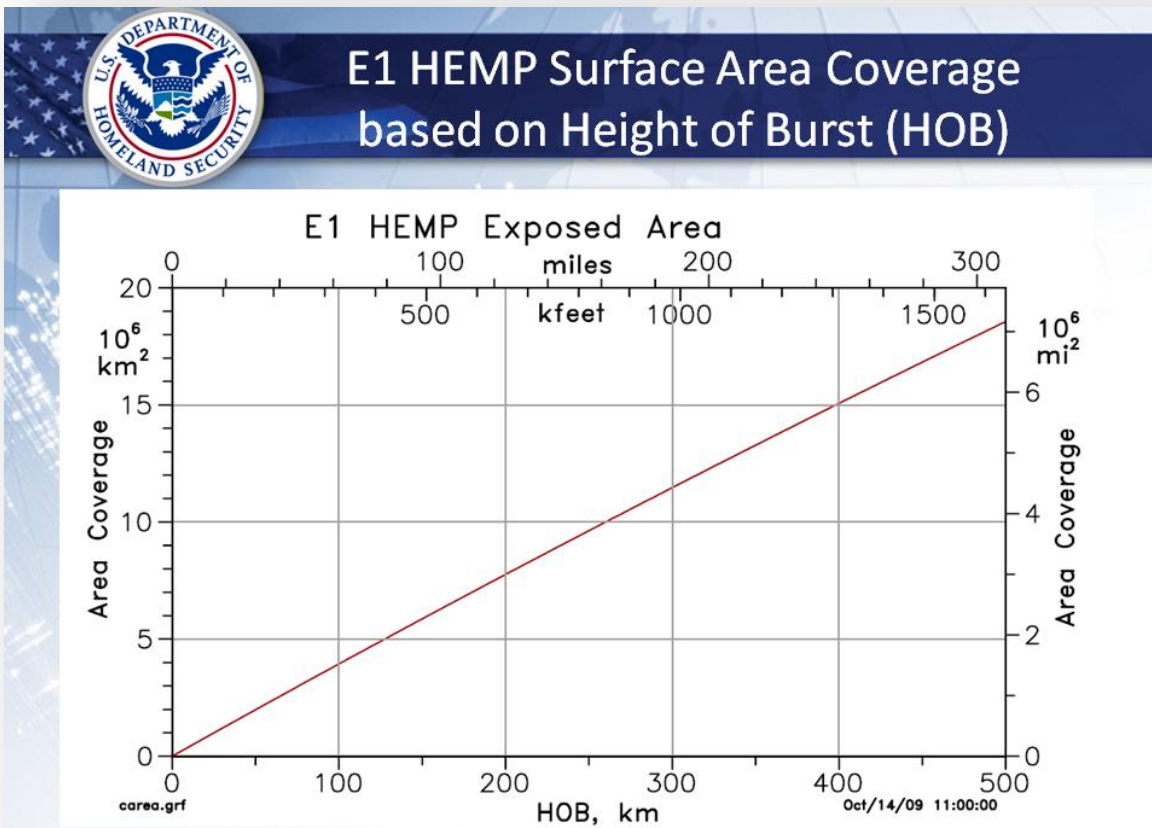



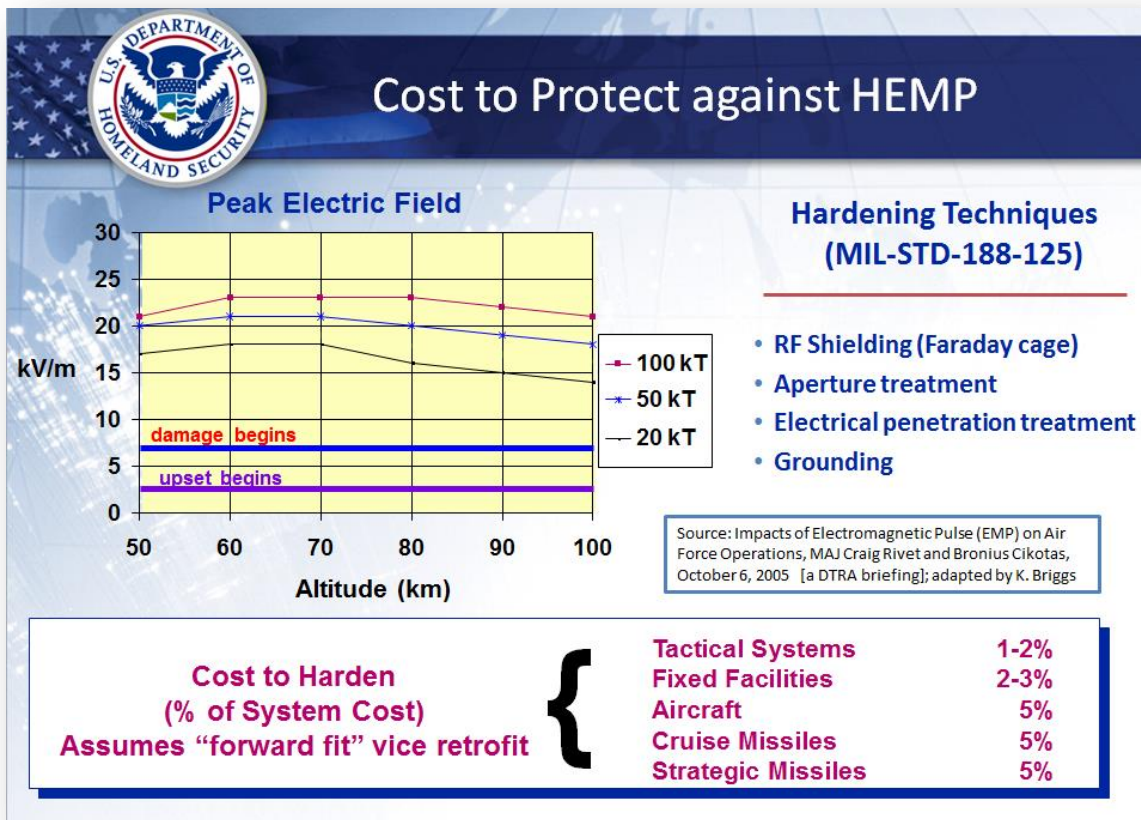

## E1 HEMP Damage to 7.2kV/25kVA Power Distribution Transformers (source: Meta-R-320)

XFMR	Shots #@kV	Peak Voltage (kV)	Time to Peak (ns)	Surge Arrester	Notes	Result
ZS1						Pulser calibration
ZS2	1@400	264	618	No	(1)	T-T failure
ZS3	2@400	288	668	No	(2)	HV-LV failure
ZS4	2@400	280	600	No	(1)	L-L failure
ZS5	1@400	272	550	No	(2)	HV-LV failure
ZS6	2@400	290	643	No	(1)	No damage
ZV1	1@400	296	601	No	(1)	No damage
ZV2	1@400	304	592	No	(2)	HV-LV failure
ZV3	2@400	110	100	Yes	(3)	No damage
ZV4	2@500	110	100	Yes	(3)	No damage
ZV4	2@780	116	110	Yes	(3)	No damage
XV1	1@400	272	500	No	(2)	HV-LV failure

(1) External flashover on HV bushings: T-T failure denotes turn-to-turn failure; L-L failure denotes line-to-line failure  
 (2) No external flashover; HV-LV failure denotes a high-voltage winding flashover to the low-voltage winding  
 (3) Surge arrester operation and no external flashover





## Generic electric grid substation building shielding against HEMP E1

Building Shielding		
dB	Type	Example
0	Transparent	Wood
5	Poor	Masonry
10	Moderate	Concrete
20	Good	Metal siding
30	Metal	All-metal



Source: Meta-R-389, Preliminary Appraisal of HEMP Effects on Electrical Substations by Dr. Edward B. Savage and Dr. William A. Radasky, Metatech, page 5)



## Electric grid substation equipment cabling vulnerability levels for E1 HEMP transients

Substation Equipment Vulnerability Levels, as Peak kV (kilovolts)					
Equipment			Substation	Vulnerability, kV	
#	Type	Description		Upset	Damage
1	Well protected	Very good protection at device external ports. Examples: Electronic protection relays and SCADA units.	Old and simple or New and hardened	5	10
2	Network interface	These are ubiquitous in today's modern world, and can have long cables (giving higher coupling levels).	Typical	2	5
3	Computer or PLC	Examples: PC computers and process controllers (PLC = programmable logic controllers).	Multi-functional	1	1

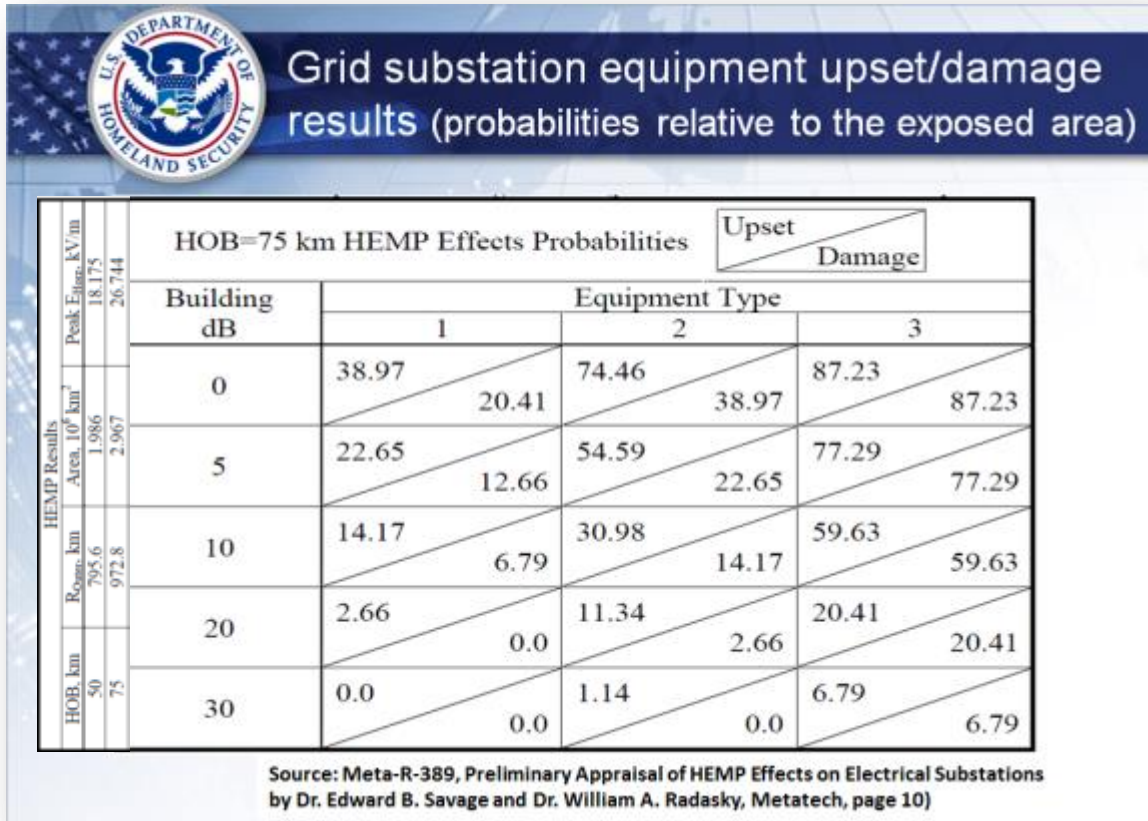
Source: Meta-R-389, Preliminary Appraisal of HEMP Effects on Electrical Substations by Dr. Edward B. Savage and Dr. William A. Radasky, Metatech, page 7)





## Intentional Electromagnetic Interference (IEMI) and Radio Frequency (RF) Weapons

[Graphic source: IEEE Spectrum Sep 2014]



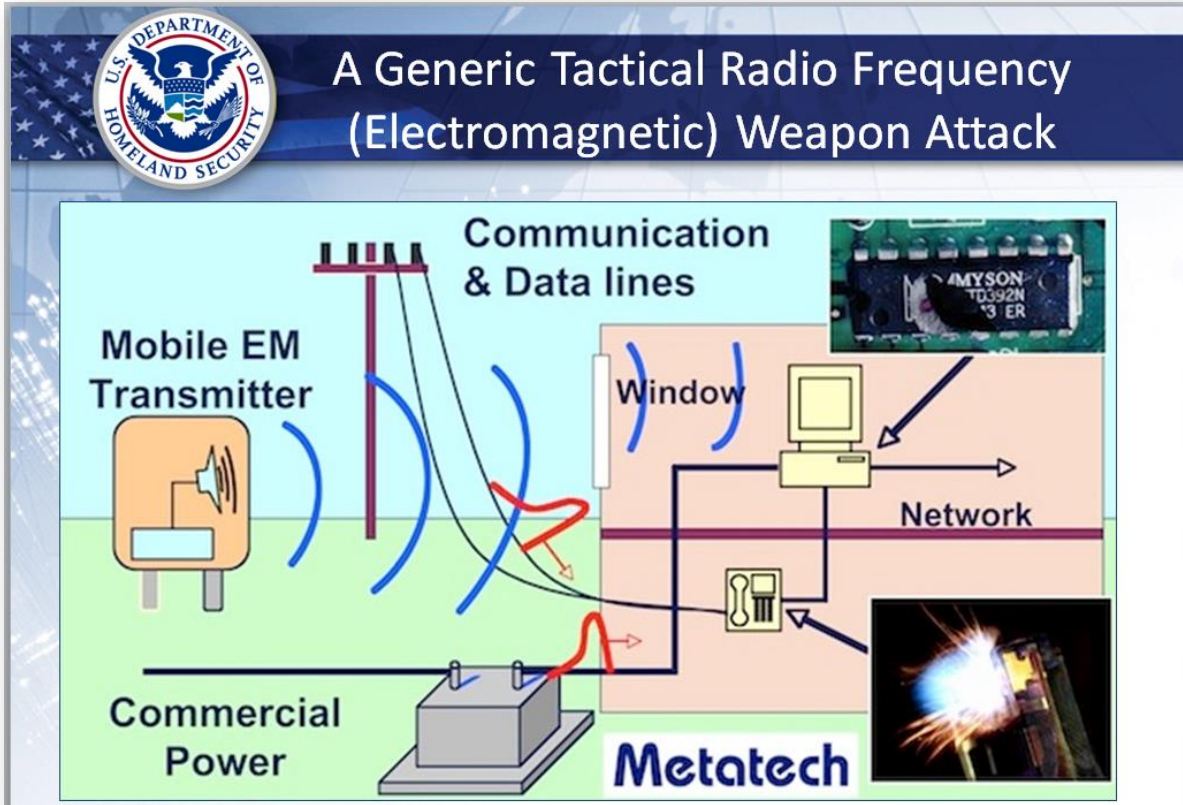



**Examples of Tactical Radio Frequency Electromagnetic (EM) Weapons**

U.S. DEPARTMENT OF HOMELAND SECURITY

JOLTIRA 10' Hyperband Emitter

Large Truck Mounted Narrowband, High Pulse Repetition Frequency Mode Microwave (NB HPRF/M) Source

Ultra-wideband Pulser and Impulse Radiating Antenna

Multiple Pulse Burst Resonator (DS220MP)

Pickup truck mounted Radar, HPRF/M Source

Diehl DS110B EM Weapon

Performance Data DS220MP

Rep Rate	100 Hz
Ballistic Energy	100 J
Frequency	50-150 MHz
Directional	omnidirectional
Non-Lethal	

Application (Example)

- Communication, Command and Control Centers
- Air Defense Sites
- Infrastructure

High Power Microwave Technologies DIEHL

600 kV Marx generator

Frequency control

Tunable antenna

HV supply

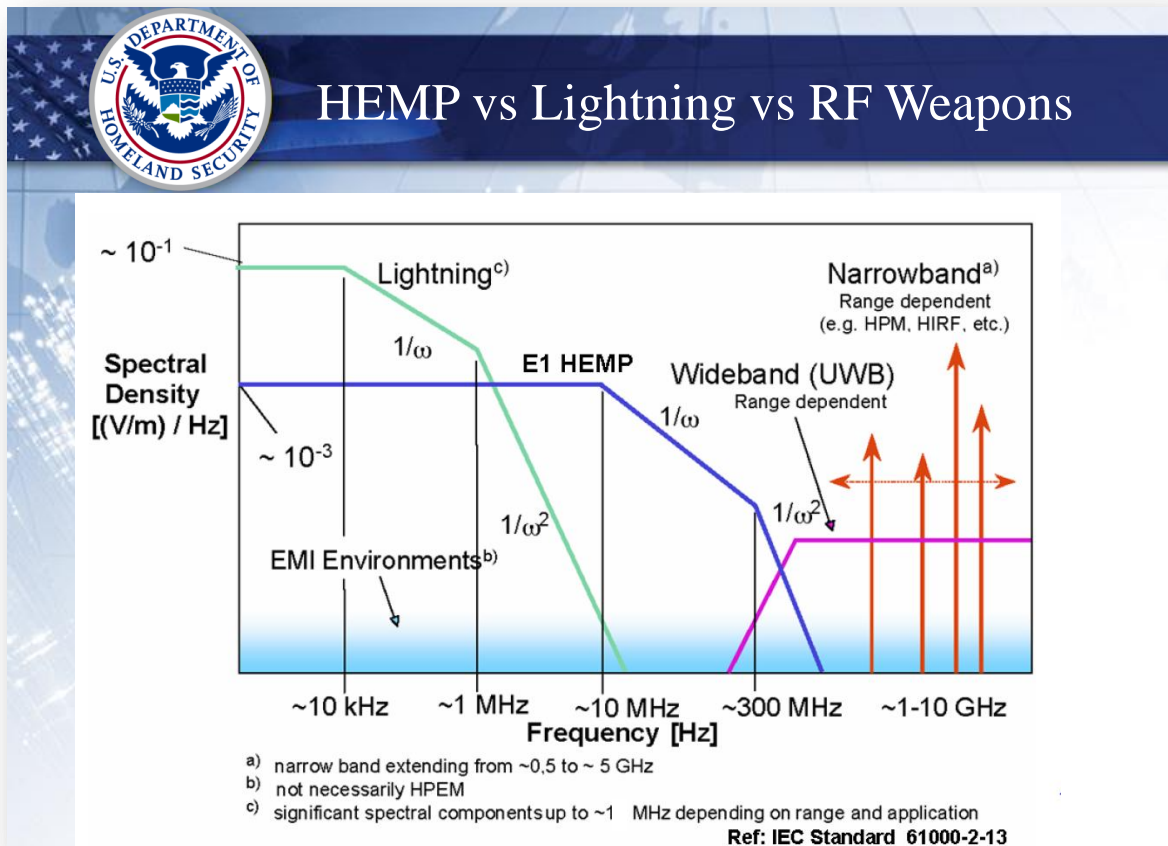

**Range/Levels of Radiated Electric Fields (from EM Weapons per IEC 61000-2-13)**

Frequency	Range	Variation of E-field with an antenna aperture of 10 m <sup>2</sup> and output powers of 2 kW to 20 MW	
500 MHz	300 m	15,23 V/m	to 1,52 kV/m
	1 km	4,57 V/m	to 457 V/m
1 GHz	300 m	30,43 V/m	to 3,04 kV/m
	1 km	9,13 V/m	to 913 V/m
2 GHz	300 m	60,90 V/m	to 6,09 kV/m
	1 km	18,27 V/m	to 1,83 kV/m
3 GHz	300 m	91,33 V/m	to 9,13 kV/m
	1 km	27,40 V/m	to 2,74 kV/m

Note that standard nuclear EMP protection may not provide adequate protection against the higher frequency (beyond 10 GHz), repeated pulses (can be 100s of pulses per second), IEMI weapon threats





## Comparison of E1 HEMP and Radio Frequency/IEMI Threats

- IEC E1 HEMP
- Severe and Moderate Hyperband IEMI

Threat Environments	
Threat	Description
E1 HEMP	IEC 61000-2-9 E1 HEMP Peak = 50 kV/m Rise time (10% - 90%) = 2.5 ns Pulse width (FWHM*) = 23 ns Number of pulses = 1 or 2
Severe IEMI	JOLT-like Peak rE = 5 MV Rise time (10% - 90%) = <100 ps Pulse width (FWHM*) = <1 ns Number of pulses = ~600/s
Moderate IEMI	1/10 <sup>th</sup> of Severe IEMI Peak rE = 500 kV Rise time (10% - 90%) = <100 ps Pulse width (FWHM*) = <1 ns Number of pulses = ~600/s



## Internal Voltage Level Examples with Moderate and Severe IEMI Threats

Note: Shld = Shield; Cble = cable length in meters; R = stand-off range in meters  
JOLT = Severe IEMI; Briefcase = Moderate IEMI

[Source: Adapted from Metatech briefing for DHS, The Intentional Electromagnetic Interference (IEMI) Threat, Effects and Protection, prepared for National Coordinating Center for Communications, 27 Jan 2015]

Induced Peak Voltages for Measurement Sites										
Location		Parameters			Peak Cable Voltage, kV					
		Shld	Cbl	R	Worst Case Cable (1%)			Average Cable (50%)		
Site	Room	dB	m	m	HEMP	IEMI		HEMP	IEMI	
						Severe	Moderate		Severe	Moderate
Substation	Comm	20	3	110	14.90	98.41	9.84	9.0	25.87	2.59
	345 kV Relay	30	3	110	7.95	4.32	0.43	4.80	2.00	0.20
				255	2.51	1.37	0.14	1.52	0.63	0.06
	161 kV	25	3	130	2.51	0.59	0.06	1.52	0.27	0.03
Control Center	Comm	20	3	10	4.47	2.06	0.21	2.70	0.95	0.10
	Control	20	10	30	7.95	47.55	4.76	4.80	22.05	2.21
	EMS	15	3	10	26.50	29.17	2.92	16.00	7.67	0.77
Back-Up Power Facility	Control	25	3	5	14.14	84.56	8.46	8.54	39.21	3.92
				20	4.47	53.48	5.35	2.70	24.80	2.48
	Generator 1	20	10	10	4.47	13.37	1.34	2.70	6.20	0.62
				20	26.50	87.50	8.75	16.00	23.00	2.30
	Generator 2	25	10	10	26.50	43.75	4.38	16.00	11.50	1.15
				30	14.90	49.20	4.92	9.00	12.93	1.29
	Generator 3	15	10	10	14.90	16.40	1.64	9.00	4.31	0.43
				20	14.90	49.20	4.92	9.00	12.93	1.29

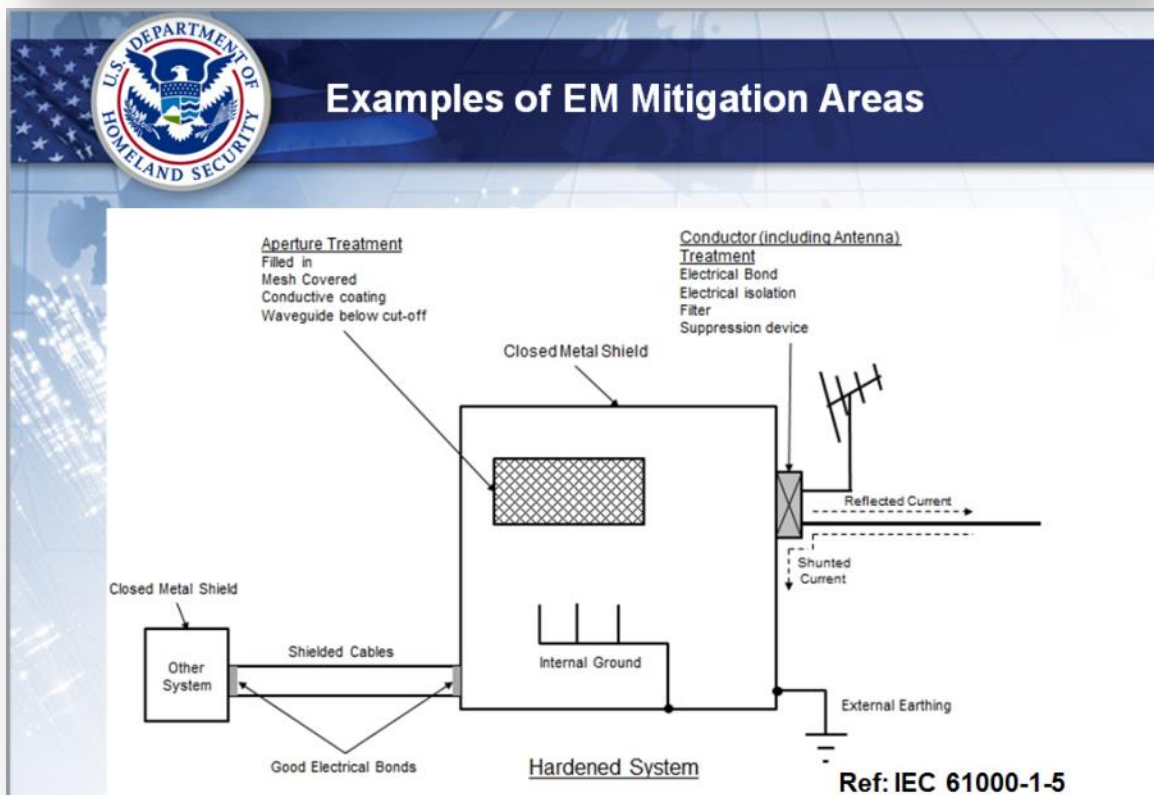
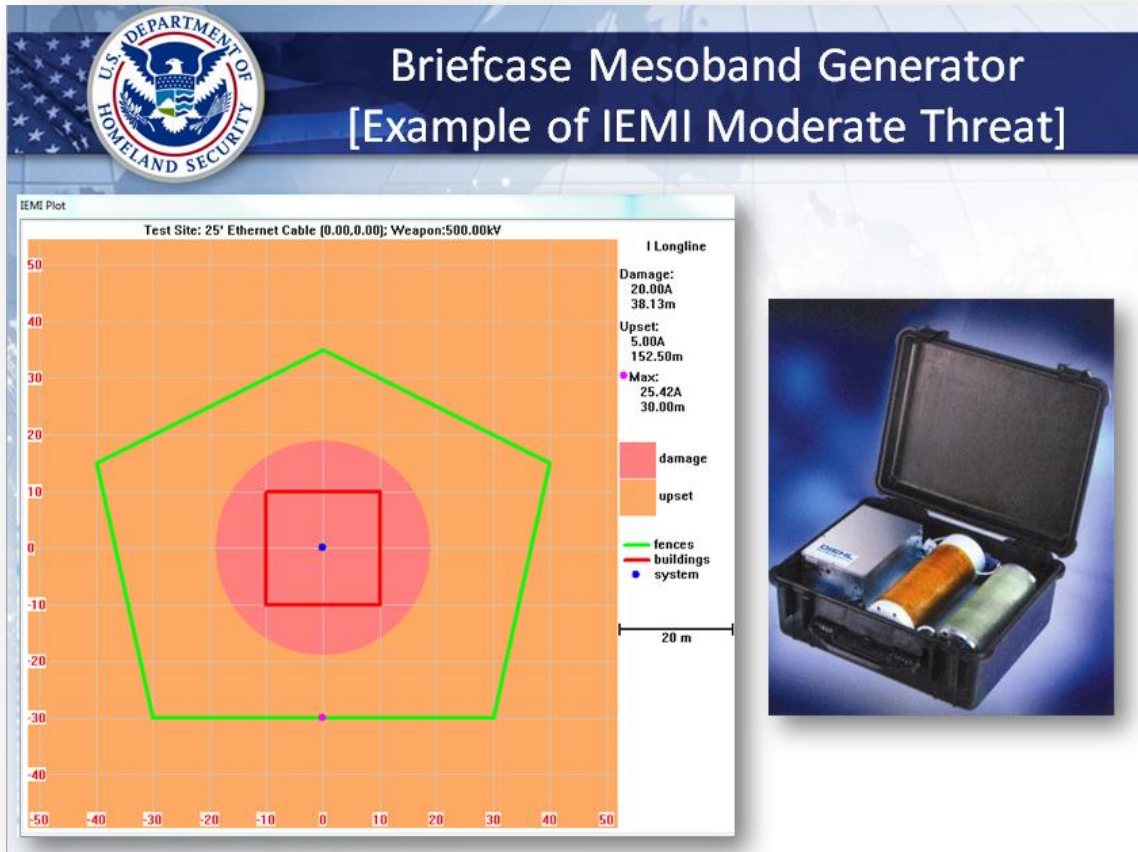





## Internal Cable Management



Segregation, separation and grouping of cables by function:

- Power cables
- Data communications (e.g. IT networks)
- Auxiliary circuits (e.g. door openers, fire alarm)
- Sensitive circuits (e.g. measurement and instrumentation)

Non-metallic type cables are a solution

### Cable Routing/Location

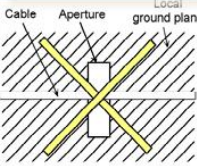

Incorrect

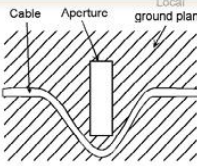

Correct

(a) Cable crossing a slot or aperture

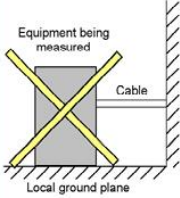

Incorrect

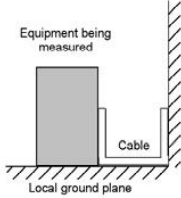

Correct

(b) Cable routed between equipment

Source: Dr. Richard Hoad, UK as adapted from Metatech briefing to DHS 27 January 2015



## Summary of IEMI Mitigation Options

- **Increase the EM shielding effectiveness of building containing electronics**
- **Increase the standoff distances where EM weapons may be placed using physical security measures such as fences to decreases the incident EM fields at the buildings**
- **Use EM alarms to monitor the EM environment to watch for the beginning and continuation of an attack**
- **If high level EM fields still may appear at the location of sensitive electronics, then several major hardening approaches should be considered**
  - Enclose internal equipment in shielded racks or rooms
  - Reduce the field coupling to the cables
  - Reduce the impact of coupled currents and voltages on the equipment